



**Platforma pilot pentru asigurarea evaluării calității
și vizualizarea conținutului științific digital din RM, SCIFORM**

Codul proiectului 15.817.06.13A

Livrabil

Descrierea tehnică a modelului de date

Versiune: 1.0

Data: 06.12.2016

Licența Creative Commons:



Autor(i): Andrei RUSU

Rodica CUJBA



Elements	Groups	Complex types	Simple types
CERIF	cfCoreClass_Group cfCoreClassWithFraction_Group	cfAmount_Type cfCite_Type cfCite_Class_Type cfCiteDescr_Type cfCiteTitle_Type cfClass_Type cfClass_Class_Type cfClassDef_Type cfClassDescr_Type cfClassEx_Type cfClassScheme_Type cfClassScheme_ClassScheme_Type cfClassSchemeDescr_Type cfClassSchemeName_Type cfClassTerm_Type cfCoreClass_Type cfCoreClassWithFraction_Type cfCountry_Type cfCountry_Class_Type cfCountryName_Type cfCurrency_Type cfCurrency_Class_Type cfCurrencyEntName_Type cfCurrencyName_Type cfCV_Type cfCV_Class_Type cfDC_Type cfDCAudience_Type cfDCContributor_Type cfDCCoverage_Type cfDCCoverageSpatial_Type cfDCCoverageTemporal_Type cfDCCreator_Type cfDCDate_Type cfDCDescription_Type cfDCFormat_Type cfDCLanguage_Type cfDCProvenance_Type cfDCPublisher_Type cfDCRelation_Type cfDCResourceIdentifier_Type cfDCResourceType_Type cfDCRightsHolder_Type cfDCRightsMM_Type cfDCRightsMMAccessRights_Type cfDCRightsMMLicense_Type cfDCSource_Type cfDCSubject_Type cfDCTitle_Type cfEAddr_Type	cfGender_Type cfld_Type cfTrans_Type

[cfEAddr Class Type](#)
[cfEvent Type](#)
[cfEvent Class Type](#)
[cfEvent Event Type](#)
[cfEvent Fund Type](#)
[cfEvent Indic Type](#)
[cfEvent Meas Type](#)
[cfEventDescr Type](#)
[cfEventKeyw Type](#)
[cfEventName Type](#)
[cfFDCRightsMM Pricing Type](#)
[cfFDCRightsMM Privacy Type](#)
[cfFDCRightsMM Rights Type](#)
[cfFDCRightsMM Security Type](#)
[cfFedId EmbType](#)
[cfFedId Type](#)
[cfFedId Class Type](#)
[cfFund Type](#)
[cfFund Class Type](#)
[cfFund Fund Type](#)
[cfFund Indic Type](#)
[cfFund Meas Type](#)
[cfFundDescr Type](#)
[cfFundKeyw Type](#)
[cfFundName Type](#)
[cfIndic Type](#)
[cfIndic Class Type](#)
[cfIndic Indic Type](#)
[cfIndic Meas Type](#)
[cfIndicDescr Type](#)
[cfIndicKeyw Type](#)
[cfIndicName Type](#)
[cfLang Type](#)
[cfLang Class Type](#)
[cfLangName Type](#)
[cfMeas Type](#)
[cfMeas Class Type](#)
[cfMeas Meas Type](#)
[cfMeasDescr Type](#)
[cfMeasKeyw Type](#)
[cfMeasName Type](#)
[cfMetrics Type](#)
[cfMetrics Class Type](#)
[cfMetricsDescr Type](#)
[cfMetricsKeyw Type](#)
[cfMetricsName Type](#)
[cfMLangString Type](#)
[cfOrgUnit Type](#)
[cfOrgUnit Class Type](#)
[cfOrgUnit DC Type](#)
[cfOrgUnit EAddr Type](#)
[cfOrgUnit Event Type](#)

[cfOrgUnit Fund Type](#)
[cfOrgUnit Indic Type](#)
[cfOrgUnit Meas Type](#)
[cfOrgUnit OrgUnit Type](#)
[cfOrgUnit PAddr Type](#)
[cfOrgUnit ResPubl Type](#)
[cfOrgUnitKeyw Type](#)
[cfOrgUnitName Type](#)
[cfOrgUnitResAct Type](#)
[cfPAddr Type](#)
[cfPAddr Class Type](#)
[cfPers Type](#)
[cfPers Class Type](#)
[cfPers Country Type](#)
[cfPers CV Type](#)
[cfPers DC Type](#)
[cfPers EAddr Type](#)
[cfPers Event Type](#)
[cfPers Fund Type](#)
[cfPers Indic Type](#)
[cfPers Lang Type](#)
[cfPers Meas Type](#)
[cfPers OrgUnit Type](#)
[cfPers PAddr Type](#)
[cfPers Pers Type](#)
[cfPers Qual Type](#)
[cfPers ResPubl Type](#)
[cfPersKeyw Type](#)
[cfPersName Type](#)
[cfPersName Pers Type](#)
[cfPersResInt Type](#)
[cfProj Type](#)
[cfProj Class Type](#)
[cfProj DC Type](#)
[cfProj Event Type](#)
[cfProj Fund Type](#)
[cfProj Indic Type](#)
[cfProj Meas Type](#)
[cfProj OrgUnit Type](#)
[cfProj Pers Type](#)
[cfProj Proj Type](#)
[cfProj ResPubl Type](#)
[cfProjAbstr Type](#)
[cfProjKeyw Type](#)
[cfProjTitle Type](#)
[cfQual Type](#)
[cfQual Class Type](#)
[cfQualDescr Type](#)
[cfQualKeyw Type](#)
[cfQualTitle Type](#)
[cfResPubl Type](#)
[cfResPubl Cite Type](#)

[cfResPubl Class Type](#)
[cfResPubl DC Type](#)
[cfResPubl Event Type](#)
[cfResPubl Fund Type](#)
[cfResPubl Indic Type](#)
[cfResPubl Meas Type](#)
[cfResPubl Metrics Type](#)
[cfResPubl ResPubl Type](#)
[cfResPublAbstr Type](#)
[cfResPublBiblNote Type](#)
[cfResPublKeyw Type](#)
[cfResPublNameAbbrev Type](#)
[cfResPublSubtitle Type](#)
[cfResPublTitle Type](#)
[cfResPublVersInfo Type](#)

element CERIF

<p>diagram</p>	<p>data</p> <ul style="list-style-type: none"> sourceDatabase ctClass ctClassScheme ctClassSchemeDescr ctLang ctLangName ctClassDescr ctClass_Class ctClassTerm ctClassScheme_ClassScheme ctCountry ctEvent ctEventName ctEventDescr ctEventKeyw ctEvent_Class ctEvent_Fund ctResPubl_Event ctFund ctFundName ctFundDescr ctFund_Class ctFundKeyw ctFund_Fund ctOrgint ctOrgintName ctOrgintResAct ctOrgintKeyw ctOrgint_Class ctOrgint_EAddr ctOrgint_Event ctOrgint_Fund ctOrgint_Orgint ctOrgint_ResPubl ctPers ctPersResInt ctPersKeyw ctPers_Pers ctPers_EAddr ctPers_Class ctPers_Event ctPers_Fund ctPers_Lang ctPers_Country ctPers_Orgint ctPers_ResPubl ctProj ctProj_Class ctProjTitle ctProjAbstr ctProjKeyw ctProj_Event ctProj_Fund ctProj_Orgint ctProj_Pers ctProj_Proj ctProj_ResPubl ctResPubl ctResPublTitle ctResPublAbstr ctResPubl_ResPubl ctResPubl_Class ctResPublKeyw ctEAddr ctEAddr ctOrgint_EAddr ctEAddr_Class ctPers_EAddr ctEAddr_Class ctResPubl_EAddr ctCurrency ctCurrencyName ctCurrencyExtName ctCountryName ctCountry_Class ctCurrency_Class ctLang_Class ctDC ctDCPublisher ctDCCreator ctDCContributor <p>sourceDatabase</p> <ul style="list-style-type: none"> ctDCRelation ctDCLanguage ctDCRightsHolder ctDCTitle ctDCSubject ctDCDescription ctDCDate ctDCAudience ctDCResourceType ctDCFormat ctDCResourceIdentifier ctDCProvenance ctDCSource ctDCCoverage ctDCCoverageSpatial ctDCCoverageTemporal ctDCRightsMM ctDCRightsMMAccessRights ctDCRightsMMLicense ctDCRightsMMPrivacy ctDCRightsMMRights ctDCRightsMMPricing ctDCRightsMMSecurity ctOrigint_DC ctPers_DC ctProj_DC ctQual ctPers_Qual ctQualDescr ctQual_Class ctResPubl_DC ctCite ctMetricx ctResPublMetricx ctEvent_Event ctResPublSubTitle ctResPubl_Cite ctCite_Class ctMetricx_Class ctResPubl_Metricx ctPersName ctPersName_Pers ctMetricName ctCiteTitle ctCiteDescr ctMetricDescr ctMetricKeyw ctMeas ctIndic ctIndic_Meas ctMeas_Class ctIndic_Class ctIndicName ctIndicDescr ctIndicKeyw ctMeasName ctMeasDescr ctMeasKeyw ctPers_Meas ctOrigint_Meas ctProj_Meas ctResPubl_Meas ctPers_Indic ctOrigint_Indic ctProj_Indic ctResPubl_Indic ctEvent_Meas ctEvent_Indic ctIndic_Indic ctMeas_Meas ctClassDef ctClassSchemeName ctClassEx ctFund_Indic ctFund_Meas ctQualTitle ctResPublVerbatim ctRedd ctRedd_Class
<p>namespace</p>	<p>urn.xmlns.org.eurocris.cerif-1.6-2</p>
<p>properties</p>	<p>content complex</p>

children	cfClass cfClassScheme cfClassSchemeDescr cfLang cfLangName cfClassDescr cfClass Class cfClassTerm cfClassScheme ClassScheme cfCountry cfEvent cfEventName cfEventDescr cfEventKeyw cfEvent Class cfEvent Fund cfResPubl Event cfFund cfFundName cfFundDescr cfFund Class cfFundKeyw cfFund Fund cfOrgUnit cfOrgUnitName cfOrgUnitResAct cfOrgUnitKeyw cfOrgUnit Class cfOrgUnit EAddr cfOrgUnit Event cfOrgUnit Fund cfOrgUnit OrgUnit cfOrgUnit ResPubl cfPers cfPersResInt cfPersKeyw cfPers Pers cfPers EAddr cfPers Class cfPers Event cfPers Fund cfPers Lang cfPers Country cfPers OrgUnit cfPers ResPubl cfProj cfProj Class cfProjTitle cfProjAbstr cfProjKeyw cfProj Event cfProj Fund cfProj OrgUnit cfProj Pers cfProj Proj cfProj ResPubl cfResPubl cfResPublTitle cfResPublAbstr cfResPubl ResPubl cfResPubl Class cfResPublKeyw cfEAddr cfPAddr cfOrgUnit PAddr cfEAddr Class cfPers PAddr cfPAddr Class cfResPubl Fund cfCurrency cfCurrencyName cfCurrencyEntName cfCountryName cfCountry Class cfCurrency Class cfLang Class cfEvent Event cfResPublSubtitle cfPersName cfPersName Pers cfClassSchemeName cfClassEx cfFedld cfFedld Class					
attributes	Name date sourceDatabase	Type xs:date xs:string	Use required required	Default	Fixed	annotation
source	<pre> <xs:element name="CERIF"> <xs:complexType> <xs:choice minOccurs="0" maxOccurs="unbounded"> <xs:annotation> <xs:documentation>Elementul de baza: permite aranjarea entitatilor si elementelor cerif in orice ordine.</xs:documentation> </xs:annotation> <xs:element name="cfClass" type="cfClass__Type"/> <xs:element name="cfClassScheme" type="cfClassScheme__Type"/> <xs:element name="cfClassSchemeDescr" type="cfClassSchemeDescr__Type"/> <xs:element name="cfLang" type="cfLang__Type"/> <xs:element name="cfLangName" type="cfLangName__Type"/> <xs:element name="cfClassDescr" type="cfClassDescr__Type"/> <xs:element name="cfClass_Class" type="cfClass_Class__Type"/> <xs:element name="cfClassTerm" type="cfClassTerm__Type"/> <xs:element name="cfClassScheme_ClassScheme" type="cfClassScheme_ClassScheme__Type"/> <xs:element name="cfCountry" type="cfCountry__Type"/> <xs:element name="cfCV" type="cfCV__Type"/> <xs:element name="cfEvent" type="cfEvent__Type"/> <xs:element name="cfEventName" type="cfEventName__Type"/> <xs:element name="cfEventDescr" type="cfEventDescr__Type"/> <xs:element name="cfEventKeyw" type="cfEventKeyw__Type"/> <xs:element name="cfEvent_Class" type="cfEvent_Class__Type"/> <xs:element name="cfEvent_Fund" type="cfEvent_Fund__Type"/> <xs:element name="cfResPubl_Event" type="cfResPubl_Event__Type"/> <xs:element name="cfFund" type="cfFund__Type"/> <xs:element name="cfFundName" type="cfFundName__Type"/> <xs:element name="cfFundDescr" type="cfFundDescr__Type"/> <xs:element name="cfFund_Class" type="cfFund_Class__Type"/> <xs:element name="cfFundKeyw" type="cfFundKeyw__Type"/> <xs:element name="cfFund_Fund" type="cfFund_Fund__Type"/> <xs:element name="cfOrgUnit" type="cfOrgUnit__Type"/> <xs:element name="cfOrgUnitName" type="cfOrgUnitName__Type"/> <xs:element name="cfOrgUnitResAct" type="cfOrgUnitResAct__Type"/> <xs:element name="cfOrgUnitKeyw" type="cfOrgUnitKeyw__Type"/> <xs:element name="cfOrgUnit_Class" type="cfOrgUnit_Class__Type"/> <xs:element name="cfOrgUnit_EAddr" type="cfOrgUnit_EAddr__Type"/> <xs:element name="cfOrgUnit_Event" type="cfOrgUnit_Event__Type"/> <xs:element name="cfOrgUnit_Fund" type="cfOrgUnit_Fund__Type"/> <xs:element name="cfOrgUnit_OrgUnit" type="cfOrgUnit_OrgUnit__Type"/> <xs:element name="cfOrgUnit_ResPubl" type="cfOrgUnit_ResPubl__Type"/> <xs:element name="cfPers" type="cfPers__Type"/> <xs:element name="cfPersResInt" type="cfPersResInt__Type"/> <xs:element name="cfPersKeyw" type="cfPersKeyw__Type"/> <xs:element name="cfPers_Pers" type="cfPers_Pers__Type"/> <xs:element name="cfPers_EAddr" type="cfPers_EAddr__Type"/> <xs:element name="cfPers_Class" type="cfPers_Class__Type"/> <xs:element name="cfPers_Event" type="cfPers_Event__Type"/> </pre>					

```

<xs:element name="cfPers_Fund" type="cfPers_Fund__Type"/>
<xs:element name="cfPers_Lang" type="cfPers_Lang__Type"/>
<xs:element name="cfPers_Country" type="cfPers_Country__Type"/>
<xs:element name="cfPers_OrgUnit" type="cfPers_OrgUnit__Type"/>
<xs:element name="cfPers_ResPubl" type="cfPers_ResPubl__Type"/>
<xs:element name="cfProj" type="cfProj__Type"/>
<xs:element name="cfProj_Class" type="cfProj_Class__Type"/>
<xs:element name="cfProjTitle" type="cfProjTitle__Type"/>
<xs:element name="cfProjAbstr" type="cfProjAbstr__Type"/>
<xs:element name="cfProjKeyw" type="cfProjKeyw__Type"/>
<xs:element name="cfProj_Event" type="cfProj_Event__Type"/>
<xs:element name="cfProj_Fund" type="cfProj_Fund__Type"/>
<xs:element name="cfProj_OrgUnit" type="cfProj_OrgUnit__Type"/>
<xs:element name="cfProj_Pers" type="cfProj_Pers__Type"/>
<xs:element name="cfProj_Proj" type="cfProj_Proj__Type"/>
<xs:element name="cfProj_ResPubl" type="cfProj_ResPubl__Type"/>
<xs:element name="cfResPubl" type="cfResPubl__Type"/>
<xs:element name="cfResPublTitle" type="cfResPublTitle__Type"/>
<xs:element name="cfResPublAbstr" type="cfResPublAbstr__Type"/>
<xs:element name="cfResPubl_ResPubl" type="cfResPubl_ResPubl__Type"/>
<xs:element name="cfResPubl_Class" type="cfResPubl_Class__Type"/>
<xs:element name="cfResPublKeyw" type="cfResPublKeyw__Type"/>
<xs:element name="cfEAddr" type="cfEAddr__Type"/>
<xs:element name="cfPAddr" type="cfPAddr__Type"/>
<xs:element name="cfOrgUnit_PAddr" type="cfOrgUnit_PAddr__Type"/>
<xs:element name="cfEAddr_Class" type="cfEAddr_Class__Type"/>
<xs:element name="cfPers_PAddr" type="cfPers_PAddr__Type"/>
<xs:element name="cfPAddr_Class" type="cfPAddr_Class__Type"/>
<xs:element name="cfResPubl_Fund" type="cfResPubl_Fund__Type"/>
<xs:element name="cfCurrency" type="cfCurrency__Type"/>
<xs:element name="cfCurrencyName" type="cfCurrencyName__Type"/>
<xs:element name="cfCurrencyEntName" type="cfCurrencyEntName__Type"/>
<xs:element name="cfCountryName" type="cfCountryName__Type"/>
<xs:element name="cfCountry_Class" type="cfCountry_Class__Type"/>
<xs:element name="cfCurrency_Class" type="cfCurrency_Class__Type"/>
<xs:element name="cfLang_Class" type="cfLang_Class__Type"/>
<xs:element name="cfDC" type="cfDC__Type"/>
<xs:element name="cfDCPublisher" type="cfDCPublisher__Type"/>
<xs:element name="cfDCCreator" type="cfDCCreator__Type"/>
<xs:element name="cfDCContributor" type="cfDCContributor__Type"/>
<xs:element name="cfDCRelation" type="cfDCRelation__Type"/>
<xs:element name="cfDCLanguage" type="cfDCLanguage__Type"/>
<xs:element name="cfDCRightsHolder" type="cfDCRightsHolder__Type"/>
<xs:element name="cfDCTitle" type="cfDCTitle__Type"/>
<xs:element name="cfDCSubject" type="cfDCSubject__Type"/>
<xs:element name="cfDCDescription" type="cfDCDescription__Type"/>
<xs:element name="cfDCDate" type="cfDCDate__Type"/>
<xs:element name="cfDCAudience" type="cfDCAudience__Type"/>
<xs:element name="cfDCResourceType" type="cfDCResourceType__Type"/>
<xs:element name="cfDCFormat" type="cfDCFormat__Type"/>
<xs:element name="cfDCResourceIdentifier" type="cfDCResourceIdentifier__Type"/>
<xs:element name="cfDCProvenance" type="cfDCProvenance__Type"/>
<xs:element name="cfDCSource" type="cfDCSource__Type"/>
<xs:element name="cfDCCoverage" type="cfDCCoverage__Type"/>
<xs:element name="cfDCCoverageSpatial" type="cfDCCoverageSpatial__Type"/>
<xs:element name="cfDCCoverageTemporal" type="cfDCCoverageTemporal__Type"/>
<xs:element name="cfDCRightsMM" type="cfDCRightsMM__Type"/>
<xs:element name="cfDCRightsMMAccessRights"
type="cfDCRightsMMAccessRights__Type"/>
<xs:element name="cfDCRightsMMLicense" type="cfDCRightsMMLicense__Type"/>
<xs:element name="cfFDCRightsMMPrivacy" type="cfFDCRightsMMPrivacy__Type"/>
<xs:element name="cfFDCRightsMMRights" type="cfFDCRightsMMRights__Type"/>

```

	<pre> <xs:element name="cfFDCRightsMM Pricing" type="cfFDCRightsMM Pricing__Type"/> <xs:element name="cfFDCRightsMM Security" type="cfFDCRightsMM Security__Type"/> <xs:element name="cfOrgUnit_DC" type="cfOrgUnit_DC__Type"/> <xs:element name="cfPers_DC" type="cfPers_DC__Type"/> <xs:element name="cfProj_DC" type="cfProj_DC__Type"/> <xs:element name="cfQual" type="cfQual__Type"/> <xs:element name="cfPers_Qual" type="cfPers_Qual__Type"/> <xs:element name="cfQualDescr" type="cfQualDescr__Type"/> <xs:element name="cfQualKeyw" type="cfQualKeyw__Type"/> <xs:element name="cfQual_Class" type="cfQual_Class__Type"/> <xs:element name="cfResPubl_DC" type="cfResPubl_DC__Type"/> <xs:element name="cfCite" type="cfCite__Type"/> <xs:element name="cfResPublBiblNote" type="cfResPublBiblNote__Type"/> <xs:element name="cfResPublNameAbbrev" type="cfResPublNameAbbrev__Type"/> <xs:element name="cfEvent_Event" type="cfEvent_Event__Type"/> <xs:element name="cfResPublSubtitle" type="cfResPublSubtitle__Type"/> <xs:element name="cfResPubl_Cite" type="cfResPubl_Cite__Type"/> <xs:element name="cfCite_Class" type="cfCite_Class__Type"/> <xs:element name="cfPersName" type="cfPersName__Type"/> <xs:element name="cfPersName_Pers" type="cfPersName_Pers__Type"/> <xs:element name="cfCiteTitle" type="cfCiteTitle__Type"/> <xs:element name="cfCiteDescr" type="cfCiteDescr__Type"/> <xs:element name="cfClassDef" type="cfClassDef__Type"/> <xs:element name="cfClassSchemeName" type="cfClassSchemeName__Type"/> <xs:element name="cfClassEx" type="cfClassEx__Type"/> <xs:element name="cfQualTitle" type="cfQualTitle__Type"/> <xs:element name="cfResPublVersInfo" type="cfResPublVersInfo__Type"/> <xs:element name="cfFedId" type="cfFedId__Type"/> <xs:element name="cfFedId_Class" type="cfFedId_Class__Type"/> </xs:choice> <xs:attribute name="date" type="xs:date" use="required"/> <xs:attribute name="sourceDatabase" type="xs:string" use="required"/> </xs:complexType> </xs:element> </pre>
--	---

attribute CERIF/@date

type	xs:date
properties	isRef 0 use required
source	<xs:attribute name="date" type="xs:date" use="required"/>

attribute CERIF/@sourceDatabase

type	xs:string
properties	isRef 0 use required
source	<xs:attribute name="sourceDatabase" type="xs:string" use="required"/>

element CERIF/cfClass

<p>diagram</p>	
<p>namespace</p>	<p>urn:xmlns:org:eurocris:cerif-1.6-2</p>
<p>type</p>	<p>cfClass_Type</p>
<p>properties</p>	<p>isRef 0 content complex</p>
<p>children</p>	<p>cfClassId cfClassSchemeld cfStartDate cfEndDate cfURI cfDescr cfDescrSrc cfTerm cfTermSrc cfRoleExpr cfRoleExprOpp cfDef cfDefSrc cfEx cfExSrc cfClass_Class cfFedId</p>
<p>source</p>	<p><xs:element name="cfClass" type="cfClass__Type"/></p>

element CERIF/cfClassScheme

<p>diagram</p>	
<p>namespace</p>	<p>urn:xmlns:org:eurocris:cerif-1.6-2</p>
<p>type</p>	<p>cfClassScheme_Type</p>
<p>properties</p>	<p>isRef 0 content complex</p>
<p>children</p>	<p>cfClassSchemeld cfURI cfDescr cfDescrSrc cfName cfNameSrc cfClassScheme_ClassScheme cfFedId cfClass</p>
<p>source</p>	<p><code><xs:element name="cfClassScheme" type="cfClassScheme__Type"/></code></p>

element CERIF/cfClassSchemeDescr

<p>diagram</p>	
<p>namespace</p>	<p>urn:xmlns:org:eurocris:cerif-1.6-2</p>
<p>type</p>	<p>cfClassSchemeDescr_Type</p>
<p>properties</p>	<p>isRef 0 content complex</p>
<p>children</p>	<p>cfClassSchemeld cfDescr cfDescrSrc</p>
<p>source</p>	<p><code><xs:element name="cfClassSchemeDescr" type="cfClassSchemeDescr__Type"/></code></p>

element CERIF/cfLang

diagram	
namespace	urn:xmlns:org:eurocris:cerif-1.6-2
type	cfLang_Type
properties	isRef 0 content complex
children	cfLangCode cfURI cfName cfPers_Lang cfLang_Class cfFedId
source	<code><xs:element name="cfLang" type="cfLang__Type"/></code>

element CERIF/cfLangName

diagram	
namespace	urn:xmlns:org:eurocris:cerif-1.6-2
type	cfLangName_Type
properties	isRef 0 content complex
children	cfLangCodeOfLangName cfName
source	<code><xs:element name="cfLangName" type="cfLangName__Type"/></code>

element CERIF/cfClassDescr

diagram	
namespace	urn:xmlns:org:eurocris:cerif-1.6-2
type	cfClassDescr_Type

properties	isRef 0 content complex
children	cfClassId cfClassSchemeld cfDescr cfDescrSrc
source	<xs:element name="cfClassDescr" type="cfClassDescr__Type"/>

element CERIF/cfClass_Class

diagram	
namespace	urn:xmlns:org:eurocris:cerif-1.6-2
type	cfClass_Class_Type
properties	isRef 0 content complex
children	cfClassId1 cfClassId2 cfClassSchemeld1 cfClassSchemeld2 cfClassId cfClassSchemeld cfStartDate cfEndDate cfFraction
source	<xs:element name="cfClass_Class" type="cfClass_Class__Type"/>

element CERIF/cfClassTerm

diagram	
namespace	urn:xmlns:org:eurocris:cerif-1.6-2
type	cfClassTerm_Type
properties	isRef 0 content complex
children	cfClassId cfClassSchemeld cfTerm cfTermSrc cfRoleExpr cfRoleExprOpp
source	<xs:element name="cfClassTerm" type="cfClassTerm__Type"/>

element CERIF/cfClassScheme_ClassScheme

diagram	
namespace	urn:xmlns:org:eurocris:cerif-1.6-2
type	cfClassScheme_ClassScheme_Type
properties	isRef 0 content complex
children	cfClassSchemed1 cfClassSchemed2 cfClassId cfClassSchemed cfStartDate cfEndDate cfFraction
source	<xs:element name="cfClassScheme_ClassScheme" type="cfClassScheme_ClassScheme__Type"/>

element CERIF/cfCountry

diagram	
namespace	urn:xmlns:org:eurocris:cerif-1.6-2
type	cfCountry_Type
properties	isRef 0 content complex
children	cfCountryCode cfURI cfName cfPers_Country cfCountry_Class cfFedId
source	<xs:element name="cfCountry" type="cfCountry__Type"/>

element CERIF/cfCV

<p>diagram</p>	<pre> classDiagram class cfCV__Type { cfCVId cfCVDoc cfURI cfPers_CV cfCV_Class cfFedId } class cfCV cfCV -- "0..∞" cfCV__Type </pre>
<p>namespace</p>	<p>urn:xmlns:org:eurocris:cerif-1.6-2</p>
<p>type</p>	<p>cfCV_Type</p>
<p>properties</p>	<p>isRef 0 content complex</p>
<p>children</p>	<p>cfCVId cfCVDoc cfURI cfPers_CV cfCV_Class cfFedId</p>
<p>source</p>	<p><code><xs:element name="cfCV" type="cfCV__Type"/></code></p>

element CERIF/cfEvent

<p>diagram</p>	
<p>namespace</p>	<p>urn:xmlns:org:eurocris:cerif-1.6-2</p>
<p>type</p>	<p>cfEvent__Type</p>
<p>properties</p>	<p>isRef 0 content complex</p>
<p>children</p>	<p>cfEventId cfCountryCode cfCityTown cfFeeOrFree cfStartDate cfEndDate cfURI cfName cfDescr cfKeyw cfEvent_Class cfEvent_Fund cfResPubl_Event cfOrgUnit_Event cfPers_Event cfProj_Event cfEvent_Event cfEvent_Meas cfEvent_Indic cfFedId</p>
<p>source</p>	<p><xs:element name="cfEvent" type="cfEvent__Type"/></p>

element CERIF/cfEventName

diagram	
namespace	urn:xmlns:org:eurocris:cerif-1.6-2
type	cfEventName__Type
properties	isRef 0 content complex
children	cfEventId cfName
source	<code><xs:element name="cfEventName" type="cfEventName__Type"/></code>

element CERIF/cfEventDescr

diagram	
namespace	urn:xmlns:org:eurocris:cerif-1.6-2
type	cfEventDescr__Type
properties	isRef 0 content complex
children	cfEventId cfDescr
source	<code><xs:element name="cfEventDescr" type="cfEventDescr__Type"/></code>

element CERIF/cfEventKeyw

diagram	
namespace	urn:xmlns:org:eurocris:cerif-1.6-2
type	cfEventKeyw__Type
properties	isRef 0 content complex
children	cfEventId cfKeyw
source	<code><xs:element name="cfEventKeyw" type="cfEventKeyw__Type"/></code>

element CERIF/cfEvent_Class

diagram	<p>The diagram shows the structure of the <code>cfEvent_Class</code> element. It is composed of several parts: <ul style="list-style-type: none"> <code>cfEventId</code> (required) <code>cfCoreClassWithFraction_Group</code> (required), which contains: <ul style="list-style-type: none"> <code>cfCoreClass_Group</code> (required), which contains: <ul style="list-style-type: none"> <code>cfClassId</code> (required) <code>cfClassSchemeld</code> (required) <code>cfStartDate</code> (optional) <code>cfEndDate</code> (optional) <code>cfFraction</code> (optional) </p>
namespace	urn.xmlns:org:eurocris:cerif-1.6-2
type	cfEvent_Class_Type
properties	isRef 0 content complex
children	cfEventId cfClassId cfClassSchemeld cfStartDate cfEndDate cfFraction
source	<code><xs:element name="cfEvent_Class" type="cfEvent_Class__Type"/></code>

element CERIF/cfEvent_Fund

diagram	<p>The diagram shows the structure of the <code>cfEvent_Fund</code> element. It is composed of several parts: <ul style="list-style-type: none"> <code>cfEventId</code> (required) <code>cfFundId</code> (required) <code>cfCoreClassWithFraction_Group</code> (required), which contains: <ul style="list-style-type: none"> <code>cfCoreClass_Group</code> (required), which contains: <ul style="list-style-type: none"> <code>cfClassId</code> (required) <code>cfClassSchemeld</code> (required) <code>cfStartDate</code> (optional) <code>cfEndDate</code> (optional) <code>cfFraction</code> (optional) <code>cfAmount</code> (optional) </p>
namespace	urn.xmlns:org:eurocris:cerif-1.6-2
type	cfEvent_Fund_Type
properties	isRef 0 content complex
children	cfEventId cfFundId cfClassId cfClassSchemeld cfStartDate cfEndDate cfFraction cfAmount
source	<code><xs:element name="cfEvent_Fund" type="cfEvent_Fund__Type"/></code>

element CERIF/cfResPubl_Event

<p>diagram</p>	<pre> classDiagram class cfResPubl_Event__Type { cfResPublId cfEventId cfCoreClassWithFraction_Group cfCoreClass_Group cfClassId cfClassSchemeId cfStartDate cfEndDate cfFraction } cfResPubl_Event__Type "1" -- "*" cfResPublId cfResPubl_Event__Type "1" -- "*" cfEventId cfResPubl_Event__Type "1" -- "*" cfCoreClassWithFraction_Group cfResPubl_Event__Type "1" -- "*" cfCoreClass_Group cfResPubl_Event__Type "1" -- "*" cfClassId cfResPubl_Event__Type "1" -- "*" cfClassSchemeId cfResPubl_Event__Type "1" -- "*" cfStartDate cfResPubl_Event__Type "1" -- "*" cfEndDate cfResPubl_Event__Type "1" -- "*" cfFraction </pre>
<p>namespace</p>	<p>urn:xmlns:org:eurocris:cerif-1.6-2</p>
<p>type</p>	<p>cfResPubl_Event_Type</p>
<p>properties</p>	<p>isRef 0 content complex</p>
<p>children</p>	<p>cfResPublId cfEventId cfClassId cfClassSchemeId cfStartDate cfEndDate cfFraction</p>
<p>source</p>	<p><xs:element name="cfResPubl_Event" type="cfResPubl_Event__Type"/></p>

element CERIF/cfFund

<p>diagram</p>	
<p>namespace</p>	<p>urn:xmlns:org:eurocris:cerif-1.6-2</p>
<p>type</p>	<p>cfFund__Type</p>
<p>properties</p>	<p>isRef 0 content complex</p>
<p>children</p>	<p>cfFundId cfStartDate cfEndDate cfAcro cfAmount cfURI cfName cfDescr cfKeyw cfEvent_Fund cfFund_Class cfFund_Fund cfOrgUnit_Fund cfPers_Fund cfProj_Fund cfResPubl_Fund cfFund_Indic cfFund_Meas cfFedId</p>
<p>source</p>	<p><xs:element name="cfFund" type="cfFund__Type"/></p>

element CERIF/cfFundName

diagram	
namespace	urn:xmlns:org:eurocris:cerif-1.6-2
type	cfFundName_Type
properties	isRef 0 content complex
children	cfFundId cfName
source	<code><xs:element name="cfFundName" type="cfFundName__Type"/></code>

element CERIF/cfFundDescr

diagram	
namespace	urn:xmlns:org:eurocris:cerif-1.6-2
type	cfFundDescr_Type
properties	isRef 0 content complex
children	cfFundId cfDescr
source	<code><xs:element name="cfFundDescr" type="cfFundDescr__Type"/></code>

element CERIF/cfFund_Class

diagram	
namespace	urn:xmlns:org:eurocris:cerif-1.6-2
type	cfFund_Class_Type
properties	isRef 0 content complex
children	cfFundId cfClassId cfClassSchemeld cfStartDate cfEndDate cfFraction
source	<code><xs:element name="cfFund_Class" type="cfFund_Class__Type"/></code>

element CERIF/cfFundKeyw

diagram	
namespace	urn:xmlns:org:eurocris:cerif-1.6-2
type	cfFundKeyw_Type
properties	isRef 0 content complex
children	cfFundId cfKeyw
source	<code><xs:element name="cfFundKeyw" type="cfFundKeyw__Type"/></code>

element CERIF/cfFund_Fund

diagram	
namespace	urn:xmlns:org:eurocris:cerif-1.6-2
type	cfFund_Fund_Type
properties	isRef 0 content complex
children	cfFundId1 cfFundId2 cfClassId cfClassSchemeId cfStartDate cfEndDate cfFraction
source	<code><xs:element name="cfFund_Fund" type="cfFund_Fund__Type"/></code>

element CERIF/cfOrgUnit

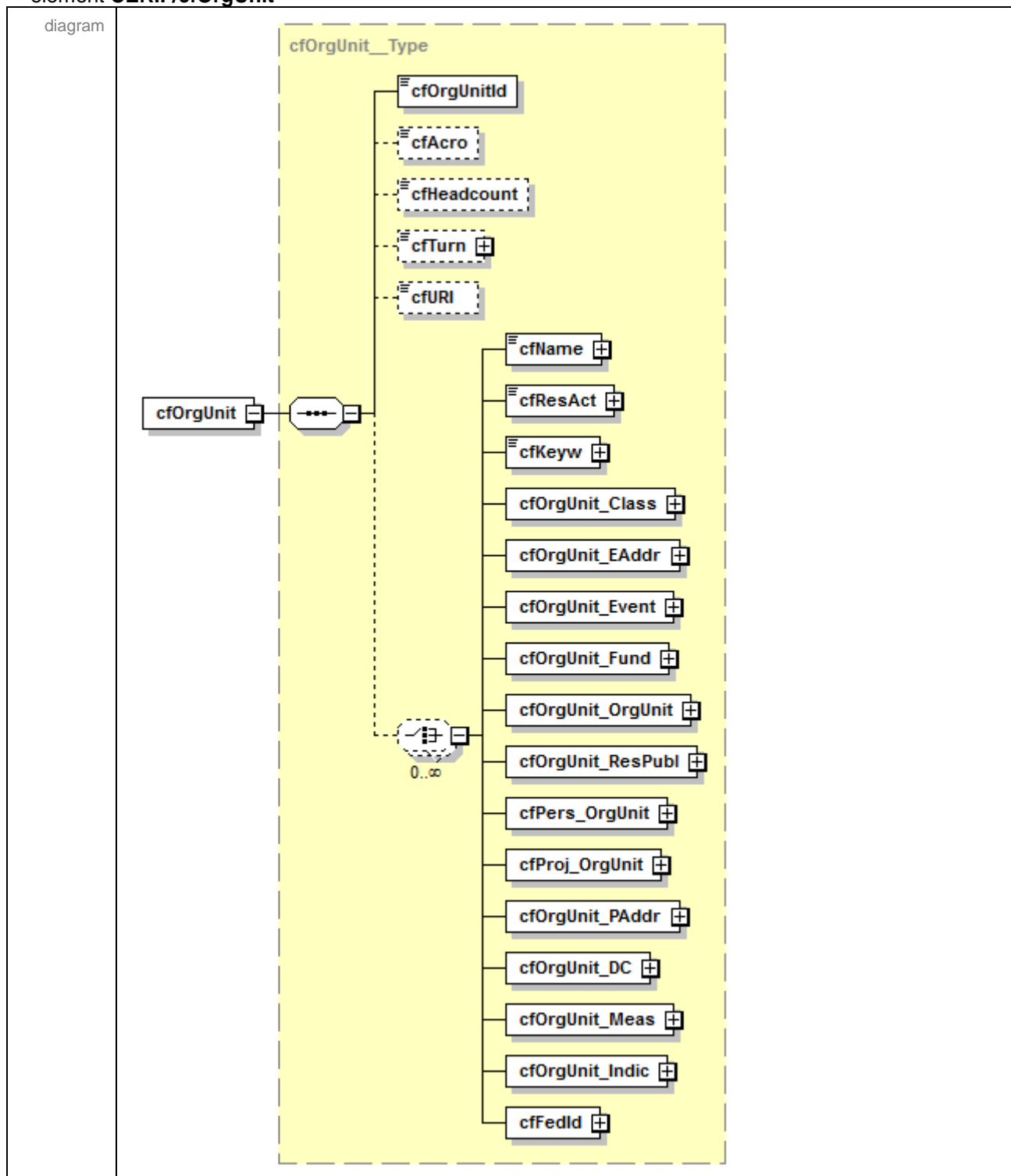

namespace	urn:xmlns:org:eurocris:cerif-1.6-2
type	cfOrgUnit_Type
properties	isRef 0 content complex
children	cfOrgUnitId cfAcro cfHeadcount cfTurn cfURI cfName cfResAct cfKeyw cfOrgUnit_Class cfOrgUnit_EAddr cfOrgUnit_Event cfOrgUnit_Fund cfOrgUnit_OrgUnit cfOrgUnit_ResPubl cfPers_OrgUnit cfProj_OrgUnit cfOrgUnit_PAddr cfOrgUnit_DC cfOrgUnit_Meas cfOrgUnit_Indic cfFedId
source	<code><xs:element name="cfOrgUnit" type="cfOrgUnit__Type"/></code>

element CERIF/cfOrgUnitName

diagram	
namespace	urn:xmlns:org:eurocris:cerif-1.6-2
type	cfOrgUnitName__Type
properties	isRef 0 content complex
children	cfOrgUnitId cfName
source	<code><xs:element name="cfOrgUnitName" type="cfOrgUnitName__Type"/></code>

element CERIF/cfOrgUnitResAct

diagram	
namespace	urn:xmlns:org:eurocris:cerif-1.6-2
type	cfOrgUnitResAct__Type
properties	isRef 0 content complex
children	cfOrgUnitId cfResAct
source	<code><xs:element name="cfOrgUnitResAct" type="cfOrgUnitResAct__Type"/></code>

element CERIF/cfOrgUnitKeyw

diagram	
namespace	urn:xmlns:org:eurocris:cerif-1.6-2
type	cfOrgUnitKeyw__Type
properties	isRef 0 content complex
children	cfOrgUnitId cfKeyw
source	<code><xs:element name="cfOrgUnitKeyw" type="cfOrgUnitKeyw__Type"/></code>

element CERIF/cfOrgUnit_Class

diagram	
namespace	urn:xmlns:org:eurocris:cerif-1.6-2
type	cfOrgUnit_Class_Type
properties	isRef 0 content complex
children	cfOrgUnitId cfClassId cfClassSchemeld cfStartDate cfEndDate cfFraction
source	<code><xs:element name="cfOrgUnit_Class" type="cfOrgUnit_Class_Type"/></code>

element CERIF/cfOrgUnit_EAddr

diagram	
namespace	urn:xmlns:org:eurocris:cerif-1.6-2
type	cfOrgUnit_EAddr_Type
properties	isRef 0 content complex
children	cfOrgUnitId cfEAddrId cfClassId cfClassSchemeld cfStartDate cfEndDate cfFraction
source	<code><xs:element name="cfOrgUnit_EAddr" type="cfOrgUnit_EAddr_Type"/></code>

element CERIF/cfOrgUnit_Event

diagram	
namespace	urn:xmlns:org:eurocris:cerif-1.6-2
type	cfOrgUnit_Event_Type
properties	isRef 0 content complex
children	cfOrgUnitId cfEventId cfClassId cfClassSchemeld cfStartDate cfEndDate cfFraction
source	<code><xs:element name="cfOrgUnit_Event" type="cfOrgUnit_Event__Type"/></code>

element CERIF/cfOrgUnit_Fund

diagram	
namespace	urn:xmlns:org:eurocris:cerif-1.6-2
type	cfOrgUnit_Fund_Type
properties	isRef 0 content complex
children	cfOrgUnitId cfFundId cfClassId cfClassSchemeld cfStartDate cfEndDate cfFraction cfAmount
source	<code><xs:element name="cfOrgUnit_Fund" type="cfOrgUnit_Fund__Type"/></code>

element CERIF/cfOrgUnit_OrgUnit

diagram	
namespace	urn:xmlns:org:eurocris:cerif-1.6-2
type	cfOrgUnit_OrgUnit_Type
properties	isRef 0 content complex
children	cfOrgUnitId1 cfOrgUnitId2 cfClassId cfClassSchemeId cfStartDate cfEndDate cfFraction
source	<code><xs:element name="cfOrgUnit_OrgUnit" type="cfOrgUnit_OrgUnit_Type"/></code>

element CERIF/cfOrgUnit_ResPubl

diagram	
namespace	urn:xmlns:org:eurocris:cerif-1.6-2
type	cfOrgUnit_ResPubl_Type
properties	isRef 0 content complex
children	cfOrgUnitId cfResPublId cfClassId cfClassSchemeId cfStartDate cfEndDate cfFraction cfCopyright cfOrder
source	<code><xs:element name="cfOrgUnit_ResPubl" type="cfOrgUnit_ResPubl_Type"/></code>

element CERIF/cfPers

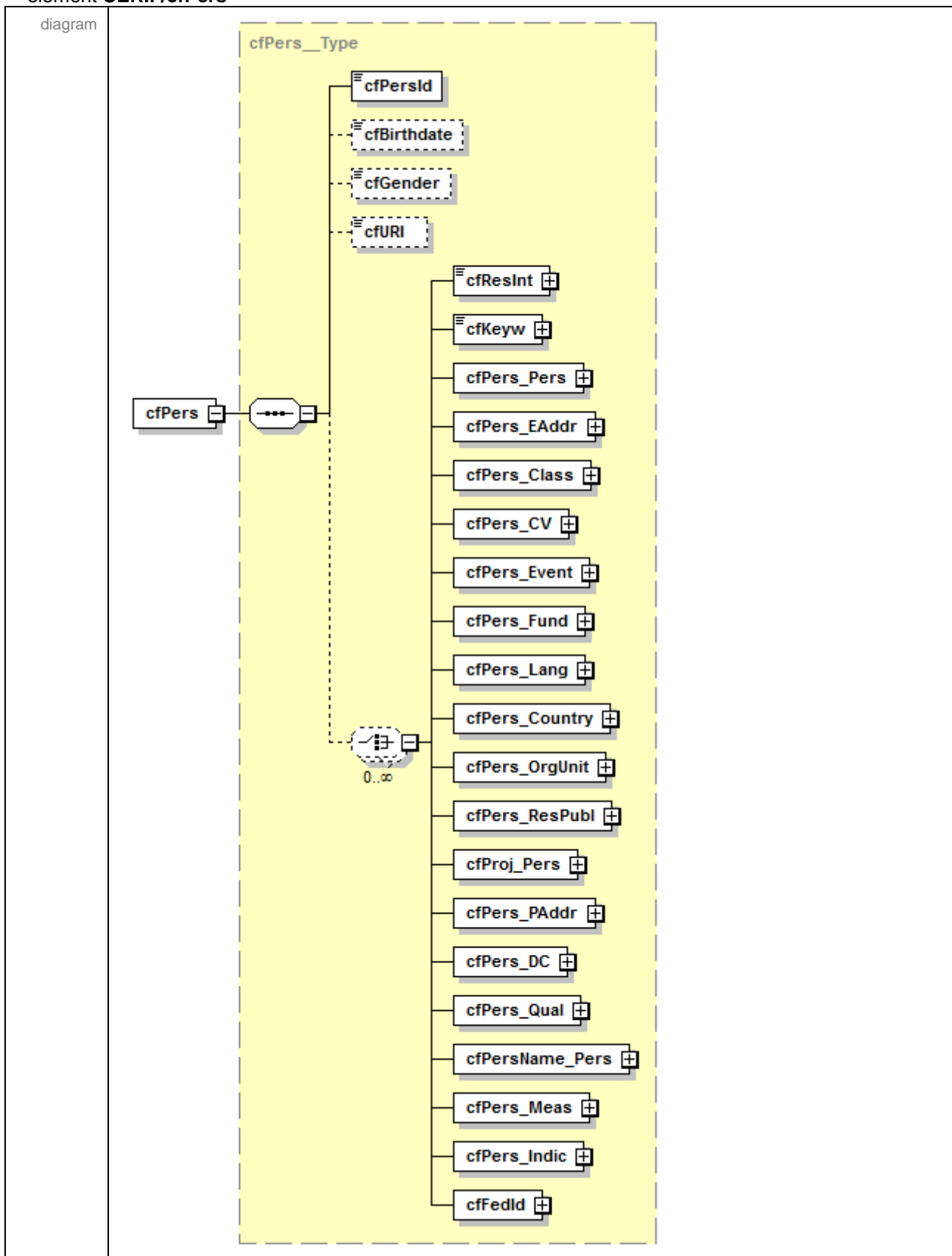

namespace	urn:xmlns:org:eurocris:cerif-1.6-2
type	cfPers_Type
properties	isRef 0 content complex
children	cfPersId cfBirthdate cfGender cfURI cfResInt cfKeyw cfPers_Pers cfPers_EAddr cfPers_Class cfPers_CV

	cfPers_Event cfPers_Fund cfPers_Lang cfPers_Country cfPers_OrqUnit cfPers_ResPubl cfProj_Pers cfPers_PAddr cfPers_DC cfPers_Qual cfPersName Pers cfPers_Meas cfPers_Indic cfFedId
source	<xs:element name="cfPers" type="cfPers__Type"/>

element CERIF/cfPersResInt

diagram	
namespace	urn:xmlns:org:eurocris:cerif-1.6-2
type	cfPersResInt_Type
properties	isRef 0 content complex
children	cfPersId cfResInt
source	<xs:element name="cfPersResInt" type="cfPersResInt__Type"/>

element CERIF/cfPersKeyw

diagram	
namespace	urn:xmlns:org:eurocris:cerif-1.6-2
type	cfPersKeyw_Type
properties	isRef 0 content complex
children	cfPersId cfKeyw
source	<xs:element name="cfPersKeyw" type="cfPersKeyw__Type"/>

element CERIF/cfPers_Pers

diagram	
namespace	urn:xmlns:org:eurocris:cerif-1.6-2
type	cfPers_Pers_Type
properties	isRef 0 content complex

children	cfPersId1 cfPersId2 cfClassId cfClassSchemeId cfStartDate cfEndDate cfFraction
source	<code><xs:element name="cfPers_Pers" type="cfPers_Pers__Type"/></code>

element CERIF/cfPers_EAddr

diagram	
namespace	urn.xmlns.org:eurocris:cerif-1.6-2
type	cfPers_EAddr_Type
properties	isRef 0 content complex
children	cfPersId cfEAddrId cfClassId cfClassSchemeId cfStartDate cfEndDate cfFraction
source	<code><xs:element name="cfPers_EAddr" type="cfPers_EAddr__Type"/></code>

element CERIF/cfPers_Class

diagram	
namespace	urn.xmlns.org:eurocris:cerif-1.6-2
type	cfPers_Class_Type
properties	isRef 0 content complex
children	cfPersId cfClassId cfClassSchemeId cfStartDate cfEndDate cfFraction
source	<code><xs:element name="cfPers_Class" type="cfPers_Class__Type"/></code>

element CERIF/cfPers_Event

diagram	
namespace	urn.xmlns:org:eurocris:cerif-1.6-2
type	cfPers_Event_Type
properties	isRef 0 content complex
children	cfPersId cfEventId cfClassId cfClassSchemeld cfStartDate cfEndDate cfFraction
source	<code><xs:element name="cfPers_Event" type="cfPers_Event__Type"/></code>

element CERIF/cfPers_Fund

diagram	
namespace	urn.xmlns:org:eurocris:cerif-1.6-2
type	cfPers_Fund_Type
properties	isRef 0 content complex
children	cfPersId cfFundId cfClassId cfClassSchemeld cfStartDate cfEndDate cfFraction cfAmount
source	<code><xs:element name="cfPers_Fund" type="cfPers_Fund__Type"/></code>

element CERIF/cfPers_Lang

<p>diagram</p>	
<p>namespace</p>	<p>urn.xmlns:org:eurocris:cerif-1.6-2</p>
<p>type</p>	<p>cfPers_Lang_Type</p>
<p>properties</p>	<p>isRef 0 content complex</p>
<p>children</p>	<p>cfPersId cfLangCode cfClassId cfClassSchemeld cfStartDate cfEndDate cfFraction cfSkillReading cfSkillSpeaking cfSkillWriting</p>
<p>source</p>	<p><code><xs:element name="cfPers_Lang" type="cfPers_Lang_Type"/></code></p>

element CERIF/cfPers_Country

<p>diagram</p>	
<p>namespace</p>	<p>urn.xmlns:org:eurocris:cerif-1.6-2</p>
<p>type</p>	<p>cfPers_Country_Type</p>
<p>properties</p>	<p>isRef 0 content complex</p>
<p>children</p>	<p>cfPersId cfCountryCode cfClassId cfClassSchemeld cfStartDate cfEndDate cfFraction</p>
<p>source</p>	<p><code><xs:element name="cfPers_Country" type="cfPers_Country_Type"/></code></p>

element CERIF/cfPers_OrgUnit

diagram	
namespace	urn:xmlns:org:eurocris:cerif-1.6-2
type	cfPers_OrgUnit_Type
properties	isRef 0 content complex
children	cfPersId cfOrgUnitId cfClassId cfClassSchemeld cfStartDate cfEndDate cfFraction
source	<xs:element name="cfPers_OrgUnit" type="cfPers_OrgUnit__Type"/>

element CERIF/cfPers_ResPubl

diagram	
namespace	urn:xmlns:org:eurocris:cerif-1.6-2
type	cfPers_ResPubl_Type
properties	isRef 0 content complex
children	cfPersId cfResPublId cfClassId cfClassSchemeld cfStartDate cfEndDate cfFraction cfCopyright cfOrder
source	<xs:element name="cfPers_ResPubl" type="cfPers_ResPubl__Type"/>

element CERIF/cfProj

<p>diagram</p>	
<p>namespace</p>	<p>urn:xmlns:org:eurocris:cerif-1.6-2</p>
<p>type</p>	<p>cfProj_Type</p>
<p>properties</p>	<p>isRef 0 content complex</p>
<p>children</p>	<p>cfProjId cfStartDate cfEndDate cfAcro cfURI cfTitle cfAbstr cfKeyw cfProj_Class cfProj_Event cfProj_Fund cfProj_OrgUnit cfProj_Pers cfProj_Proj cfProj_ResPubl cfProj_DC cfProj_Meas cfProj_Indic cfFedId</p>
<p>source</p>	<p><xs:element name="cfProj" type="cfProj_Type"/></p>

element CERIF/cfProj_Class

diagram	
namespace	urn:xmlns:org:eurocris:cerif-1.6-2
type	cfProj_Class_Type
properties	isRef 0 content complex
children	cfProjId cfClassId cfClassSchemeld cfStartDate cfEndDate cfFraction
source	<code><xs:element name="cfProj_Class" type="cfProj_Class__Type"/></code>

element CERIF/cfProjTitle

diagram	
namespace	urn:xmlns:org:eurocris:cerif-1.6-2
type	cfProjTitle_Type
properties	isRef 0 content complex
children	cfProjId cfTitle
source	<code><xs:element name="cfProjTitle" type="cfProjTitle__Type"/></code>

element CERIF/cfProjAbstr

diagram	
namespace	urn:xmlns:org:eurocris:cerif-1.6-2
type	cfProjAbstr_Type
properties	isRef 0 content complex
children	cfProjId cfAbstr
source	<code><xs:element name="cfProjAbstr" type="cfProjAbstr__Type"/></code>

element CERIF/cfProjKeyw

diagram	
namespace	urn.xmlns:org:eurocris:cerif-1.6-2
type	cfProjKeyw_Type
properties	isRef 0 content complex
children	cfProjId cfKeyw
source	<code><xs:element name="cfProjKeyw" type="cfProjKeyw__Type"/></code>

element CERIF/cfProj_Event

diagram	
namespace	urn.xmlns:org:eurocris:cerif-1.6-2
type	cfProj_Event_Type
properties	isRef 0 content complex
children	cfProjId cfEventId cfClassId cfClassSchemeld cfStartDate cfEndDate cfFraction
source	<code><xs:element name="cfProj_Event" type="cfProj_Event__Type"/></code>

element CERIF/cfProj_Fund

diagram	
namespace	urn.xmlns:org:eurocris:cerif-1.6-2
type	cfProj_Fund_Type

properties	isRef 0 content complex
children	cfProjId cfFundId cfClassId cfClassSchemeId cfStartDate cfEndDate cfFraction cfAmount
source	<xs:element name="cfProj_Fund" type="cfProj_Fund__Type"/>

element CERIF/cfProj_OrgUnit

diagram	
namespace	urn:xmlns:org:eurocris:cerif-1.6-2
type	cfProj_OrgUnit_Type
properties	isRef 0 content complex
children	cfProjId cfOrgUnitId cfClassId cfClassSchemeId cfStartDate cfEndDate cfFraction
source	<xs:element name="cfProj_OrgUnit" type="cfProj_OrgUnit__Type"/>

element CERIF/cfProj_Pers

diagram	
namespace	urn:xmlns:org:eurocris:cerif-1.6-2
type	cfProj_Pers_Type
properties	isRef 0 content complex
children	cfProjId cfPersId cfClassId cfClassSchemeId cfStartDate cfEndDate cfFraction
source	<xs:element name="cfProj_Pers" type="cfProj_Pers__Type"/>

element CERIF/cfProj_Proj

diagram	
namespace	urn:xmlns:org:eurocris:cerif-1.6-2
type	cfProj_Proj_Type
properties	isRef 0 content complex
children	cfProjId1 cfProjId2 cfClassId cfClassSchemeld cfStartDate cfEndDate cfFraction
source	<code><xs:element name="cfProj_Proj" type="cfProj_Proj_Type"/></code>

element CERIF/cfProj_ResPubl

diagram	
namespace	urn:xmlns:org:eurocris:cerif-1.6-2
type	cfProj_ResPubl_Type
properties	isRef 0 content complex
children	cfProjId cfResPublId cfClassId cfClassSchemeld cfStartDate cfEndDate cfFraction cfCopyright
source	<code><xs:element name="cfProj_ResPubl" type="cfProj_ResPubl_Type"/></code>

element CERIF/cfResPubl

<p>diagram</p>	
<p>namespace</p>	<p>urn:xmlns:org:eurocris:cerif-1.6-2</p>
<p>type</p>	<p>cfResPubl_Type</p>
<p>properties</p>	<p>isRef 0 content complex</p>
<p>children</p>	<p>cfResPublId cfResPublDate cfNum cfVol cfEdition cfSeries cfIssue cfStartPage cfEndPage cfTotalPages cfISBN cfISSN cfURI cfTitle cfAbstr cfKeyw cfBiblNote cfNameAbbrev cfSubtitle cfVersInfo cfResPubl_Event cfOrgUnit_ResPubl cfPers_ResPubl cfProj_ResPubl cfResPubl_ResPubl cfResPubl_Class cfResPubl_Fund cfResPubl_DC cfResPubl_Cite cfResPubl_Metrics cfResPubl_Meas cfResPubl_Indic cfFedId</p>

	cfOrgUnit ResPubl cfPers ResPubl cfProi ResPubl cfResPubl ResPubl cfResPubl Class cfResPubl Fund cfResPubl DC cfResPubl Cite cfResPubl Metrics cfResPubl Meas cfResPubl Indic cfFedId
source	<xs:element name="cfResPubl" type="cfResPubl__Type"/>

element CERIF/cfResPublTitle

diagram	
namespace	urn:xmlns:org:eurocris:cerif-1.6-2
type	cfResPublTitle_Type
properties	isRef 0 content complex
children	cfResPublId cfTitle
source	<xs:element name="cfResPublTitle" type="cfResPublTitle__Type"/>

element CERIF/cfResPublAbstr

diagram	
namespace	urn:xmlns:org:eurocris:cerif-1.6-2
type	cfResPublAbstr_Type
properties	isRef 0 content complex
children	cfResPublId cfAbstr
source	<xs:element name="cfResPublAbstr" type="cfResPublAbstr__Type"/>

element CERIF/cfResPubl_ResPubl

diagram	
namespace	urn:xmlns:org:eurocris:cerif-1.6-2
type	cfResPubl_ResPubl_Type

properties	isRef 0 content complex
children	cfResPublId1 cfResPublId2 cfClassId cfClassSchemeld cfStartDate cfEndDate cfFraction
source	<code><xs:element name="cfResPubl_ResPubl" type="cfResPubl_ResPubl__Type"/></code>

element CERIF/cfResPubl_Class

diagram	
namespace	urn:xmlns:org:eurocris:cerif-1.6-2
type	cfResPubl_Class_Type
properties	isRef 0 content complex
children	cfResPublId cfClassId cfClassSchemeld cfStartDate cfEndDate cfFraction
source	<code><xs:element name="cfResPubl_Class" type="cfResPubl_Class__Type"/></code>

element CERIF/cfResPublKeyw

diagram	
namespace	urn:xmlns:org:eurocris:cerif-1.6-2
type	cfResPublKeyw_Type
properties	isRef 0 content complex
children	cfResPublId cfKeyw
source	<code><xs:element name="cfResPublKeyw" type="cfResPublKeyw__Type"/></code>

element CERIF/cfEAddr

<p>diagram</p>	
<p>namespace</p>	<p>urn:xmlns:org:eurocris:cerif-1.6-2</p>
<p>type</p>	<p>cfEAddr_Type</p>
<p>properties</p>	<p>isRef 0 content complex</p>
<p>children</p>	<p>cfEAddrId cfPAddrId cfURI cfOrgUnit_EAddr cfPers_EAddr cfEAddr_Class cfFedId</p>
<p>source</p>	<p><xs:element name="cfEAddr" type="cfEAddr__Type"/></p>

element CERIF/cfPAddr

<p>diagram</p>	
<p>namespace</p>	<p>urn:xmlns:org:eurocris:cerif-1.6-2</p>
<p>type</p>	<p>cfPAddr_Type</p>
<p>properties</p>	<p>isRef 0 content complex</p>
<p>children</p>	<p>cfPAddrId cfCountryCode cfAddrline1 cfAddrline2 cfAddrline3 cfAddrline4 cfAddrline5 cfPostCode cfCityTown cfStateOfCountry cfURI cfOrgUnit_PAddr cfPers_PAddr cfPAddr_Class cfFedId</p>
<p>source</p>	<p><xs:element name="cfPAddr" type="cfPAddr_Type"/></p>

element CERIF/cfOrgUnit_PAddr

<p>diagram</p>	
----------------	--

namespace	urn:xmlns:org:eurocris:cerif-1.6-2
type	cfOrgUnit_PAddr_Type
properties	isRef 0 content complex
children	cfOrgUnitId cfPAddrId cfClassId cfClassSchemeld cfStartDate cfEndDate cfFraction
source	<code><xs:element name="cfOrgUnit_PAddr" type="cfOrgUnit_PAddr__Type"/></code>

element CERIF/cfEAddr_Class

diagram	
namespace	urn:xmlns:org:eurocris:cerif-1.6-2
type	cfEAddr_Class_Type
properties	isRef 0 content complex
children	cfEAddrId cfClassId cfClassSchemeld cfStartDate cfEndDate cfFraction
source	<code><xs:element name="cfEAddr_Class" type="cfEAddr_Class__Type"/></code>

element CERIF/cfPers_PAddr

diagram	
namespace	urn:xmlns:org:eurocris:cerif-1.6-2
type	cfPers_PAddr_Type
properties	isRef 0 content complex
children	cfPersId cfPAddrId cfClassId cfClassSchemeld cfStartDate cfEndDate cfFraction
source	<code><xs:element name="cfPers_PAddr" type="cfPers_PAddr__Type"/></code>

element CERIF/cfPAddr_Class

diagram	
namespace	urn:xmlns:org:eurocris:cerif-1.6-2
type	cfPAddr_Class_Type
properties	isRef 0 content complex
children	cfPAddrId cfClassId cfClassSchemeId cfStartDate cfEndDate cfFraction
source	<code><xs:element name="cfPAddr_Class" type="cfPAddr_Class__Type"/></code>

element CERIF/cfResPubl_Fund

diagram	
namespace	urn:xmlns:org:eurocris:cerif-1.6-2
type	cfResPubl_Fund_Type
properties	isRef 0 content complex
children	cfResPublId cfFundId cfClassId cfClassSchemeId cfStartDate cfEndDate cfFraction cfAmount
source	<code><xs:element name="cfResPubl_Fund" type="cfResPubl_Fund__Type"/></code>

element CERIF/cfCurrency

diagram	
namespace	urn:xmlns:org:eurocris:cerif-1.6-2
type	cfCurrency_Type
properties	isRef 0 content complex
children	cfCurrCode cfNumCurrCode cfURI cfName cfEntName cfCurrency_Class cfFedId
source	<code><xs:element name="cfCurrency" type="cfCurrency__Type"/></code>

element CERIF/cfCurrencyName

diagram	
namespace	urn:xmlns:org:eurocris:cerif-1.6-2
type	cfCurrencyName_Type
properties	isRef 0 content complex
children	cfCurrCode cfName
source	<code><xs:element name="cfCurrencyName" type="cfCurrencyName__Type"/></code>

element CERIF/cfCurrencyEntName

diagram	
namespace	urn:xmlns:org:eurocris:cerif-1.6-2
type	cfCurrencyEntName_Type

properties	isRef 0 content complex
children	cfCurrCode cfEntName
source	<code><xs:element name="cfCurrencyEntName" type="cfCurrencyEntName__Type"/></code>

element CERIF/cfCountryName

diagram	
namespace	urn:xmlns:org:eurocris:cerif-1.6-2
type	cfCountryName__Type
properties	isRef 0 content complex
children	cfCountryCode cfName
source	<code><xs:element name="cfCountryName" type="cfCountryName__Type"/></code>

element CERIF/cfCountry_Class

diagram	
namespace	urn:xmlns:org:eurocris:cerif-1.6-2
type	cfCountry_Class__Type
properties	isRef 0 content complex
children	cfCountryCode cfClassId cfClassSchemeld cfStartDate cfEndDate cfFraction
source	<code><xs:element name="cfCountry_Class" type="cfCountry_Class__Type"/></code>

element CERIF/cfCurrency_Class

diagram	
namespace	urn:xmlns:org:eurocris:cerif-1.6-2
type	cfCurrency_Class_Type
properties	isRef 0 content complex
children	cfCurrCode cfClassId cfClassSchemeld cfStartDate cfEndDate cfFraction
source	<code><xs:element name="cfCurrency_Class" type="cfCurrency_Class_Type"/></code>

element CERIF/cfLang_Class

diagram	
namespace	urn:xmlns:org:eurocris:cerif-1.6-2
type	cfLang_Class_Type
properties	isRef 0 content complex
children	cfLangCode cfClassId cfClassSchemeld cfStartDate cfEndDate cfFraction
source	<code><xs:element name="cfLang_Class" type="cfLang_Class_Type"/></code>

element CERIF/cfDC

<p>diagram</p>	
<p>namespace</p>	<p>urn:xmlns:org:eurocris:cerif-1.6-2</p>
<p>type</p>	<p>cfDC_Type</p>
<p>properties</p>	<p>isRef 0 content complex</p>
<p>children</p>	<p>cfDCId cfDCScheme cfDCSchemeURI cfOrgUnit_DC cfPers_DC cfProj_DC cfResPubl_DC cfFedId</p>
<p>source</p>	<p><xs:element name="cfDC" type="cfDC_Type"/></p>

element CERIF/cfDCPublisher

<p>diagram</p>	
<p>namespace</p>	<p>urn:xmlns:org:eurocris:cerif-1.6-2</p>
<p>type</p>	<p>cfDCPublisher_Type</p>
<p>properties</p>	<p>isRef 0 content complex</p>
<p>children</p>	<p>cfDCId cfDCScheme cfDCLangTag cfDCTrans cfDCType cfDCValue</p>
<p>source</p>	<p><xs:element name="cfDCPublisher" type="cfDCPublisher_Type"/></p>

element CERIF/cfDCCreator

<p>diagram</p>	
<p>namespace</p>	<p>urn:xmlns:org:eurocris:cerif-1.6-2</p>
<p>type</p>	<p>cfDCCreator__Type</p>
<p>properties</p>	<p>isRef 0 content complex</p>
<p>children</p>	<p>cfDCId cfDCScheme cfDCLangTag cfDCTrans cfDCType cfDCValue</p>
<p>source</p>	<p><code><xs:element name="cfDCCreator" type="cfDCCreator__Type"/></code></p>

element CERIF/cfDCContributor

<p>diagram</p>	
<p>namespace</p>	<p>urn:xmlns:org:eurocris:cerif-1.6-2</p>
<p>type</p>	<p>cfDCContributor__Type</p>
<p>properties</p>	<p>isRef 0 content complex</p>
<p>children</p>	<p>cfDCId cfDCScheme cfDCLangTag cfDCTrans cfDCType cfDCValue</p>
<p>source</p>	<p><code><xs:element name="cfDCContributor" type="cfDCContributor__Type"/></code></p>

element CERIF/cfDCRelation

<p>diagram</p>	
<p>namespace</p>	<p>urn:xmlns:org:eurocris:cerif-1.6-2</p>
<p>type</p>	<p>cfDCRelation__Type</p>
<p>properties</p>	<p>isRef 0 content complex</p>
<p>children</p>	<p>cfDCId1 cfDCId2 cfDCScheme1 cfDCScheme2 cfDCLangTag cfDCTrans cfDCStartDate cfDCEndDate cfDCType cfDCValue</p>
<p>source</p>	<p><xs:element name="cfDCRelation" type="cfDCRelation__Type"/></p>

element CERIF/cfDCLanguage

<p>diagram</p>	
<p>namespace</p>	<p>urn:xmlns:org:eurocris:cerif-1.6-2</p>
<p>type</p>	<p>cfDCLanguage__Type</p>
<p>properties</p>	<p>isRef 0 content complex</p>
<p>children</p>	<p>cfDCId cfDCScheme cfDCLangTag cfDCTrans cfDCType cfDCValue</p>
<p>source</p>	<p><xs:element name="cfDCLanguage" type="cfDCLanguage__Type"/></p>

element CERIF/cfDCRightsHolder

<p>diagram</p>	<p>The diagram illustrates the structure of the <code>cfDCRightsHolder</code> element. It is a complex type containing the following children: <code>cfDCId</code>, <code>cfDCScheme</code>, <code>cfDCLangTag</code>, <code>cfDCTrans</code>, <code>cfDCType</code>, and <code>cfDCValue</code>. The children <code>cfDCType</code> and <code>cfDCValue</code> are shown as dashed boxes, indicating they are optional or derived types.</p>
<p>namespace</p>	<p>urn:xmlns:org:eurocris:cerif-1.6-2</p>
<p>type</p>	<p>cfDCRightsHolder_Type</p>
<p>properties</p>	<p>isRef 0 content complex</p>
<p>children</p>	<p>cfDCId cfDCScheme cfDCLangTag cfDCTrans cfDCType cfDCValue</p>
<p>source</p>	<p><code><xs:element name="cfDCRightsHolder" type="cfDCRightsHolder_Type"/></code></p>

element CERIF/cfDCTitle

<p>diagram</p>	<p>The diagram illustrates the structure of the <code>cfDCTitle</code> element. It is a complex type containing the following children: <code>cfDCId</code>, <code>cfDCScheme</code>, <code>cfDCLangTag</code>, <code>cfDCTrans</code>, <code>cfDCType</code>, and <code>cfDCValue</code>. The children <code>cfDCType</code> and <code>cfDCValue</code> are shown as dashed boxes, indicating they are optional or derived types.</p>
<p>namespace</p>	<p>urn:xmlns:org:eurocris:cerif-1.6-2</p>
<p>type</p>	<p>cfDCTitle_Type</p>
<p>properties</p>	<p>isRef 0 content complex</p>
<p>children</p>	<p>cfDCId cfDCScheme cfDCLangTag cfDCTrans cfDCType cfDCValue</p>
<p>source</p>	<p><code><xs:element name="cfDCTitle" type="cfDCTitle_Type"/></code></p>

element CERIF/cfDCSubject

diagram	
namespace	urn:xmlns:org:eurocris:cerif-1.6-2
type	cfDCSubject_Type
properties	isRef 0 content complex
children	cfDCId cfDCScheme cfDCLangTag cfDCTrans cfDCType cfDCValue
source	<code><xs:element name="cfDCSubject" type="cfDCSubject__Type"/></code>

element CERIF/cfDCDescription

diagram	
namespace	urn:xmlns:org:eurocris:cerif-1.6-2
type	cfDCDescription_Type
properties	isRef 0 content complex
children	cfDCId cfDCScheme cfDCLangTag cfDCTrans cfDCType cfDCValue
source	<code><xs:element name="cfDCDescription" type="cfDCDescription__Type"/></code>

element CERIF/cfDCDate

<p>diagram</p>	
<p>namespace</p>	<p>urn:xmlns:org:eurocris:cerif-1.6-2</p>
<p>type</p>	<p>cfDCDate_Type</p>
<p>properties</p>	<p>isRef 0 content complex</p>
<p>children</p>	<p>cfDCId cfDCScheme cfDCLangTag cfDCTrans cfDCType cfDCValue cfDCDateBegin cfDCDateEnd</p>
<p>source</p>	<p><code><xs:element name="cfDCDate" type="cfDCDate__Type"/></code></p>

element CERIF/cfDCAudience

<p>diagram</p>	
<p>namespace</p>	<p>urn:xmlns:org:eurocris:cerif-1.6-2</p>
<p>type</p>	<p>cfDCAudience_Type</p>
<p>properties</p>	<p>isRef 0 content complex</p>
<p>children</p>	<p>cfDCId cfDCScheme cfDCLangTag cfDCTrans cfDCType cfDCValue</p>
<p>source</p>	<p><code><xs:element name="cfDCAudience" type="cfDCAudience__Type"/></code></p>

element CERIF/cfDCResourceType

diagram	
namespace	urn:xmlns:org:eurocris:cerif-1.6-2
type	cfDCResourceType__Type
properties	isRef 0 content complex
children	cfDCId cfDCScheme cfDCLangTag cfDCTrans cfDCType cfDCValue
source	<code><xs:element name="cfDCResourceType" type="cfDCResourceType__Type"/></code>

element CERIF/cfDCFormat

diagram	
namespace	urn:xmlns:org:eurocris:cerif-1.6-2
type	cfDCFormat__Type
properties	isRef 0 content complex
children	cfDCId cfDCScheme cfDCLangTag cfDCTrans cfDCType cfDCValue
source	<code><xs:element name="cfDCFormat" type="cfDCFormat__Type"/></code>

element CERIF/cfDCResourceIdentifier

<p>diagram</p>	<p>The diagram illustrates the structure of the <code>cfDCResourceIdentifier</code> element. It is a complex type containing the following children: <code>cfDCId</code>, <code>cfDCScheme</code>, <code>cfDCLangTag</code>, <code>cfDCTrans</code>, <code>cfDCType</code>, and <code>cfDCValue</code>. The children <code>cfDCType</code> and <code>cfDCValue</code> are shown as dashed boxes, indicating they are optional or derived. The entire structure is enclosed in a dashed box labeled <code>cfDCResourceIdentifier__Type</code>.</p>
<p>namespace</p>	<p>urn:xmlns:org:eurocris:cerif-1.6-2</p>
<p>type</p>	<p>cfDCResourceIdentifier__Type</p>
<p>properties</p>	<p>isRef 0 content complex</p>
<p>children</p>	<p>cfDCId cfDCScheme cfDCLangTag cfDCTrans cfDCType cfDCValue</p>
<p>source</p>	<p><code><xs:element name="cfDCResourceIdentifier" type="cfDCResourceIdentifier__Type"/></code></p>

element CERIF/cfDCProvenance

<p>diagram</p>	<p>The diagram illustrates the structure of the <code>cfDCProvenance</code> element. It is a complex type containing the following children: <code>cfDCId</code>, <code>cfDCScheme</code>, <code>cfDCLangTag</code>, <code>cfDCTrans</code>, <code>cfDCType</code>, and <code>cfDCValue</code>. The children <code>cfDCType</code> and <code>cfDCValue</code> are shown as dashed boxes, indicating they are optional or derived. The entire structure is enclosed in a dashed box labeled <code>cfDCProvenance__Type</code>.</p>
<p>namespace</p>	<p>urn:xmlns:org:eurocris:cerif-1.6-2</p>
<p>type</p>	<p>cfDCProvenance__Type</p>
<p>properties</p>	<p>isRef 0 content complex</p>
<p>children</p>	<p>cfDCId cfDCScheme cfDCLangTag cfDCTrans cfDCType cfDCValue</p>
<p>source</p>	<p><code><xs:element name="cfDCProvenance" type="cfDCProvenance__Type"/></code></p>

element CERIF/cfDCSource

<p>diagram</p>	
<p>namespace</p>	<p>urn:xmlns:org:eurocris:cerif-1.6-2</p>
<p>type</p>	<p>cfDCSource_Type</p>
<p>properties</p>	<p>isRef 0 content complex</p>
<p>children</p>	<p>cfDCId cfDCScheme cfDCLangTag cfDCTrans cfDCType cfDCValue</p>
<p>source</p>	<p><code><xs:element name="cfDCSource" type="cfDCSource__Type"/></code></p>

element CERIF/cfDCCoverage

<p>diagram</p>	
<p>namespace</p>	<p>urn:xmlns:org:eurocris:cerif-1.6-2</p>
<p>type</p>	<p>cfDCCoverage_Type</p>
<p>properties</p>	<p>isRef 0 content complex</p>
<p>children</p>	<p>cfDCId cfDCScheme cfDCTrans cfDCLangTag cfDCType cfDCValue</p>
<p>source</p>	<p><code><xs:element name="cfDCCoverage" type="cfDCCoverage__Type"/></code></p>

element CERIF/cfDCCoverageSpatial

<p>diagram</p>	
<p>namespace</p>	<p>urn:xmlns:org:eurocris:cerif-1.6-2</p>
<p>type</p>	<p>cfDCCoverageSpatial__Type</p>
<p>properties</p>	<p>isRef 0 content complex</p>
<p>children</p>	<p>cfDCId cfDCScheme cfDCLangTag cfDCTrans cfDCValue cfDCCXCoordinate cfDCCYCoordinate cfDCCZCoordinate cfDCPrecision</p>
<p>source</p>	<p><xs:element name="cfDCCoverageSpatial" type="cfDCCoverageSpatial__Type"/></p>

element CERIF/cfDCCoverageTemporal

<p>diagram</p>	
<p>namespace</p>	<p>urn:xmlns:org:eurocris:cerif-1.6-2</p>
<p>type</p>	<p>cfDCCoverageTemporal__Type</p>
<p>properties</p>	<p>isRef 0 content complex</p>
<p>children</p>	<p>cfDCId cfDCScheme cfDCLangTag cfDCTrans cfDCValue cfDCStartTime cfDCEndTime cfDCPrecision</p>

	cfDCPrecision
source	<code><xs:element name="cfDCCoverageTemporal" type="cfDCCoverageTemporal__Type"/></code>

element CERIF/cfDCRightsMM

diagram	
namespace	urn:xmlns:org:eurocris:cerif-1.6-2
type	cfDCRightsMM_Type
properties	isRef 0 content complex
children	cfDCId cfDCScheme cfDCLangTag cfDCTrans cfDCValue cfDCType
source	<code><xs:element name="cfDCRightsMM" type="cfDCRightsMM__Type"/></code>

element CERIF/cfDCRightsMMAccessRights

diagram	
namespace	urn:xmlns:org:eurocris:cerif-1.6-2
type	cfDCRightsMMAccessRights_Type
properties	isRef 0 content complex
children	cfDCId cfDCScheme cfDCLangTag cfDCTrans cfDCValue
source	<code><xs:element name="cfDCRightsMMAccessRights" type="cfDCRightsMMAccessRights__Type"/></code>

element CERIF/cfDCRightsMMLicense

diagram	
namespace	urn:xmlns:org:eurocris:cerif-1.6-2
type	cfDCRightsMMLicense_Type
properties	isRef 0 content complex
children	cfDCId cfDCScheme cfDCLangTag cfDCTrans cfDCValue
source	<code><xs:element name="cfDCRightsMMLicense" type="cfDCRightsMMLicense__Type"/></code>

element CERIF/cfFDCRightsMMPrivacy

diagram	
namespace	urn:xmlns:org:eurocris:cerif-1.6-2
type	cfFDCRightsMMPrivacy_Type
properties	isRef 0 content complex
children	cfDCId cfDCScheme cfDCLangTag cfDCTrans cfFDCPrivacyConstraint
source	<code><xs:element name="cfFDCRightsMMPrivacy" type="cfFDCRightsMMPrivacy__Type"/></code>

element CERIF/cfDCRightsMMRights

diagram	
namespace	urn.xmlns.org:eurocris:cerif-1.6-2
type	cfDCRightsMMRights__Type
properties	isRef 0 content complex
children	cfDCId cfDCScheme cfDCLangTag cfDCTrans cfDCRightsConstraint
source	<code><xs:element name="cfDCRightsMMRights" type="cfDCRightsMMRights__Type"/></code>

element CERIF/cfDCRightsMMPricing

diagram	
namespace	urn.xmlns.org:eurocris:cerif-1.6-2
type	cfDCRightsMMPricing__Type
properties	isRef 0 content complex
children	cfDCId cfDCScheme cfDCLangTag cfDCTrans cfDCPriceConstraint
source	<code><xs:element name="cfDCRightsMMPricing" type="cfDCRightsMMPricing__Type"/></code>

element CERIF/cfFDCRightsMMSecurity

diagram	
namespace	urn:xmlns:org:eurocris:cerif-1.6-2
type	cfFDCRightsMMSecurity__Type
properties	isRef 0 content complex
children	cfDCId cfDCScheme cfDCLangTag cfDCTrans cfFDCSecurityConstraint
source	<code><xs:element name="cfFDCRightsMMSecurity" type="cfFDCRightsMMSecurity__Type"/></code>

element CERIF/cfOrgUnit_DC

diagram	
namespace	urn:xmlns:org:eurocris:cerif-1.6-2
type	cfOrgUnit_DC__Type
properties	isRef 0 content complex
children	cfOrgUnitId cfDCId cfDCScheme cfClassId cfClassSchemeId cfStartDate cfEndDate cfFraction
source	<code><xs:element name="cfOrgUnit_DC" type="cfOrgUnit_DC__Type"/></code>

element CERIF/cfPers_DC

<p>diagram</p>	
<p>namespace</p>	<p>urn:xmlns:org:eurocris:cerif-1.6-2</p>
<p>type</p>	<p>cfPers_DC_Type</p>
<p>properties</p>	<p>isRef 0 content complex</p>
<p>children</p>	<p>cfPersId cfDCId cfDCScheme cfClassId cfClassSchemeId cfStartDate cfEndDate cfFraction</p>
<p>source</p>	<p><code><xs:element name="cfPers_DC" type="cfPers_DC__Type"/></code></p>

element CERIF/cfProj_DC

<p>diagram</p>	
<p>namespace</p>	<p>urn:xmlns:org:eurocris:cerif-1.6-2</p>
<p>type</p>	<p>cfProj_DC_Type</p>
<p>properties</p>	<p>isRef 0 content complex</p>
<p>children</p>	<p>cfDCId cfDCScheme cfProjId cfClassId cfClassSchemeId cfStartDate cfEndDate cfFraction</p>
<p>source</p>	<p><code><xs:element name="cfProj_DC" type="cfProj_DC__Type"/></code></p>

element CERIF/cfQual

<p>diagram</p>	
<p>namespace</p>	<p>urn:xmls:org:eurocris:cerif-1.6-2</p>
<p>type</p>	<p>cfQual_Type</p>
<p>properties</p>	<p>isRef 0 content complex</p>
<p>children</p>	<p>cfQualId cfURI cfDescr cfKeyw cfTitle cfPers_Qual cfQual_Class cfFedId</p>
<p>source</p>	<p><code><xs:element name="cfQual" type="cfQual_Type"/></code></p>

element CERIF/cfPers_Qual

<p>diagram</p>	
<p>namespace</p>	<p>urn:xmls:org:eurocris:cerif-1.6-2</p>
<p>type</p>	<p>cfPers_Qual_Type</p>
<p>properties</p>	<p>isRef 0 content complex</p>
<p>children</p>	<p>cfPersId cfQualId cfClassId cfClassSchemeld cfStartDate cfEndDate cfFraction</p>
<p>source</p>	<p><code><xs:element name="cfPers_Qual" type="cfPers_Qual_Type"/></code></p>

element CERIF/cfQualDescr

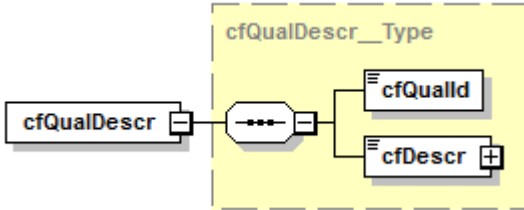
diagram	
namespace	urn:xmlns:org:eurocris:cerif-1.6-2
type	cfQualDescr__Type
properties	isRef 0 content complex
children	cfQualId cfDescr
source	<code><xs:element name="cfQualDescr" type="cfQualDescr__Type"/></code>

element CERIF/cfQualKeyw

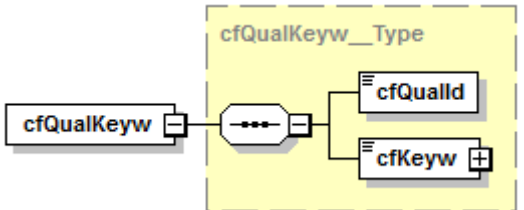
diagram	
namespace	urn:xmlns:org:eurocris:cerif-1.6-2
type	cfQualKeyw__Type
properties	isRef 0 content complex
children	cfQualId cfKeyw
source	<code><xs:element name="cfQualKeyw" type="cfQualKeyw__Type"/></code>

element CERIF/cfQual_Class

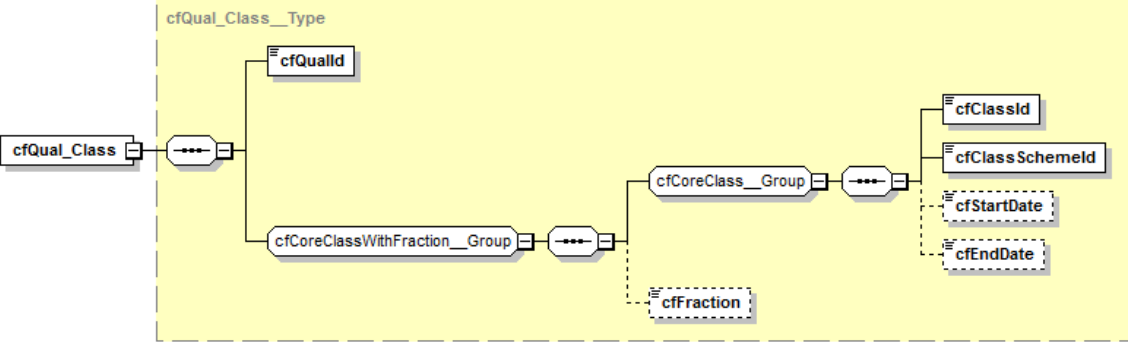
diagram	
namespace	urn:xmlns:org:eurocris:cerif-1.6-2
type	cfQual_Class__Type
properties	isRef 0 content complex
children	cfQualId cfClassId cfClassSchemeld cfStartDate cfEndDate cfFraction
source	<code><xs:element name="cfQual_Class" type="cfQual_Class__Type"/></code>

element CERIF/cfResPubl_DC

diagram	
namespace	urn:xmlns:org:eurocris:cerif-1.6-2
type	cfResPubl_DC_Type
properties	isRef 0 content complex
children	cfResPublId cfDCId cfDCScheme cfClassId cfClassSchemeld cfStartDate cfEndDate cfFraction
source	<xs:element name="cfResPubl_DC" type="cfResPubl_DC_Type"/>

element CERIF/cfCite

diagram	
namespace	urn:xmlns:org:eurocris:cerif-1.6-2
type	cfCite_Type
properties	isRef 0 content complex
children	cfCiteId cfURI cfTitle cfDescr cfResPubl_Cite cfCite_Class cfFedId
source	<xs:element name="cfCite" type="cfCite_Type"/>

element CERIF/cfResPublBibINote

diagram	
namespace	urn:xmlns:org:eurocris:cerif-1.6-2
type	cfResPublBibINote__Type
properties	isRef 0 content complex
children	cfResPublId cfBibINote
source	<code><xs:element name="cfResPublBibINote" type="cfResPublBibINote__Type"/></code>

element CERIF/cfResPublNameAbbrev

diagram	
namespace	urn:xmlns:org:eurocris:cerif-1.6-2
type	cfResPublNameAbbrev__Type
properties	isRef 0 content complex
children	cfResPublId cfNameAbbrev
source	<code><xs:element name="cfResPublNameAbbrev" type="cfResPublNameAbbrev__Type"/></code>

element CERIF/cfEvent_Event

diagram	
namespace	urn:xmlns:org:eurocris:cerif-1.6-2
type	cfEvent_Event__Type
properties	isRef 0 content complex
children	cfEventId1 cfEventId2 cfClassId cfClassSchemeld cfStartDate cfEndDate cfFraction
source	<code><xs:element name="cfEvent_Event" type="cfEvent_Event__Type"/></code>

element CERIF/cfResPublSubtitle

diagram	
namespace	urn.xmlns:org:eurocris:cerif-1.6-2
type	cfResPublSubtitle_Type
properties	isRef 0 content complex
children	cfResPublId cfSubtitle
source	<code><xs:element name="cfResPublSubtitle" type="cfResPublSubtitle__Type"/></code>

element CERIF/cfResPubl_Cite

diagram	
namespace	urn.xmlns:org:eurocris:cerif-1.6-2
type	cfResPubl_Cite_Type
properties	isRef 0 content complex
children	cfResPublId cfCiteId cfClassId cfClassSchemeld cfStartDate cfEndDate cfFraction cfYear cfCount
source	<code><xs:element name="cfResPubl_Cite" type="cfResPubl_Cite__Type"/></code>

element CERIF/cfCite_Class

diagram	
namespace	urn.xmlns:org:eurocris:cerif-1.6-2
type	cfCite_Class_Type
properties	isRef 0 content complex
children	cfCiteId cfClassId cfClassSchemeld cfStartDate cfEndDate cfFraction
source	<code><xs:element name="cfCite_Class" type="cfCite_Class__Type"/></code>

namespace	urn:xmlns:org:eurocris:cerif-1.6-2
type	cfCite_Class_Type
properties	isRef 0 content complex
children	cfCiteId cfClassId cfClassSchemeId cfStartDate cfEndDate cfFraction
source	<code><xs:element name="cfCite_Class" type="cfCite_Class_Type"/></code>

element CERIF/cfPersName

diagram	
namespace	urn:xmlns:org:eurocris:cerif-1.6-2
type	cfPersName_Type
properties	isRef 0 content complex
children	cfPersNameId cfFamilyNames cfFirstNames cfOtherNames cfPersName_Pers
source	<code><xs:element name="cfPersName" type="cfPersName_Type"/></code>

element CERIF/cfPersName_Pers

diagram	
namespace	urn:xmlns:org:eurocris:cerif-1.6-2

type	cfPersName_Pers_Type
properties	isRef 0 content complex
children	cfPersNameId cfPersId cfClassId cfClassSchemeId cfStartDate cfEndDate cfFamilyNames cfFirstNames cfOtherNames
source	<code><xs:element name="cfPersName_Pers" type="cfPersName_Pers__Type"/></code>

element CERIF/cfCiteTitle

diagram	
namespace	urn.xmlns:org:eurocris:cerif-1.6-2
type	cfCiteTitle_Type
properties	isRef 0 content complex
children	cfCiteId cfTitle
source	<code><xs:element name="cfCiteTitle" type="cfCiteTitle__Type"/></code>

element CERIF/cfCiteDescr

diagram	
namespace	urn.xmlns:org:eurocris:cerif-1.6-2
type	cfCiteDescr_Type
properties	isRef 0 content complex
children	cfCiteId cfDescr
source	<code><xs:element name="cfCiteDescr" type="cfCiteDescr__Type"/></code>

element CERIF/cfClassDef

diagram	
namespace	urn.xmlns:org:eurocris:cerif-1.6-2

type	cfClassDef_Type
properties	isRef 0 content complex
children	cfClassId cfClassSchemeId cfDef cfDefSrc
source	<code><xs:element name="cfClassDef" type="cfClassDef__Type"/></code>

element CERIF/cfClassSchemeName

diagram	
namespace	urn:xmlns:org:eurocris:cerif-1.6-2
type	cfClassSchemeName_Type
properties	isRef 0 content complex
children	cfClassSchemeId cfName cfNameSrc
source	<code><xs:element name="cfClassSchemeName" type="cfClassSchemeName__Type"/></code>

element CERIF/cfClassEx

diagram	
namespace	urn:xmlns:org:eurocris:cerif-1.6-2
type	cfClassEx_Type
properties	isRef 0 content complex
children	cfClassId cfClassSchemeId cfEx cfExSrc
source	<code><xs:element name="cfClassEx" type="cfClassEx__Type"/></code>

element CERIF/cfQualTitle

diagram	
namespace	urn:xmlns:org:eurocris:cerif-1.6-2

type	cfQualTitle_Type
properties	isRef 0 content complex
children	cfQualId cfTitle
source	<code><xs:element name="cfQualTitle" type="cfQualTitle_Type"/></code>

element CERIF/cfResPubVersInfo

diagram	
namespace	urn:xmlns:org:eurocris:cerif-1.6-2
type	cfResPubVersInfo_Type
properties	isRef 0 content complex
children	cfResPubId cfVersInfo
source	<code><xs:element name="cfResPubVersInfo" type="cfResPubVersInfo_Type"/></code>

element CERIF/cfFedId

diagram	
namespace	urn:xmlns:org:eurocris:cerif-1.6-2
type	cfFedId_Type
properties	isRef 0 content complex
children	cfFedIdId cfInstId cfFedId cfClassId cfClassSchemeld cfStartDate cfEndDate cfFedId_Class cfFedId_Srv
source	<code><xs:element name="cfFedId" type="cfFedId_Type"/></code>

element CERIF/cfFedId_Class

diagram	
namespace	urn:xmlns:org:eurocris:cerif-1.6-2
type	cfFedId_Class_Type
properties	isRef 0 content complex
children	cfFedIdId cfClassId cfClassSchemeld cfStartDate cfEndDate cfFraction
source	<code><xs:element name="cfFedId_Class" type="cfFedId_Class__Type"/></code>

group cfCoreClass_Group

diagram	
namespace	urn:xmlns:org:eurocris:cerif-1.6-2
children	cfClassId cfClassSchemeld cfStartDate cfEndDate
used by	elements cfPers_Type/cfPersName_Pers cfPersName_Type/cfPersName_Pers complexTypes cfClass_Type cfCoreClass_Type cfFedId_Type cfPersName_Pers_Type group cfCoreClassWithFraction_Group
source	<pre> <xs:group name="cfCoreClass_Group"> <xs:sequence> <xs:element name="cfClassId" type="cfd__Type"/> <xs:element name="cfClassSchemeld" type="cfd__Type"/> <xs:element name="cfStartDate" type="xs:dateTime" minOccurs="0"/> <xs:element name="cfEndDate" type="xs:dateTime" minOccurs="0"/> </xs:sequence> </xs:group> </pre>

element cfCoreClass_Group/cfClassId

diagram	
namespace	urn:xmlns:org:eurocris:cerif-1.6-2
type	cfd_Type
properties	isRef 0 content simple
facets	Kind Value annotation maxLength 128
source	<code><xs:element name="cfClassId" type="cfd__Type"/></code>

element **cfCoreClass_Group**/cfClassSchemeld

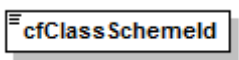
diagram	
namespace	urn.xmlns:org:eurocris:cerif-1.6-2
type	cfd_Type
properties	isRef 0 content simple
facets	Kind Value annotation maxLength 128
source	<code><xs:element name="cfClassSchemeld" type="cfd__Type"/></code>

element **cfCoreClass_Group**/cfStartDate

diagram	
namespace	urn.xmlns:org:eurocris:cerif-1.6-2
type	xs:dateTime
properties	isRef 0 minOcc 0 maxOcc 1 content simple
source	<code><xs:element name="cfStartDate" type="xs:dateTime" minOccurs="0"/></code>

element **cfCoreClass_Group**/cfEndDate

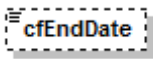
diagram	
namespace	urn.xmlns:org:eurocris:cerif-1.6-2
type	xs:dateTime
properties	isRef 0 minOcc 0 maxOcc 1 content simple
source	<code><xs:element name="cfEndDate" type="xs:dateTime" minOccurs="0"/></code>

group **cfCoreClassWithFraction_Group**

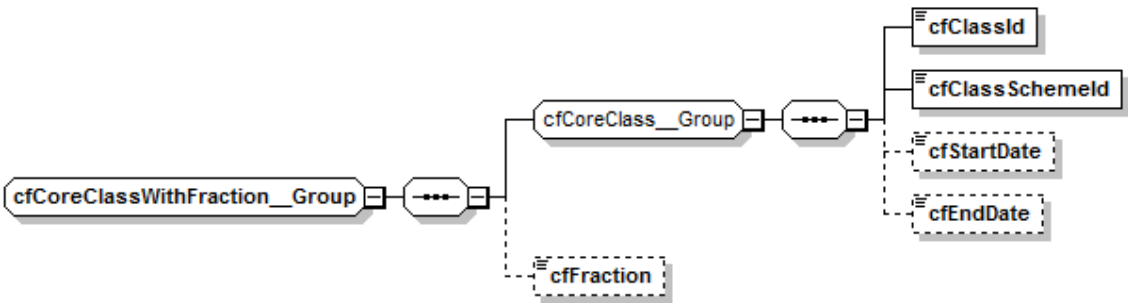
diagram	
namespace	urn.xmlns:org:eurocris:cerif-1.6-2
children	cfClassId cfClassSchemeld cfStartDate cfEndDate cfFraction
used by	elements cfClass_Type/cfClass_Class cfClassScheme_Type/cfClassScheme_Class cfEvent_Type/cfEvent_Event cfEvent_Type/cfEvent_Fund cfFund_Type/cfFund_Indic cfEvent_Type/cfEvent_Indic cfMeas_Type/cfEvent_Meas cfEvent_Type/cfEvent_Meas cfFedld_Type/cfFedld_Srv cfFund_Type/cfFund_Fund cfFund_Type/cfFund_Indic cfIndic_Type/cfFund_Indic cfFund_Type/cfFund_Meas cfMeas_Type/cfFund_Meas cfIndic_Type/cfIndic_Indic cfMeas_Type/cfIndic_Meas cfIndic_Type/cfIndic_Meas cfMeas_Type/cfMeas_Meas cfDC_Type/cfOrgUnit_DC cfOrgUnit_Type/cfOrgUnit_DC cfEAddr_Type/cfOrgUnit_EAddr cfOrgUnit_Type/cfOrgUnit_EAddr

	<p>cfEvent Type/cfOrgUnit Event cfOrgUnit Type/cfOrgUnit Event cfFund Type/cfOrgUnit Fund cfOrgUnit Type/cfOrgUnit Fund cfOrgUnit Type/cfOrgUnit Indic cfIndic Type/cfOrgUnit Indic cfOrgUnit Type/cfOrgUnit Meas cfMeas Type/cfOrgUnit Meas cfOrgUnit Type/cfOrgUnit OrgUnit cfPAddr Type/cfOrgUnit PAddr cfOrgUnit Type/cfOrgUnit PAddr cfResPubl Type/cfOrgUnit ResPubl cfOrgUnit Type/cfOrgUnit ResPubl cfCountry Type/cfPers Country cfPers Type/cfPers Country cfCV Type/cfPers CV cfPers Type/cfPers CV cfDC Type/cfPers DC cfPers Type/cfPers DC cfEAddr Type/cfPers EAddr cfPers Type/cfPers EAddr cfEvent Type/cfPers Event cfPers Type/cfPers Event cfFund Type/cfPers Fund cfPers Type/cfPers Fund cfPers Type/cfPers Indic cfIndic Type/cfPers Indic cfPers Type/cfPers Lang cfLang Type/cfPers Lang cfMeas Type/cfPers Meas cfPers Type/cfPers Meas cfPers Type/cfPers OrgUnit cfOrgUnit Type/cfPers OrgUnit cfPers Type/cfPers PAddr cfPAddr Type/cfPers PAddr cfPers Type/cfPers Pers cfQual Type/cfPers Qual cfPers Type/cfPers Qual cfResPubl Type/cfPers ResPubl cfPers Type/cfPers ResPubl cfDC Type/cfProj DC cfProj Type/cfProj DC cfProj Type/cfProj Event cfEvent Type/cfProj Event cfProj Type/cfProj Fund cfFund Type/cfProj Fund cfIndic Type/cfProj Indic cfProj Type/cfProj Indic cfMeas Type/cfProj Meas cfProj Type/cfProj Meas cfProj Type/cfProj OrgUnit cfOrgUnit Type/cfProj OrgUnit cfProj Type/cfProj Pers cfPers Type/cfProj Pers cfProj Type/cfProj Proj cfResPubl Type/cfProj ResPubl cfProj Type/cfProj ResPubl cfCite Type/cfResPubl Cite cfResPubl Type/cfResPubl Cite cfResPubl Type/cfResPubl DC cfDC Type/cfResPubl DC cfEvent Type/cfResPubl Event cfResPubl Type/cfResPubl Event cfResPubl Type/cfResPubl Fund cfFund Type/cfResPubl Fund cfIndic Type/cfResPubl Indic cfResPubl Type/cfResPubl Indic cfResPubl Type/cfResPubl Meas cfMeas Type/cfResPubl Meas cfResPubl Type/cfResPubl Metrics cfMetrics Type/cfResPubl Metrics cfResPubl Type/cfResPubl ResPubl cfCite Class Type cfClass Class Type cfClassScheme ClassScheme Type cfCoreClassWithFraction Type cfCountry Class Type cfCurrency Class Type cfCV Class Type cfEAddr Class Type cfEvent Class Type cfEvent Event Type cfEvent Fund Type cfEvent Indic Type cfEvent Meas Type cfFedld Class Type cfFund Class Type cfFund Fund Type cfIndic Class Type cfIndic Indic Type cfIndic Meas Type cfLang Class Type cfMeas Class Type cfMeas Meas Type cfMetrics Class Type cfOrgUnit Class Type cfOrgUnit DC Type cfOrgUnit EAddr Type cfOrgUnit Event Type cfOrgUnit Fund Type cfOrgUnit Indic Type cfOrgUnit Meas Type cfOrgUnit OrgUnit Type cfOrgUnit PAddr Type cfOrgUnit ResPubl Type cfPAddr Class Type cfPers Class Type cfPers Country Type cfPers CV Type cfPers DC Type cfPers EAddr Type cfPers Event Type cfPers Fund Type cfPers Indic Type cfPers Lang Type cfPers Meas Type cfPers OrgUnit Type cfPers PAddr Type cfPers Pers Type cfPers Qual Type cfPers ResPubl Type cfProj Class Type cfProj DC Type cfProj Event Type cfProj Fund Type cfProj Indic Type cfProj Meas Type cfProj OrgUnit Type cfProj Pers Type cfProj Proj Type cfProj ResPubl Type cfQual Class Type cfResPubl Cite Type cfResPubl Class Type cfResPubl DC Type cfResPubl Event Type cfResPubl Fund Type cfResPubl Indic Type cfResPubl ResPubl Type</p>
source	<pre><xs:group name="cfCoreClassWithFraction__Group"> <xs:sequence> <xs:group ref="cfCoreClass__Group"/> <xs:element name="cfFraction" type="xs:float" minOccurs="0"/> </xs:sequence> </xs:group></pre>

element cfCoreClassWithFraction_Group/cfFraction

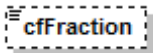
diagram	
namespace	urn:xmlns:org:eurocris:cerif-1.6-2
type	xs:float
properties	isRef 0 minOcc 0 maxOcc 1 content simple
source	<pre><xs:element name="cfFraction" type="xs:float" minOccurs="0"/></pre>

complexType **cfAmount__Type**

diagram													
namespace	urn:xmlns:org:eurocris:cerif-1.6-2												
type	extension of xs:float												
properties	base xs:float												
used by	elements cfEvent_Type/cfEvent_Fund/cfAmount cfEvent_Fund_Type/cfAmount cfFund_Type/cfAmount cfFund_Type/cfEvent_Fund/cfAmount cfFund_Type/cfOrgUnit_Fund/cfAmount cfFund_Type/cfPers_Fund/cfAmount cfFund_Type/cfProj_Fund/cfAmount cfFund_Type/cfResPubl_Fund/cfAmount cfFund_Type/cfFund_Indic/cfAmount cfFund_Type/cfFund_Meas/cfAmount cfOrgUnit_Type/cfOrgUnit_Fund/cfAmount cfOrgUnit_Fund_Type/cfAmount cfPers_Type/cfPers_Fund/cfAmount cfPers_Fund_Type/cfAmount cfProj_Type/cfProj_Fund/cfAmount cfProj_Fund_Type/cfAmount cfResPubl_Type/cfResPubl_Fund/cfAmount cfResPubl_Fund_Type/cfAmount cfMeas_Type/cfFund_Meas/cfAmount cfIndic_Type/cfFund_Indic/cfAmount cfFund_Indic_Type/cfAmount cfFund_Meas_Type/cfAmount cfOrgUnit_Type/cfTurn												
attributes	<table border="1"> <thead> <tr> <th>Name</th> <th>Type</th> <th>Use</th> <th>Default</th> <th>Fixed</th> <th>annotation</th> </tr> </thead> <tbody> <tr> <td>cfCurrCode</td> <td>xs:string</td> <td>required</td> <td></td> <td></td> <td></td> </tr> </tbody> </table>	Name	Type	Use	Default	Fixed	annotation	cfCurrCode	xs:string	required			
Name	Type	Use	Default	Fixed	annotation								
cfCurrCode	xs:string	required											
source	<pre><xs:complexType name="cfAmount__Type"> <xs:simpleContent> <xs:extension base="xs:float"> <xs:attribute name="cfCurrCode" type="xs:string" use="required"/> </xs:extension> </xs:simpleContent> </xs:complexType></pre>												

attribute **cfAmount__Type/@cfCurrCode**

type	xs:string
properties	isRef 0 use required
source	<pre><xs:attribute name="cfCurrCode" type="xs:string" use="required"/></pre>

complexType **cfCite__Type**

diagram	
namespace	urn:xmlns:org:eurocris:cerif-1.6-2
children	cfCiteId cfURI cfTitle cfDescr cfResPubl_Cite cfCite_Class cfFedId
used by	element CERIF/cfCite
source	<pre><xs:complexType name="cfCite__Type"> <xs:sequence> <xs:element name="cfCiteId" type="cfId__Type"/></pre>

	<pre> <xs:element name="cfURI" type="xs:string" minOccurs="0"/> <xs:choice minOccurs="0" maxOccurs="unbounded"> <!-- embedded multiple-language attributes --> <xs:element name="cfTitle" type="cfMLangString__Type"/> <xs:element name="cfDescr" type="cfMLangString__Type"/> <!-- embedded linking entities --> <xs:element name="cfResPubl_Cite"> <xs:complexType> <xs:sequence> <xs:element name="cfResPublId" type="cfId__Type"/> <xs:group ref="cfCoreClassWithFraction__Group"/> <xs:element name="cfYear" type="xs:int" minOccurs="0"/> <xs:element name="cfCount" type="xs:float" minOccurs="0"/> </xs:sequence> </xs:complexType> </xs:element> <xs:element name="cfCite_Class" type="cfCoreClassWithFraction__Type"/> <!-- embedded federated identifiers --> <xs:element name="cfFedId" type="cfFedId__EmbType"/> </xs:choice> </xs:sequence> </xs:complexType> </pre>
--	--

element **cfCite__Type/cfCiteld**

diagram	
namespace	urn:xmlns:org:eurocris:cerif-1.6-2
type	cfId__Type
properties	isRef 0 content simple
facets	Kind Value annotation maxLength 128
source	<pre><xs:element name="cfCiteld" type="cfId__Type"/></pre>

element **cfCite__Type/cfURI**

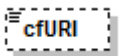
diagram	
namespace	urn:xmlns:org:eurocris:cerif-1.6-2
type	xs:string
properties	isRef 0 minOcc 0 maxOcc 1 content simple
source	<pre><xs:element name="cfURI" type="xs:string" minOccurs="0"/></pre>

element cfCite_Type/cfTitle

diagram						
namespace	urn:xmlns:org:eurocris:cerif-1.6-2					
type	cfMLangString_Type					
properties	isRef	0	content	complex		
attributes	Name	Type	Use	Default	Fixed	annotation
	cfLangCode	xs:string	required			
	cfTrans	cfTrans_Type	required			
source	<code><xs:element name="cfTitle" type="cfMLangString_Type"/></code>					

element cfCite_Type/cfDescr

diagram						
namespace	urn:xmlns:org:eurocris:cerif-1.6-2					
type	cfMLangString_Type					
properties	isRef	0	content	complex		
attributes	Name	Type	Use	Default	Fixed	annotation
	cfLangCode	xs:string	required			
	cfTrans	cfTrans_Type	required			
source	<code><xs:element name="cfDescr" type="cfMLangString_Type"/></code>					

element cfCite_Type/cfResPubl_Cite

diagram						
namespace	urn:xmlns:org:eurocris:cerif-1.6-2					

properties	isRef 0 content complex
children	cfResPublId cfClassId cfClassSchemeId cfStartDate cfEndDate cfFraction cfYear cfCount
source	<pre><xs:element name="cfResPubl_Cite"> <xs:complexType> <xs:sequence> <xs:element name="cfResPublId" type="cfId__Type"/> <xs:group ref="cfCoreClassWithFraction__Group"/> <xs:element name="cfYear" type="xs:int" minOccurs="0"/> <xs:element name="cfCount" type="xs:float" minOccurs="0"/> </xs:sequence> </xs:complexType> </xs:element></pre>

element **cfCite__Type/cfResPubl_Cite/cfResPublId**

diagram	
namespace	urn:xmlns:org:eurocris:cerif-1.6-2
type	cfId__Type
properties	isRef 0 content simple
facets	Kind Value annotation maxLength 128
source	<pre><xs:element name="cfResPublId" type="cfId__Type"/></pre>

element **cfCite__Type/cfResPubl_Cite/cfYear**

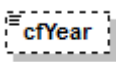
diagram	
namespace	urn:xmlns:org:eurocris:cerif-1.6-2
type	xs:int
properties	isRef 0 minOcc 0 maxOcc 1 content simple
source	<pre><xs:element name="cfYear" type="xs:int" minOccurs="0"/></pre>

element **cfCite__Type/cfResPubl_Cite/cfCount**

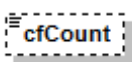
diagram	
namespace	urn:xmlns:org:eurocris:cerif-1.6-2
type	xs:float
properties	isRef 0 minOcc 0 maxOcc 1 content simple
source	<pre><xs:element name="cfCount" type="xs:float" minOccurs="0"/></pre>

element cfCite_Type/cfCite_Class

diagram	
namespace	urn:xmlns:org:eurocris:cerif-1.6-2
type	cfCoreClassWithFraction_Type
properties	isRef 0 content complex
children	cfClassId cfClassSchemeld cfStartDate cfEndDate cfFraction
source	<code><xs:element name="cfCite_Class" type="cfCoreClassWithFraction_Type"/></code>

element cfCite_Type/cfFedId

diagram	
namespace	urn:xmlns:org:eurocris:cerif-1.6-2
type	cfFedId_EmbType
properties	isRef 0 content complex
children	cfFedIdId cfFedId cfClassId cfClassSchemeld cfStartDate cfEndDate cfFedId_Class
source	<code><xs:element name="cfFedId" type="cfFedId__EmbType"/></code>

complexType cfCite_Class_Type

diagram	
---------	--

namespace	urn:xmlns:org:eurocris:cerif-1.6-2
children	cfCiteId cfClassId cfClassSchemeld cfStartDate cfEndDate cfFraction
used by	element CERIF/cfCite_Class
source	<pre><xs:complexType name="cfCite_Class__Type"> <xs:sequence> <xs:element name="cfCiteId" type="cfId__Type"/> <xs:group ref="cfCoreClassWithFraction__Group"/> </xs:sequence> </xs:complexType></pre>

element [cfCite_Class__Type/cfCiteId](#)

diagram	
namespace	urn:xmlns:org:eurocris:cerif-1.6-2
type	cfId__Type
properties	isRef 0 content simple
facets	Kind Value annotation maxLength 128
source	<pre><xs:element name="cfCiteId" type="cfId__Type"/></pre>

complexType [cfCiteDescr__Type](#)

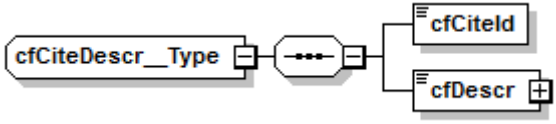
diagram	
namespace	urn:xmlns:org:eurocris:cerif-1.6-2
children	cfCiteId cfDescr
used by	element CERIF/cfCiteDescr
source	<pre><xs:complexType name="cfCiteDescr__Type"> <xs:sequence> <xs:element name="cfCiteId" type="cfId__Type"/> <xs:element name="cfDescr" type="cfMLangString__Type"/> </xs:sequence> </xs:complexType></pre>

element [cfCiteDescr__Type/cfCiteId](#)

diagram	
namespace	urn:xmlns:org:eurocris:cerif-1.6-2
type	cfId__Type
properties	isRef 0 content simple
facets	Kind Value annotation maxLength 128
source	<pre><xs:element name="cfCiteId" type="cfId__Type"/></pre>

element **cfCiteDescr__Type**/cfDescr

diagram						
namespace	urn:xmlns:org:eurocris:cerif-1.6-2					
type	cfMLangString__Type					
properties	isRef	0	content	complex		
attributes	Name	Type	Use	Default	Fixed	annotation
	cfLangCode	xs:string	required			
	cfTrans	cfTrans__Type	required			
source	<code><xs:element name="cfDescr" type="cfMLangString__Type"/></code>					

complexType **cfCiteTitle__Type**

diagram						
namespace	urn:xmlns:org:eurocris:cerif-1.6-2					
children	cfCiteId cfTitle					
used by	element	CERIF/cfCiteTitle				
source	<pre> <xs:complexType name="cfCiteTitle__Type"> <xs:sequence> <xs:element name="cfCiteId" type="cfId__Type"/> <xs:element name="cfTitle" type="cfMLangString__Type"/> </xs:sequence> </xs:complexType> </pre>					

element **cfCiteTitle__Type**/cfCiteId

diagram						
namespace	urn:xmlns:org:eurocris:cerif-1.6-2					
type	cfId__Type					
properties	isRef	0	content	simple		
facets	Kind	Value	annotation			
	maxLength	128				
source	<code><xs:element name="cfCiteId" type="cfId__Type"/></code>					

element cfCiteTitle__Type/cfTitle

diagram						
namespace	urn:xmlns:org:eurocris:cerif-1.6-2					
type	cfMLangString__Type					
properties	isRef	0	content	complex		
attributes	Name	Type	Use	Default	Fixed	annotation
	cfLangCode	xs:string	required			
	cfTrans	cfTrans__Type	required			
source	<code><xs:element name="cfTitle" type="cfMLangString__Type"/></code>					

complexType cfClass__Type

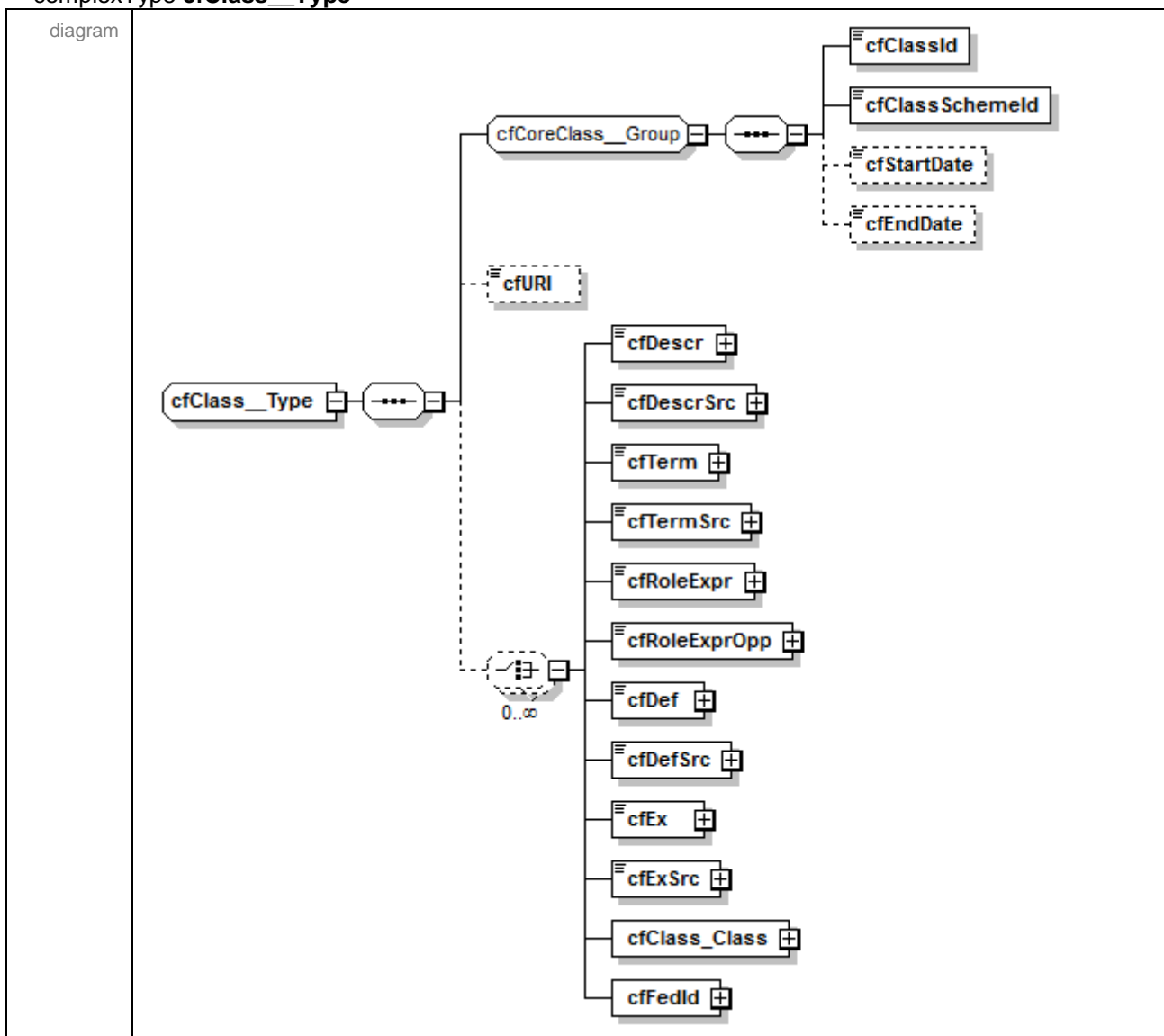

namespace	urn:xmlns:org:eurocris:cerif-1.6-2
children	cfClassId cfClassSchemeld cfStartDate cfEndDate cfURI cfDescr cfDescrSrc cfTerm cfTermSrc cfRoleExpr cfRoleExprOpp cfDef cfDefSrc cfEx cfExSrc cfClass Class cfFedld
used by	element CERIF/cfClass
source	<pre> <xs:complexType name="cfClass__Type"> <xs:sequence> <xs:group ref="cfCoreClass__Group"/> <xs:element name="cfURI" type="xs:string" minOccurs="0"/> <xs:choice minOccurs="0" maxOccurs="unbounded"> <!-- embedded multiple-language attributes --> <xs:element name="cfDescr" type="cfMLangString__Type"/> <xs:element name="cfDescrSrc" type="cfMLangString__Type"/> <xs:element name="cfTerm" type="cfMLangString__Type"/> <xs:element name="cfTermSrc" type="cfMLangString__Type"/> <xs:element name="cfRoleExpr" type="cfMLangString__Type"/> <xs:element name="cfRoleExprOpp" type="cfMLangString__Type"/> <xs:element name="cfDef" type="cfMLangString__Type"/> <xs:element name="cfDefSrc" type="cfMLangString__Type"/> <xs:element name="cfEx" type="cfMLangString__Type"/> <xs:element name="cfExSrc" type="cfMLangString__Type"/> <!-- embedded linking entities --> <xs:element name="cfClass_Class"> <xs:complexType> <xs:sequence> <xs:choice> <xs:sequence> <xs:element name="cfClassId2" type="cfId__Type"/> <xs:element name="cfClassSchemeld2" type="cfId__Type"/> </xs:sequence> <xs:sequence> <xs:element name="cfClassId1" type="cfId__Type"/> <xs:element name="cfClassSchemeld1" type="cfId__Type"/> </xs:sequence> </xs:choice> <xs:group ref="cfCoreClassWithFraction__Group"/> </xs:sequence> </xs:complexType> </xs:element> <!-- embedded federated identifiers --> <xs:element name="cfFedld" type="cfFedld__EmbType"/> </xs:choice> </xs:sequence> </xs:complexType> </pre>

element **cfClass__Type/cfURI**

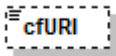
diagram									
namespace	urn:xmlns:org:eurocris:cerif-1.6-2								
type	xs:string								
properties	<table> <tr> <td>isRef</td> <td>0</td> </tr> <tr> <td>minOcc</td> <td>0</td> </tr> <tr> <td>maxOcc</td> <td>1</td> </tr> <tr> <td>content</td> <td>simple</td> </tr> </table>	isRef	0	minOcc	0	maxOcc	1	content	simple
isRef	0								
minOcc	0								
maxOcc	1								
content	simple								
source	<pre><xs:element name="cfURI" type="xs:string" minOccurs="0"/></pre>								

element **cfClass__Type/cfDescr**

diagram						
namespace	urn:xmlns:org:eurocris:cerif-1.6-2					
type	cfMLangString__Type					
properties	isRef	0	content	complex		
attributes	Name	Type	Use	Default	Fixed	annotation
	cfLangCode	xs:string	required			
	cfTrans	cfTrans__Type	required			
source	<code><xs:element name="cfDescr" type="cfMLangString__Type"/></code>					

element **cfClass__Type/cfDescrSrc**

diagram						
namespace	urn:xmlns:org:eurocris:cerif-1.6-2					
type	cfMLangString__Type					
properties	isRef	0	content	complex		
attributes	Name	Type	Use	Default	Fixed	annotation
	cfLangCode	xs:string	required			
	cfTrans	cfTrans__Type	required			
source	<code><xs:element name="cfDescrSrc" type="cfMLangString__Type"/></code>					

element **cfClass__Type/cfTerm**

diagram						
namespace	urn:xmlns:org:eurocris:cerif-1.6-2					
type	cfMLangString__Type					
properties	isRef	0	content	complex		

attributes	Name	Type	Use	Default	Fixed	annotation
	cfLangCode	xs:string	required			
	cfTrans	cfTrans_Type	required			
source	<code><xs:element name="cfTerm" type="cfMLangString__Type"/></code>					

element **cfClass_Type/cfTermSrc**

diagram						
namespace	urn.xmlns:org:eurocris:cerif-1.6-2					
type	cfMLangString_Type					
properties	isRef	0				
	content	complex				
attributes	Name	Type	Use	Default	Fixed	annotation
	cfLangCode	xs:string	required			
	cfTrans	cfTrans_Type	required			
source	<code><xs:element name="cfTermSrc" type="cfMLangString__Type"/></code>					

element **cfClass_Type/cfRoleExpr**

diagram						
namespace	urn.xmlns:org:eurocris:cerif-1.6-2					
type	cfMLangString_Type					
properties	isRef	0				
	content	complex				
attributes	Name	Type	Use	Default	Fixed	annotation
	cfLangCode	xs:string	required			
	cfTrans	cfTrans_Type	required			
source	<code><xs:element name="cfRoleExpr" type="cfMLangString__Type"/></code>					

element cfClass__Type/cfRoleExprOpp

diagram						
namespace	urn:xmlns:org:eurocris:cerif-1.6-2					
type	cfMLangString__Type					
properties	isRef	0	content	complex		
attributes	Name	Type	Use	Default	Fixed	annotation
	cfLangCode	xs:string	required			
	cfTrans	cfTrans__Type	required			
source	<code><xs:element name="cfRoleExprOpp" type="cfMLangString__Type"/></code>					

element cfClass__Type/cfDef

diagram						
namespace	urn:xmlns:org:eurocris:cerif-1.6-2					
type	cfMLangString__Type					
properties	isRef	0	content	complex		
attributes	Name	Type	Use	Default	Fixed	annotation
	cfLangCode	xs:string	required			
	cfTrans	cfTrans__Type	required			
source	<code><xs:element name="cfDef" type="cfMLangString__Type"/></code>					

element cfClass__Type/cfDefSrc

diagram						
namespace	urn:xmlns:org:eurocris:cerif-1.6-2					
type	cfMLangString__Type					
properties	isRef	0	content	complex		

attributes	Name	Type	Use	Default	Fixed	annotation
	cfLangCode	xs:string	required			
	cfTrans	cfTrans_Type	required			
source	<code><xs:element name="cfDefSrc" type="cfMLangString__Type"/></code>					

element **cfClass_Type/cfEx**

diagram						
namespace	urn.xmlns:org:eurocris:cerif-1.6-2					
type	cfMLangString_Type					
properties	isRef	0				
	content	complex				
attributes	Name	Type	Use	Default	Fixed	annotation
	cfLangCode	xs:string	required			
	cfTrans	cfTrans_Type	required			
source	<code><xs:element name="cfEx" type="cfMLangString__Type"/></code>					

element **cfClass_Type/cfExSrc**

diagram						
namespace	urn.xmlns:org:eurocris:cerif-1.6-2					
type	cfMLangString_Type					
properties	isRef	0				
	content	complex				
attributes	Name	Type	Use	Default	Fixed	annotation
	cfLangCode	xs:string	required			
	cfTrans	cfTrans_Type	required			
source	<code><xs:element name="cfExSrc" type="cfMLangString__Type"/></code>					

element cfClass_Type/cfClass_Class

diagram	
namespace	urn.xmlns:org:eurocris:cerif-1.6-2
properties	isRef 0 content complex
children	cfClassId2 cfClassSchemeld2 cfClassId1 cfClassSchemeld1 cfClassId cfClassSchemeld cfStartDate cfEndDate cfFraction
source	<pre> <xs:element name="cfClass_Class"> <xs:complexType> <xs:sequence> <xs:choice> <xs:sequence> <xs:element name="cfClassId2" type="cflD__Type"/> <xs:element name="cfClassSchemeld2" type="cflD__Type"/> </xs:sequence> <xs:sequence> <xs:element name="cfClassId1" type="cflD__Type"/> <xs:element name="cfClassSchemeld1" type="cflD__Type"/> </xs:sequence> </xs:choice> <xs:group ref="cfCoreClassWithFraction__Group"/> </xs:sequence> </xs:complexType> </xs:element> </pre>

element cfClass_Type/cfClass_Class/cfClassId2

diagram	
namespace	urn.xmlns:org:eurocris:cerif-1.6-2
type	cflD_Type
properties	isRef 0 content simple
facets	Kind Value annotation maxLength 128
source	<pre><xs:element name="cfClassId2" type="cflD__Type"/></pre>

element cfClass_Type/cfClass_Class/cfClassSchemeld2

diagram	
namespace	urn.xmlns:org:eurocris:cerif-1.6-2
type	cflD_Type

properties	isRef 0 content simple
facets	Kind Value annotation maxLength 128
source	<xs:element name="cfClassSchemeld2" type="cfId__Type"/>

element cfClass_Type/cfClass_Class/cfClassId1

diagram	
namespace	urn:xmlns:org:eurocris:cerif-1.6-2
type	cfId_Type
properties	isRef 0 content simple
facets	Kind Value annotation maxLength 128
source	<xs:element name="cfClassId1" type="cfId__Type"/>

element cfClass_Type/cfClass_Class/cfClassSchemeld1

diagram	
namespace	urn:xmlns:org:eurocris:cerif-1.6-2
type	cfId_Type
properties	isRef 0 content simple
facets	Kind Value annotation maxLength 128
source	<xs:element name="cfClassSchemeld1" type="cfId__Type"/>

element cfClass_Type/cfFedId

diagram	
namespace	urn:xmlns:org:eurocris:cerif-1.6-2
type	cfFedId_EmbType
properties	isRef 0 content complex
children	cfFedIdId cfFedId cfClassId cfClassSchemeld cfStartDate cfEndDate cfFedId_Class
source	<xs:element name="cfFedId" type="cfFedId__EmbType"/>

complexType cfClass_Class_Type

diagram	
namespace	urn:xmlns:org:eurocris:cerif-1.6-2
children	cfClassId1 cfClassId2 cfClassSchemeld1 cfClassSchemeld2 cfClassId cfClassSchemeld cfStartDate cfEndDate cfFraction
used by	element CERIF/cfClass_Class
source	<pre> <xs:complexType name="cfClass_Class_Type"> <xs:sequence> <xs:element name="cfClassId1" type="cfd__Type"/> <xs:element name="cfClassId2" type="cfd__Type"/> <xs:element name="cfClassSchemeld1" type="cfd__Type"/> <xs:element name="cfClassSchemeld2" type="cfd__Type"/> <xs:group ref="cfCoreClassWithFraction_Group"/> </xs:sequence> </xs:complexType> </pre>

element cfClass_Class_Type/cfClassId1

diagram	
namespace	urn:xmlns:org:eurocris:cerif-1.6-2
type	cfd__Type
properties	isRef 0 content simple
facets	Kind Value annotation maxLength 128
source	<pre><xs:element name="cfClassId1" type="cfd__Type"/></pre>

element cfClass_Class_Type/cfClassId2

diagram	
namespace	urn:xmlns:org:eurocris:cerif-1.6-2
type	cfd__Type
properties	isRef 0 content simple
facets	Kind Value annotation maxLength 128
source	<pre><xs:element name="cfClassId2" type="cfd__Type"/></pre>

element **cfClass_Class_Type/cfClassSchemeld1**

diagram	
namespace	urn.xmlns:org:eurocris:cerif-1.6-2
type	cfld_Type
properties	isRef 0 content simple
facets	Kind Value annotation maxLength 128
source	<code><xs:element name="cfClassSchemeld1" type="cfld__Type"/></code>

element **cfClass_Class_Type/cfClassSchemeld2**

diagram	
namespace	urn.xmlns:org:eurocris:cerif-1.6-2
type	cfld_Type
properties	isRef 0 content simple
facets	Kind Value annotation maxLength 128
source	<code><xs:element name="cfClassSchemeld2" type="cfld__Type"/></code>

complexType **cfClassDef__Type**

diagram	
namespace	urn.xmlns:org:eurocris:cerif-1.6-2
children	cfClassId cfClassSchemeld cfDef cfDefSrc
used by	element CERIF/cfClassDef
source	<pre><xs:complexType name="cfClassDef__Type"> <xs:sequence> <xs:element name="cfClassId" type="cfld__Type"/> <xs:element name="cfClassSchemeld" type="cfld__Type"/> <xs:element name="cfDef" type="cfMLangString__Type"/> <xs:element name="cfDefSrc" type="cfMLangString__Type" minOccurs="0"/> </xs:sequence> </xs:complexType></pre>

element **cfClassDef__Type/cfClassId**

diagram	
namespace	urn.xmlns:org:eurocris:cerif-1.6-2
type	cfld_Type
properties	isRef 0 content simple
facets	Kind Value annotation

	maxLength 128
source	<xs:element name="cfClassId" type="cfd__Type"/>

element cfClassDef__Type/cfClassSchemeld

diagram	
namespace	urn:xmlns:org:eurocris:cerif-1.6-2
type	cfd__Type
properties	isRef 0 content simple
facets	Kind Value annotation maxLength 128
source	<xs:element name="cfClassSchemeld" type="cfd__Type"/>

element cfClassDef__Type/cfDef

diagram																			
namespace	urn:xmlns:org:eurocris:cerif-1.6-2																		
type	cfMLangString__Type																		
properties	isRef 0 content complex																		
attributes	<table border="1"> <thead> <tr> <th>Name</th> <th>Type</th> <th>Use</th> <th>Default</th> <th>Fixed</th> <th>annotation</th> </tr> </thead> <tbody> <tr> <td>cfLangCode</td> <td>xs:string</td> <td>required</td> <td></td> <td></td> <td></td> </tr> <tr> <td>cfTrans</td> <td>cfTrans__Type</td> <td>required</td> <td></td> <td></td> <td></td> </tr> </tbody> </table>	Name	Type	Use	Default	Fixed	annotation	cfLangCode	xs:string	required				cfTrans	cfTrans__Type	required			
Name	Type	Use	Default	Fixed	annotation														
cfLangCode	xs:string	required																	
cfTrans	cfTrans__Type	required																	
source	<xs:element name="cfDef" type="cfMLangString__Type"/>																		

element cfClassDef__Type/cfDefSrc

diagram																			
namespace	urn:xmlns:org:eurocris:cerif-1.6-2																		
type	cfMLangString__Type																		
properties	isRef 0 minOcc 0 maxOcc 1 content complex																		
attributes	<table border="1"> <thead> <tr> <th>Name</th> <th>Type</th> <th>Use</th> <th>Default</th> <th>Fixed</th> <th>annotation</th> </tr> </thead> <tbody> <tr> <td>cfLangCode</td> <td>xs:string</td> <td>required</td> <td></td> <td></td> <td></td> </tr> <tr> <td>cfTrans</td> <td>cfTrans__Type</td> <td>required</td> <td></td> <td></td> <td></td> </tr> </tbody> </table>	Name	Type	Use	Default	Fixed	annotation	cfLangCode	xs:string	required				cfTrans	cfTrans__Type	required			
Name	Type	Use	Default	Fixed	annotation														
cfLangCode	xs:string	required																	
cfTrans	cfTrans__Type	required																	

source	<xs:element name="cfDefSrc" type="cfMLangString__Type" minOccurs="0"/>
--------	--

complexType cfClassDescr__Type

diagram	
namespace	urn:xmlns:org:eurocris:cerif-1.6-2
children	cfClassId cfClassSchemeld cfDescr cfDescrSrc
used by	element CERIF/cfClassDescr
source	<pre><xs:complexType name="cfClassDescr__Type"> <xs:sequence> <xs:element name="cfClassId" type="cfId__Type"/> <xs:element name="cfClassSchemeld" type="cfId__Type"/> <xs:element name="cfDescr" type="cfMLangString__Type"/> <xs:element name="cfDescrSrc" type="cfMLangString__Type" minOccurs="0"/> </xs:sequence> </xs:complexType></pre>

element cfClassDescr__Type/cfClassId

diagram	
namespace	urn:xmlns:org:eurocris:cerif-1.6-2
type	cfId__Type
properties	isRef 0 content simple
facets	Kind Value annotation maxLength 128
source	<xs:element name="cfClassId" type="cfId__Type"/>

element cfClassDescr__Type/cfClassSchemeld

diagram	
namespace	urn:xmlns:org:eurocris:cerif-1.6-2
type	cfId__Type
properties	isRef 0 content simple
facets	Kind Value annotation maxLength 128
source	<xs:element name="cfClassSchemeld" type="cfId__Type"/>

element **cfClassDescr__Type/cfDescr**

diagram						
namespace	urn:xmlns:org:eurocris:cerif-1.6-2					
type	cfMLangString__Type					
properties	isRef	0	content	complex		
attributes	Name	Type	Use	Default	Fixed	annotation
	cfLangCode	xs:string	required			
	cfTrans	cfTrans__Type	required			
source	<code><xs:element name="cfDescr" type="cfMLangString__Type"/></code>					

element **cfClassDescr__Type/cfDescrSrc**

diagram						
namespace	urn:xmlns:org:eurocris:cerif-1.6-2					
type	cfMLangString__Type					
properties	isRef	0	minOcc	0	maxOcc	1
	content	complex				
attributes	Name	Type	Use	Default	Fixed	annotation
	cfLangCode	xs:string	required			
	cfTrans	cfTrans__Type	required			
source	<code><xs:element name="cfDescrSrc" type="cfMLangString__Type" minOccurs="0"/></code>					

complexType **cfClassEx__Type**

diagram						
namespace	urn:xmlns:org:eurocris:cerif-1.6-2					
children	cfClassId cfClassSchemeld cfEx cfExSrc					
used by	element	CERIF/cfClassEx				

source	<pre><xs:complexType name="cfClassEx__Type"> <xs:sequence> <xs:element name="cfClassId" type="cfd__Type"/> <xs:element name="cfClassSchemeld" type="cfd__Type"/> <xs:element name="cfEx" type="cfMLangString__Type"/> <xs:element name="cfExSrc" type="cfMLangString__Type" minOccurs="0"/> </xs:sequence> </xs:complexType></pre>
--------	--

element **cfClassEx__Type/cfClassId**

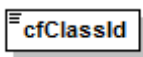
diagram	
namespace	urn.xmlns:org:eurocris:cerif-1.6-2
type	cfd__Type
properties	isRef 0 content simple
facets	Kind Value annotation maxLength 128
source	<pre><xs:element name="cfClassId" type="cfd__Type"/></pre>

element **cfClassEx__Type/cfClassSchemeld**

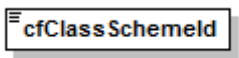
diagram	
namespace	urn.xmlns:org:eurocris:cerif-1.6-2
type	cfd__Type
properties	isRef 0 content simple
facets	Kind Value annotation maxLength 128
source	<pre><xs:element name="cfClassSchemeld" type="cfd__Type"/></pre>

element **cfClassEx__Type/cfEx**

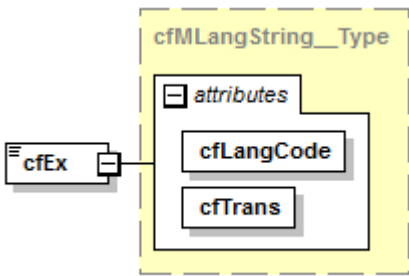
diagram																			
namespace	urn.xmlns:org:eurocris:cerif-1.6-2																		
type	cfMLangString__Type																		
properties	isRef 0 content complex																		
attributes	<table border="1"> <thead> <tr> <th>Name</th> <th>Type</th> <th>Use</th> <th>Default</th> <th>Fixed</th> <th>annotation</th> </tr> </thead> <tbody> <tr> <td>cfLangCode</td> <td>xs:string</td> <td>required</td> <td></td> <td></td> <td></td> </tr> <tr> <td>cfTrans</td> <td>cfTrans__Type</td> <td>required</td> <td></td> <td></td> <td></td> </tr> </tbody> </table>	Name	Type	Use	Default	Fixed	annotation	cfLangCode	xs:string	required				cfTrans	cfTrans__Type	required			
Name	Type	Use	Default	Fixed	annotation														
cfLangCode	xs:string	required																	
cfTrans	cfTrans__Type	required																	
source	<pre><xs:element name="cfEx" type="cfMLangString__Type"/></pre>																		

element **cfClassEx__Type**/cfExSrc

diagram						
namespace	urn.xmlns:org:eurocris:cerif-1.6-2					
type	cfMLangString__Type					
properties	isRef	0				
	minOcc	0				
	maxOcc	1				
	content	complex				
attributes	Name	Type	Use	Default	Fixed	annotation
	cfLangCode	xs:string	required			
	cfTrans	cfTrans__Type	required			
source	<pre><xs:element name="cfExSrc" type="cfMLangString__Type" minOccurs="0"/></pre>					

complexType **cfClassScheme__Type**

diagram						
namespace	urn.xmlns:org:eurocris:cerif-1.6-2					
children	cfClassSchemeld cfURI cfDescr cfDescrSrc cfName cfNameSrc cfClassScheme ClassScheme cfFedld cfClass					
used by	element	CERIF/cfClassScheme				
source	<pre><xs:complexType name="cfClassScheme__Type"> <xs:sequence> <xs:element name="cfClassSchemeld" type="cfId__Type"/> <xs:element name="cfURI" type="xs:string" minOccurs="0"/> <xs:choice minOccurs="0" maxOccurs="unbounded"> <!-- embedded multiple-language attributes --> <xs:element name="cfDescr" type="cfMLangString__Type"/> <xs:element name="cfDescrSrc" type="cfMLangString__Type"/> <xs:element name="cfName" type="cfMLangString__Type"/> <xs:element name="cfNameSrc" type="cfMLangString__Type"/> <!-- embedded linking entities --> <xs:element name="cfClassScheme_ClassScheme"/> </xs:sequence> </xs:complexType></pre>					

```

<xs:complexType>
  <xs:sequence>
    <xs:choice>
      <xs:element name="cfClassSchemeld2" type="cfId__Type"/>
      <xs:element name="cfClassSchemeld1" type="cfId__Type"/>
    </xs:choice>
    <xs:group ref="cfCoreClassWithFraction__Group"/>
  </xs:sequence>
</xs:complexType>
</xs:element>
<!-- embedded federated identifiers -->
<xs:element name="cfFedId" type="cfFedId__EmbType"/>
<!-- embedded cfClass -->
<xs:element name="cfClass">
  <xs:complexType>
    <xs:sequence>
      <xs:element name="cfClassId" type="cfId__Type"/>
      <xs:element name="cfStartDate" type="xs:dateTime" minOccurs="0"/>
      <xs:element name="cfEndDate" type="xs:dateTime" minOccurs="0"/>
      <xs:element name="cfURI" type="xs:string" minOccurs="0"/>
      <xs:choice minOccurs="0" maxOccurs="unbounded">
        <!-- embedded multiple-language attributes -->
        <xs:element name="cfDescr" type="cfMLangString__Type"/>
        <xs:element name="cfDescrSrc" type="cfMLangString__Type"/>
        <xs:element name="cfTerm" type="cfMLangString__Type"/>
        <xs:element name="cfTermSrc" type="cfMLangString__Type"/>
        <xs:element name="cfRoleExpr" type="cfMLangString__Type"/>
        <xs:element name="cfRoleExprOpp" type="cfMLangString__Type"/>
        <xs:element name="cfDef" type="cfMLangString__Type"/>
        <xs:element name="cfDefSrc" type="cfMLangString__Type"/>
        <xs:element name="cfEx" type="cfMLangString__Type"/>
        <xs:element name="cfExSrc" type="cfMLangString__Type"/>
        <!-- embedded linking entities -->
        <xs:element name="cfClass_Class">
          <xs:complexType>
            <xs:sequence>
              <xs:choice>
                <xs:sequence>
                  <xs:element name="cfClassId2" type="cfId__Type"/>
                  <xs:element name="cfClassSchemeld2" type="cfId__Type"/>
                </xs:sequence>
                <xs:sequence>
                  <xs:element name="cfClassId1" type="cfId__Type"/>
                  <xs:element name="cfClassSchemeld1" type="cfId__Type"/>
                </xs:sequence>
              </xs:choice>
              <xs:group ref="cfCoreClassWithFraction__Group"/>
            </xs:sequence>
          </xs:complexType>
        </xs:element>
        <!-- embedded federated identifiers -->
        <xs:element name="cfFedId" type="cfFedId__EmbType"/>
      </xs:choice>
    </xs:sequence>
  </xs:complexType>
</xs:element>
</xs:choice>
</xs:sequence>
</xs:complexType>

```

element **cfClassScheme__Type/cfClassSchemeld**

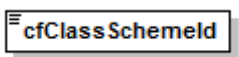
diagram	
namespace	urn.xmlns.org:eurocris:cerif-1.6-2
type	cfd__Type
properties	isRef 0 content simple
facets	Kind Value annotation maxLength 128
source	<code><xs:element name="cfClassSchemeld" type="cfd__Type"/></code>

element **cfClassScheme__Type/cfURI**

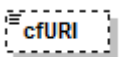
diagram	
namespace	urn.xmlns.org:eurocris:cerif-1.6-2
type	xs:string
properties	isRef 0 minOcc 0 maxOcc 1 content simple
source	<code><xs:element name="cfURI" type="xs:string" minOccurs="0"/></code>

element **cfClassScheme__Type/cfDescr**

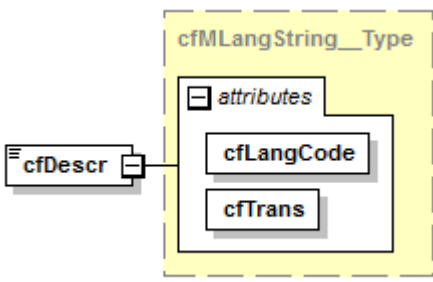
diagram																			
namespace	urn.xmlns.org:eurocris:cerif-1.6-2																		
type	cfMLangString__Type																		
properties	isRef 0 content complex																		
attributes	<table border="1"> <thead> <tr> <th>Name</th> <th>Type</th> <th>Use</th> <th>Default</th> <th>Fixed</th> <th>annotation</th> </tr> </thead> <tbody> <tr> <td>cfLangCode</td> <td>xs:string</td> <td>required</td> <td></td> <td></td> <td></td> </tr> <tr> <td>cfTrans</td> <td>cfTrans__Type</td> <td>required</td> <td></td> <td></td> <td></td> </tr> </tbody> </table>	Name	Type	Use	Default	Fixed	annotation	cfLangCode	xs:string	required				cfTrans	cfTrans__Type	required			
Name	Type	Use	Default	Fixed	annotation														
cfLangCode	xs:string	required																	
cfTrans	cfTrans__Type	required																	
source	<code><xs:element name="cfDescr" type="cfMLangString__Type"/></code>																		

element **cfClassScheme__Type/cfDescrSrc**

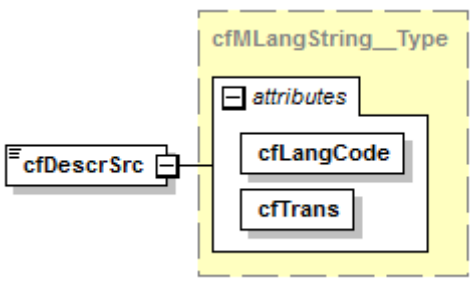
diagram	
namespace	urn.xmlns.org:eurocris:cerif-1.6-2

type	cfMLangString__Type					
properties	isRef	0	content	complex		
attributes	Name	Type	Use	Default	Fixed	annotation
	cfLangCode	xs:string	required			
	cfTrans	cfTrans__Type	required			
source	<code><xs:element name="cfDescrSrc" type="cfMLangString__Type"/></code>					

element **cfClassScheme__Type/cfName**

diagram						
namespace	urn.xmlns:org:eurocris:cerif-1.6-2					
type	cfMLangString__Type					
properties	isRef	0	content	complex		
attributes	Name	Type	Use	Default	Fixed	annotation
	cfLangCode	xs:string	required			
	cfTrans	cfTrans__Type	required			
source	<code><xs:element name="cfName" type="cfMLangString__Type"/></code>					

element **cfClassScheme__Type/cfNameSrc**

diagram						
namespace	urn.xmlns:org:eurocris:cerif-1.6-2					
type	cfMLangString__Type					
properties	isRef	0	content	complex		
attributes	Name	Type	Use	Default	Fixed	annotation
	cfLangCode	xs:string	required			
	cfTrans	cfTrans__Type	required			
source	<code><xs:element name="cfNameSrc" type="cfMLangString__Type"/></code>					

element **cfClassScheme__Type/cfClassScheme_ClassScheme**

diagram	
namespace	urn:xmlns:org:eurocris:cerif-1.6-2
properties	isRef 0 content complex
children	cfClassSchemed2 cfClassSchemed1 cfClassId cfClassSchemed cfStartDate cfEndDate cfFraction
source	<pre><xs:element name="cfClassScheme_ClassScheme"> <xs:complexType> <xs:sequence> <xs:choice> <xs:element name="cfClassSchemed2" type="cfd__Type"/> <xs:element name="cfClassSchemed1" type="cfd__Type"/> </xs:choice> <xs:group ref="cfCoreClassWithFraction__Group"/> </xs:sequence> </xs:complexType> </xs:element></pre>

element **cfClassScheme__Type/cfClassScheme_ClassScheme/cfClassSchemed2**

diagram	
namespace	urn:xmlns:org:eurocris:cerif-1.6-2
type	cfd__Type
properties	isRef 0 content simple
facets	Kind Value annotation maxLength 128
source	<pre><xs:element name="cfClassSchemed2" type="cfd__Type"/></pre>

element **cfClassScheme__Type/cfClassScheme_ClassScheme/cfClassSchemed1**

diagram	
namespace	urn:xmlns:org:eurocris:cerif-1.6-2
type	cfd__Type
properties	isRef 0 content simple
facets	Kind Value annotation maxLength 128
source	<pre><xs:element name="cfClassSchemed1" type="cfd__Type"/></pre>

element cfClassScheme__Type/cfFedId

<p>diagram</p>	
<p>namespace</p>	<p>urn:xmlns:org:eurocris:cerif-1.6-2</p>
<p>type</p>	<p>cfFedId__EmbType</p>
<p>properties</p>	<p>isRef 0 content complex</p>
<p>children</p>	<p>cfFedIdId cfFedId cfClassId cfClassSchemeId cfStartDate cfEndDate cfFedId__Class</p>
<p>source</p>	<p><code><xs:element name="cfFedId" type="cfFedId__EmbType"/></code></p>

element cfClassScheme_Type/cfClass

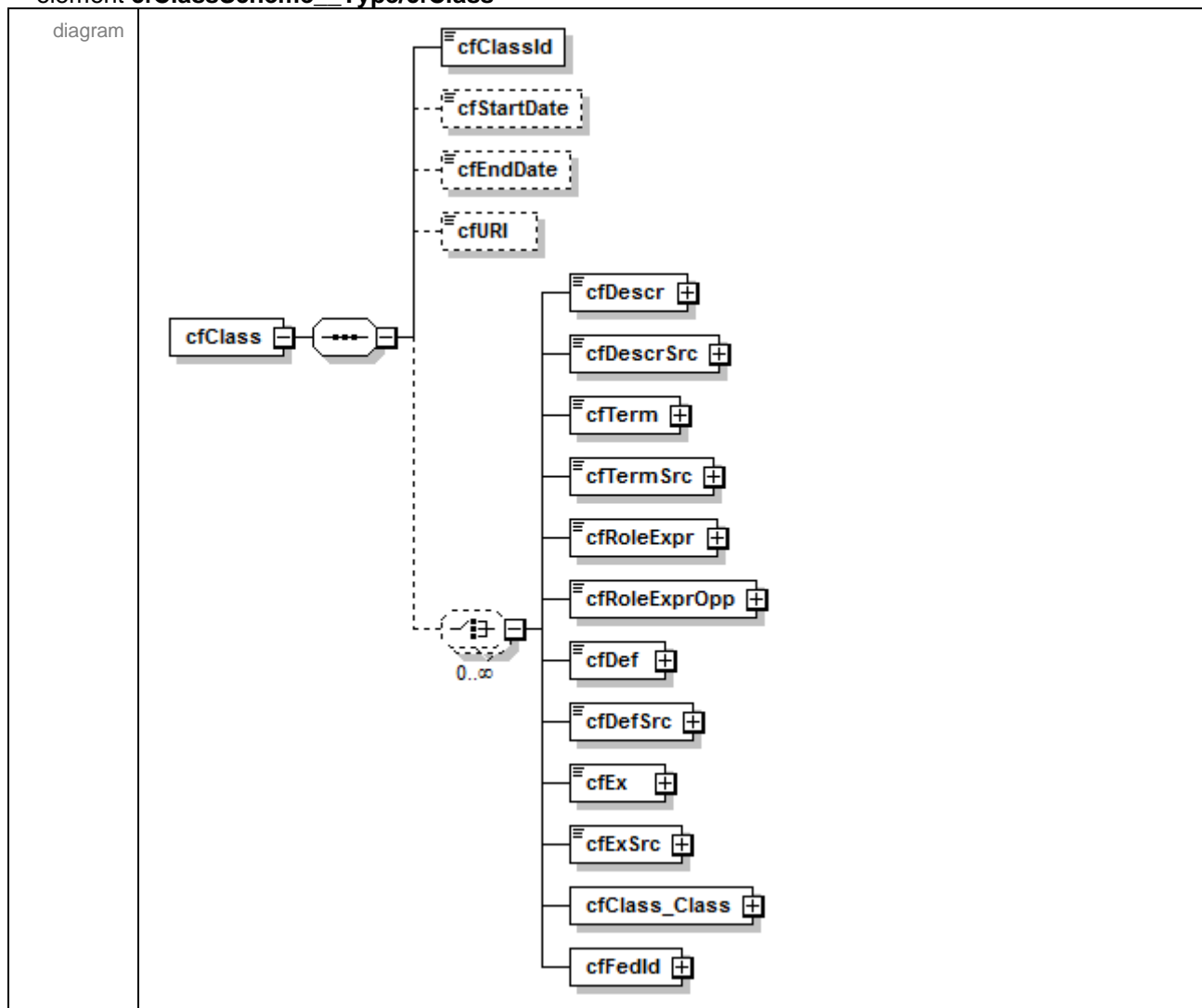

namespace urn:xmlns:org:eurocris:cerif-1.6-2

properties isRef 0 content complex

children [cfClassId](#) [cfStartDate](#) [cfEndDate](#) [cfURI](#) [cfDescr](#) [cfDescrSrc](#) [cfTerm](#) [cfTermSrc](#) [cfRoleExpr](#) [cfRoleExprOpp](#) [cfDef](#) [cfDefSrc](#) [cfEx](#) [cfExSrc](#) [cfClass_Class](#) [cfFedId](#)

```

<xs:element name="cfClass">
  <xs:complexType>
    <xs:sequence>
      <xs:element name="cfClassId" type="cfId__Type"/>
      <xs:element name="cfStartDate" type="xs:dateTime" minOccurs="0"/>
      <xs:element name="cfEndDate" type="xs:dateTime" minOccurs="0"/>
      <xs:element name="cfURI" type="xs:string" minOccurs="0"/>
      <xs:choice minOccurs="0" maxOccurs="unbounded">
        <!-- embedded multiple-language attributes -->
        <xs:element name="cfDescr" type="cfMLangString__Type"/>
        <xs:element name="cfDescrSrc" type="cfMLangString__Type"/>
        <xs:element name="cfTerm" type="cfMLangString__Type"/>
        <xs:element name="cfTermSrc" type="cfMLangString__Type"/>
        <xs:element name="cfRoleExpr" type="cfMLangString__Type"/>
        <xs:element name="cfRoleExprOpp" type="cfMLangString__Type"/>
        <xs:element name="cfDef" type="cfMLangString__Type"/>
        <xs:element name="cfDefSrc" type="cfMLangString__Type"/>
        <xs:element name="cfEx" type="cfMLangString__Type"/>
        <xs:element name="cfExSrc" type="cfMLangString__Type"/>
        <!-- embedded linking entities -->
      </xs:choice>
    </xs:sequence>
  </xs:complexType>
</xs:element>
    
```

	<pre> <xs:element name="cfClass_Class"> <xs:complexType> <xs:sequence> <xs:choice> <xs:sequence> <xs:element name="cfClassId2" type="cfdl__Type"/> <xs:element name="cfClassSchemeld2" type="cfdl__Type"/> </xs:sequence> <xs:sequence> <xs:element name="cfClassId1" type="cfdl__Type"/> <xs:element name="cfClassSchemeld1" type="cfdl__Type"/> </xs:sequence> </xs:choice> <xs:group ref="cfCoreClassWithFraction__Group"/> </xs:sequence> </xs:complexType> </xs:element> <!-- embedded federated identifiers --> <xs:element name="cfFedId" type="cfFedId__EmbType"/> </xs:choice> </xs:sequence> </xs:complexType> </xs:element> </pre>
--	---

element cfClassScheme__Type/cfClass/cfClassId

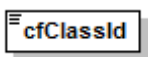
diagram	
namespace	urn:xmlns:org:eurocris:cerif-1.6-2
type	cfdl__Type
properties	isRef 0 content simple
facets	Kind Value annotation maxLength 128
source	<code><xs:element name="cfClassId" type="cfdl__Type"/></code>

element cfClassScheme__Type/cfClass/cfStartDate

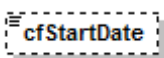
diagram	
namespace	urn:xmlns:org:eurocris:cerif-1.6-2
type	xs:dateTime
properties	isRef 0 minOcc 0 maxOcc 1 content simple
source	<code><xs:element name="cfStartDate" type="xs:dateTime" minOccurs="0"/></code>

element cfClassScheme__Type/cfClass/cfEndDate

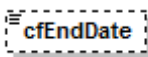
diagram	
namespace	urn:xmlns:org:eurocris:cerif-1.6-2
type	xs:dateTime
properties	isRef 0 minOcc 0 maxOcc 1 content simple

source	<xs:element name="cfEndDate" type="xs:dateTime" minOccurs="0"/>
--------	---

element cfClassScheme__Type/cfClass/cfURI

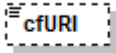
diagram	
namespace	urn:xmlns:org:eurocris:cerif-1.6-2
type	xs:string
properties	isRef 0 minOcc 0 maxOcc 1 content simple
source	<xs:element name="cfURI" type="xs:string" minOccurs="0"/>

element cfClassScheme__Type/cfClass/cfDescr

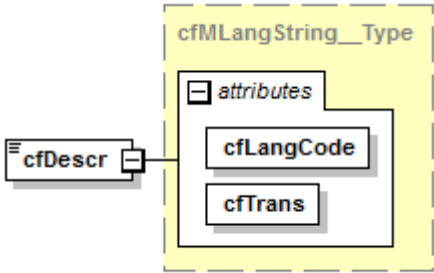
diagram																			
namespace	urn:xmlns:org:eurocris:cerif-1.6-2																		
type	cfMLangString__Type																		
properties	isRef 0 content complex																		
attributes	<table border="1"> <thead> <tr> <th>Name</th> <th>Type</th> <th>Use</th> <th>Default</th> <th>Fixed</th> <th>annotation</th> </tr> </thead> <tbody> <tr> <td>cfLangCode</td> <td>xs:string</td> <td>required</td> <td></td> <td></td> <td></td> </tr> <tr> <td>cfTrans</td> <td>cfTrans__Type</td> <td>required</td> <td></td> <td></td> <td></td> </tr> </tbody> </table>	Name	Type	Use	Default	Fixed	annotation	cfLangCode	xs:string	required				cfTrans	cfTrans__Type	required			
Name	Type	Use	Default	Fixed	annotation														
cfLangCode	xs:string	required																	
cfTrans	cfTrans__Type	required																	
source	<xs:element name="cfDescr" type="cfMLangString__Type"/>																		

element cfClassScheme__Type/cfClass/cfDescrSrc

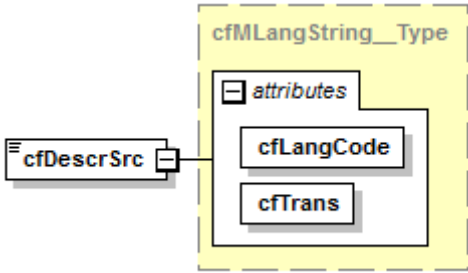
diagram																			
namespace	urn:xmlns:org:eurocris:cerif-1.6-2																		
type	cfMLangString__Type																		
properties	isRef 0 content complex																		
attributes	<table border="1"> <thead> <tr> <th>Name</th> <th>Type</th> <th>Use</th> <th>Default</th> <th>Fixed</th> <th>annotation</th> </tr> </thead> <tbody> <tr> <td>cfLangCode</td> <td>xs:string</td> <td>required</td> <td></td> <td></td> <td></td> </tr> <tr> <td>cfTrans</td> <td>cfTrans__Type</td> <td>required</td> <td></td> <td></td> <td></td> </tr> </tbody> </table>	Name	Type	Use	Default	Fixed	annotation	cfLangCode	xs:string	required				cfTrans	cfTrans__Type	required			
Name	Type	Use	Default	Fixed	annotation														
cfLangCode	xs:string	required																	
cfTrans	cfTrans__Type	required																	
source	<xs:element name="cfDescrSrc" type="cfMLangString__Type"/>																		

element cfClassScheme__Type/cfClass/cfTerm

diagram						
namespace	urn:xmlns:org:eurocris:cerif-1.6-2					
type	cfMLangString__Type					
properties	isRef	0	content	complex		
attributes	Name	Type	Use	Default	Fixed	annotation
	cfLangCode	xs:string	required			
	cfTrans	cfTrans__Type	required			
source	<code><xs:element name="cfTerm" type="cfMLangString__Type"/></code>					

element cfClassScheme__Type/cfClass/cfTermSrc

diagram						
namespace	urn:xmlns:org:eurocris:cerif-1.6-2					
type	cfMLangString__Type					
properties	isRef	0	content	complex		
attributes	Name	Type	Use	Default	Fixed	annotation
	cfLangCode	xs:string	required			
	cfTrans	cfTrans__Type	required			
source	<code><xs:element name="cfTermSrc" type="cfMLangString__Type"/></code>					

element cfClassScheme__Type/cfClass/cfRoleExpr

diagram						
namespace	urn:xmlns:org:eurocris:cerif-1.6-2					
type	cfMLangString__Type					
properties	isRef	0	content	complex		

attributes	Name	Type	Use	Default	Fixed	annotation
	cfLangCode	xs:string	required			
	cfTrans	cfTrans_Type	required			
source	<code><xs:element name="cfRoleExpr" type="cfMLangString__Type"/></code>					

element **cfClassScheme__Type/cfClass/cfRoleExprOpp**

diagram						
namespace	urn.xmlns:org:eurocris:cerif-1.6-2					
type	cfMLangString_Type					
properties	isRef	0				
	content	complex				
attributes	Name	Type	Use	Default	Fixed	annotation
	cfLangCode	xs:string	required			
	cfTrans	cfTrans_Type	required			
source	<code><xs:element name="cfRoleExprOpp" type="cfMLangString__Type"/></code>					

element **cfClassScheme__Type/cfClass/cfDef**

diagram						
namespace	urn.xmlns:org:eurocris:cerif-1.6-2					
type	cfMLangString_Type					
properties	isRef	0				
	content	complex				
attributes	Name	Type	Use	Default	Fixed	annotation
	cfLangCode	xs:string	required			
	cfTrans	cfTrans_Type	required			
source	<code><xs:element name="cfDef" type="cfMLangString__Type"/></code>					

element **cfClassScheme__Type/cfClass/cfDefSrc**

diagram						
namespace	urn:xmlns:org:eurocris:cerif-1.6-2					
type	cfMLangString__Type					
properties	isRef	0	content	complex		
attributes	Name	Type	Use	Default	Fixed	annotation
	cfLangCode	xs:string	required			
	cfTrans	cfTrans__Type	required			
source	<code><xs:element name="cfDefSrc" type="cfMLangString__Type"/></code>					

element **cfClassScheme__Type/cfClass/cfEx**

diagram						
namespace	urn:xmlns:org:eurocris:cerif-1.6-2					
type	cfMLangString__Type					
properties	isRef	0	content	complex		
attributes	Name	Type	Use	Default	Fixed	annotation
	cfLangCode	xs:string	required			
	cfTrans	cfTrans__Type	required			
source	<code><xs:element name="cfEx" type="cfMLangString__Type"/></code>					

element **cfClassScheme__Type/cfClass/cfExSrc**

diagram						
namespace	urn:xmlns:org:eurocris:cerif-1.6-2					
type	cfMLangString__Type					
properties	isRef	0	content	complex		

attributes	Name	Type	Use	Default	Fixed	annotation
	cfLangCode	xs:string	required			
	cfTrans	cfTrans_Type	required			
source	<code><xs:element name="cfExSrc" type="cfMLangString__Type"/></code>					

element **cfClassScheme__Type/cfClass/cfClass_Class**

diagram	
namespace	urn.xmlns:org:eurocris:cerif-1.6-2
properties	isRef 0 content complex
children	cfClassId2 cfClassSchemeld2 cfClassId1 cfClassSchemeld1 cfClassId cfClassSchemeld cfStartDate cfEndDate cfFraction
source	<pre> <xs:element name="cfClass_Class"> <xs:complexType> <xs:sequence> <xs:choice> <xs:sequence> <xs:element name="cfClassId2" type="cfId__Type"/> <xs:element name="cfClassSchemeld2" type="cfId__Type"/> </xs:sequence> <xs:sequence> <xs:element name="cfClassId1" type="cfId__Type"/> <xs:element name="cfClassSchemeld1" type="cfId__Type"/> </xs:sequence> </xs:choice> <xs:group ref="cfCoreClassWithFraction__Group"/> </xs:sequence> </xs:complexType> </xs:element> </pre>

element **cfClassScheme__Type/cfClass/cfClass_Class/cfClassId2**

diagram	
namespace	urn.xmlns:org:eurocris:cerif-1.6-2
type	cfId_Type
properties	isRef 0 content simple
facets	Kind Value annotation maxLength 128
source	<code><xs:element name="cfClassId2" type="cfId__Type"/></code>

element **cfClassScheme__Type/cfClass/cfClass_Class/cfClassSchemeld2**

diagram	
namespace	urn.xmlns:org:eurocris:cerif-1.6-2
type	cfd_Type
properties	isRef 0 content simple
facets	Kind Value annotation maxLength 128
source	<code><xs:element name="cfClassSchemeld2" type="cfd__Type"/></code>

element **cfClassScheme__Type/cfClass/cfClass_Class/cfClassId1**

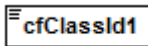
diagram	
namespace	urn.xmlns:org:eurocris:cerif-1.6-2
type	cfd_Type
properties	isRef 0 content simple
facets	Kind Value annotation maxLength 128
source	<code><xs:element name="cfClassId1" type="cfd__Type"/></code>

element **cfClassScheme__Type/cfClass/cfClass_Class/cfClassSchemeld1**

diagram	
namespace	urn.xmlns:org:eurocris:cerif-1.6-2
type	cfd_Type
properties	isRef 0 content simple
facets	Kind Value annotation maxLength 128
source	<code><xs:element name="cfClassSchemeld1" type="cfd__Type"/></code>

element **cfClassScheme__Type/cfClass/cfFedId**

diagram	
namespace	urn:xmlns:org:eurocris:cerif-1.6-2
type	cfFedId__EmbType
properties	isRef 0 content complex
children	cfFedIdId cfFedId cfClassId cfClassSchemeld cfStartDate cfEndDate cfFedId__Class
source	<code><xs:element name="cfFedId" type="cfFedId__EmbType"/></code>

complexType **cfClassScheme__ClassScheme__Type**

diagram	
namespace	urn:xmlns:org:eurocris:cerif-1.6-2
children	cfClassSchemeld1 cfClassSchemeld2 cfClassId cfClassSchemeld cfStartDate cfEndDate cfFraction
used by	element CERIF/cfClassScheme__ClassScheme
source	<pre> <xs:complexType name="cfClassScheme__ClassScheme__Type"> <xs:sequence> <xs:element name="cfClassSchemeld1" type="cfd__Type"/> <xs:element name="cfClassSchemeld2" type="cfd__Type"/> <xs:group ref="cfCoreClassWithFraction__Group"/> </xs:sequence> </xs:complexType> </pre>

element **cfClassScheme__ClassScheme__Type/cfClassSchemeld1**

diagram	
namespace	urn:xmlns:org:eurocris:cerif-1.6-2
type	cfd__Type

properties	isRef 0 content simple
facets	Kind Value annotation maxLength 128
source	<code><xs:element name="cfClassScheme1" type="cfd__Type"/></code>

element cfClassScheme_ClassScheme_Type/cfClassScheme2

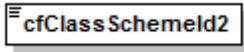
diagram	
namespace	urn:xmlns:org:eurocris:cerif-1.6-2
type	cfd__Type
properties	isRef 0 content simple
facets	Kind Value annotation maxLength 128
source	<code><xs:element name="cfClassScheme2" type="cfd__Type"/></code>

complexType cfClassSchemeDescr_Type

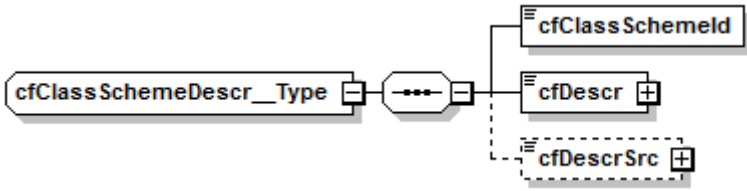
diagram	
namespace	urn:xmlns:org:eurocris:cerif-1.6-2
children	cfClassScheme1 cfDescr cfDescrSrc
used by	element CERIF/cfClassSchemeDescr
source	<pre><xs:complexType name="cfClassSchemeDescr_Type"> <xs:sequence> <xs:element name="cfClassScheme1" type="cfd__Type"/> <xs:element name="cfDescr" type="cfMLangString_Type"/> <xs:element name="cfDescrSrc" type="cfMLangString_Type" minOccurs="0"/> </xs:sequence> </xs:complexType></pre>

element cfClassSchemeDescr_Type/cfClassScheme1

diagram	
namespace	urn:xmlns:org:eurocris:cerif-1.6-2
type	cfd__Type
properties	isRef 0 content simple
facets	Kind Value annotation maxLength 128
source	<code><xs:element name="cfClassScheme1" type="cfd__Type"/></code>

element **cfClassSchemeDescr__Type/cfDescr**

diagram																			
namespace	urn:xmlns:org:eurocris:cerif-1.6-2																		
type	cfMLangString__Type																		
properties	isRef 0 content complex																		
attributes	<table border="1"> <thead> <tr> <th>Name</th> <th>Type</th> <th>Use</th> <th>Default</th> <th>Fixed</th> <th>annotation</th> </tr> </thead> <tbody> <tr> <td>cfLangCode</td> <td>xs:string</td> <td>required</td> <td></td> <td></td> <td></td> </tr> <tr> <td>cfTrans</td> <td>cfTrans__Type</td> <td>required</td> <td></td> <td></td> <td></td> </tr> </tbody> </table>	Name	Type	Use	Default	Fixed	annotation	cfLangCode	xs:string	required				cfTrans	cfTrans__Type	required			
Name	Type	Use	Default	Fixed	annotation														
cfLangCode	xs:string	required																	
cfTrans	cfTrans__Type	required																	
source	<code><xs:element name="cfDescr" type="cfMLangString__Type"/></code>																		

element **cfClassSchemeDescr__Type/cfDescrSrc**

diagram																			
namespace	urn:xmlns:org:eurocris:cerif-1.6-2																		
type	cfMLangString__Type																		
properties	isRef 0 minOcc 0 maxOcc 1 content complex																		
attributes	<table border="1"> <thead> <tr> <th>Name</th> <th>Type</th> <th>Use</th> <th>Default</th> <th>Fixed</th> <th>annotation</th> </tr> </thead> <tbody> <tr> <td>cfLangCode</td> <td>xs:string</td> <td>required</td> <td></td> <td></td> <td></td> </tr> <tr> <td>cfTrans</td> <td>cfTrans__Type</td> <td>required</td> <td></td> <td></td> <td></td> </tr> </tbody> </table>	Name	Type	Use	Default	Fixed	annotation	cfLangCode	xs:string	required				cfTrans	cfTrans__Type	required			
Name	Type	Use	Default	Fixed	annotation														
cfLangCode	xs:string	required																	
cfTrans	cfTrans__Type	required																	
source	<code><xs:element name="cfDescrSrc" type="cfMLangString__Type" minOccurs="0"/></code>																		

complexType **cfClassSchemeName__Type**

diagram	
namespace	urn:xmlns:org:eurocris:cerif-1.6-2
children	cfClassSchemeld cfName cfNameSrc
used by	element CERIF/cfClassSchemeName
source	<code><xs:complexType name="cfClassSchemeName__Type"> <xs:sequence></code>

```
<xs:element name="cfClassSchemeld" type="cfId__Type"/>
<xs:element name="cfName" type="cfMLangString__Type"/>
<xs:element name="cfNameSrc" type="cfMLangString__Type" minOccurs="0"/>
</xs:sequence>
</xs:complexType>
```

element cfClassSchemeName__Type/cfClassSchemeld

diagram	
namespace	urn:xmlns:org:eurocris:cerif-1.6-2
type	cfId__Type
properties	isRef 0 content simple
facets	Kind Value annotation maxLength 128
source	<xs:element name="cfClassSchemeld" type="cfId__Type"/>

element cfClassSchemeName__Type/cfName

diagram																			
namespace	urn:xmlns:org:eurocris:cerif-1.6-2																		
type	cfMLangString__Type																		
properties	isRef 0 content complex																		
attributes	<table border="1"> <thead> <tr> <th>Name</th> <th>Type</th> <th>Use</th> <th>Default</th> <th>Fixed</th> <th>annotation</th> </tr> </thead> <tbody> <tr> <td>cfLangCode</td> <td>xs:string</td> <td>required</td> <td></td> <td></td> <td></td> </tr> <tr> <td>cfTrans</td> <td>cfTrans__Type</td> <td>required</td> <td></td> <td></td> <td></td> </tr> </tbody> </table>	Name	Type	Use	Default	Fixed	annotation	cfLangCode	xs:string	required				cfTrans	cfTrans__Type	required			
Name	Type	Use	Default	Fixed	annotation														
cfLangCode	xs:string	required																	
cfTrans	cfTrans__Type	required																	
source	<xs:element name="cfName" type="cfMLangString__Type"/>																		

element cfClassSchemeName__Type/cfNameSrc

diagram													
namespace	urn:xmlns:org:eurocris:cerif-1.6-2												
type	cfMLangString__Type												
properties	isRef 0 minOcc 0 maxOcc 1 content complex												
attributes	<table border="1"> <thead> <tr> <th>Name</th> <th>Type</th> <th>Use</th> <th>Default</th> <th>Fixed</th> <th>annotation</th> </tr> </thead> <tbody> <tr> <td></td> <td></td> <td></td> <td></td> <td></td> <td></td> </tr> </tbody> </table>	Name	Type	Use	Default	Fixed	annotation						
Name	Type	Use	Default	Fixed	annotation								

	cfLangCode	xs:string	required
	cfTrans	cfTrans_Type	required
source	<xs:element name="cfNameSrc" type="cfMLangString_Type" minOccurs="0"/>		

complexType **cfClassTerm_Type**

diagram	
namespace	urn.xmlns.org:eurocris:cerif-1.6-2
children	cfClassId cfClassSchemeld cfTerm cfTermSrc cfRoleExpr cfRoleExprOpp
used by	element CERIF/cfClassTerm
source	<pre><xs:complexType name="cfClassTerm_Type"> <xs:sequence> <xs:element name="cfClassId" type="cfld_Type"/> <xs:element name="cfClassSchemeld" type="cfld_Type"/> <xs:element name="cfTerm" type="cfMLangString_Type"/> <xs:element name="cfTermSrc" type="cfMLangString_Type" minOccurs="0"/> <xs:element name="cfRoleExpr" type="cfMLangString_Type" minOccurs="0"/> <xs:element name="cfRoleExprOpp" type="cfMLangString_Type" minOccurs="0"/> </xs:sequence> </xs:complexType></pre>

element **cfClassTerm_Type/cfClassId**

diagram	
namespace	urn.xmlns.org:eurocris:cerif-1.6-2
type	cfld_Type
properties	isRef 0 content simple
facets	Kind Value annotation maxLength 128
source	<xs:element name="cfClassId" type="cfld_Type"/>

element **cfClassTerm_Type/cfClassSchemeld**

diagram	
namespace	urn.xmlns.org:eurocris:cerif-1.6-2
type	cfld_Type
properties	isRef 0 content simple
facets	Kind Value annotation maxLength 128
source	<xs:element name="cfClassSchemeld" type="cfld_Type"/>

element **cfClassTerm__Type/cfTerm**

diagram						
namespace	urn:xmlns:org:eurocris:cerif-1.6-2					
type	cfMLangString__Type					
properties	isRef	0	content	complex		
attributes	Name	Type	Use	Default	Fixed	annotation
	cfLangCode	xs:string	required			
	cfTrans	cfTrans__Type	required			
source	<code><xs:element name="cfTerm" type="cfMLangString__Type"/></code>					

element **cfClassTerm__Type/cfTermSrc**

diagram						
namespace	urn:xmlns:org:eurocris:cerif-1.6-2					
type	cfMLangString__Type					
properties	isRef	0	minOcc	0	maxOcc	1
	content	complex				
attributes	Name	Type	Use	Default	Fixed	annotation
	cfLangCode	xs:string	required			
	cfTrans	cfTrans__Type	required			
source	<code><xs:element name="cfTermSrc" type="cfMLangString__Type" minOccurs="0"/></code>					

element **cfClassTerm__Type/cfRoleExpr**

diagram						
namespace	urn:xmlns:org:eurocris:cerif-1.6-2					
type	cfMLangString__Type					

properties	isRef 0 minOcc 0 maxOcc 1 content complex																		
attributes	<table border="1"> <thead> <tr> <th>Name</th> <th>Type</th> <th>Use</th> <th>Default</th> <th>Fixed</th> <th>annotation</th> </tr> </thead> <tbody> <tr> <td>cfLangCode</td> <td>xs:string</td> <td>required</td> <td></td> <td></td> <td></td> </tr> <tr> <td>cfTrans</td> <td>cfTrans_Type</td> <td>required</td> <td></td> <td></td> <td></td> </tr> </tbody> </table>	Name	Type	Use	Default	Fixed	annotation	cfLangCode	xs:string	required				cfTrans	cfTrans_Type	required			
Name	Type	Use	Default	Fixed	annotation														
cfLangCode	xs:string	required																	
cfTrans	cfTrans_Type	required																	
source	<xs:element name="cfRoleExpr" type="cfMLangString__Type" minOccurs="0"/>																		

element cfClassTerm__Type/cfRoleExprOpp

diagram																			
namespace	urn.xmlns.org:eurocris:cerif-1.6-2																		
type	cfMLangString_Type																		
properties	isRef 0 minOcc 0 maxOcc 1 content complex																		
attributes	<table border="1"> <thead> <tr> <th>Name</th> <th>Type</th> <th>Use</th> <th>Default</th> <th>Fixed</th> <th>annotation</th> </tr> </thead> <tbody> <tr> <td>cfLangCode</td> <td>xs:string</td> <td>required</td> <td></td> <td></td> <td></td> </tr> <tr> <td>cfTrans</td> <td>cfTrans_Type</td> <td>required</td> <td></td> <td></td> <td></td> </tr> </tbody> </table>	Name	Type	Use	Default	Fixed	annotation	cfLangCode	xs:string	required				cfTrans	cfTrans_Type	required			
Name	Type	Use	Default	Fixed	annotation														
cfLangCode	xs:string	required																	
cfTrans	cfTrans_Type	required																	
source	<xs:element name="cfRoleExprOpp" type="cfMLangString__Type" minOccurs="0"/>																		

complexType cfCoreClass__Type

diagram	
namespace	urn.xmlns.org:eurocris:cerif-1.6-2
children	cfClassId cfClassSchemeld cfStartDate cfEndDate
source	<pre><xs:complexType name="cfCoreClass__Type"> <xs:sequence> <xs:group ref="cfCoreClass__Group"/> </xs:sequence> </xs:complexType></pre>

complexType cfCoreClassWithFraction__Type

diagram	
namespace	urn:xmlns:org:eurocris:cerif-1.6-2
children	cfClassId cfClassSchemeId cfStartDate cfEndDate cfFraction
used by	elements cfCite_Type/cfCite_Class cfCountry_Type/cfCountry_Class cfCurrency_Type/cfCurrency_Class cfCV_Type/cfCV_Class cfEAddr_Type/cfEAddr_Class cfEvent_Type/cfEvent_Class cfFedId_EmbType/cfFedId_Class cfFedId_Type/cfFedId_Class cfFund_Type/cfFund_Class cfIndic_Type/cfIndic_Class cfLang_Type/cfLang_Class cfMeas_Type/cfMeas_Class cfMetrics_Type/cfMetrics_Class cfOrgUnit_Type/cfOrgUnit_Class cfPAddr_Type/cfPAddr_Class cfPers_Type/cfPers_Class cfProj_Type/cfProj_Class cfQual_Type/cfQual_Class cfResPubl_Type/cfResPubl_Class
source	<pre><xs:complexType name="cfCoreClassWithFraction__Type"> <xs:sequence> <xs:group ref="cfCoreClassWithFraction__Group"/> </xs:sequence> </xs:complexType></pre>

complexType cfCountry__Type

diagram	
namespace	urn:xmlns:org:eurocris:cerif-1.6-2
children	cfCountryCode cfURI cfName cfPers_Country cfCountry_Class cfFedId
used by	element CERIF/cfCountry
source	<pre><xs:complexType name="cfCountry__Type"> <xs:sequence> <xs:element name="cfCountryCode" type="xs:string"/> <xs:element name="cfURI" type="xs:string" minOccurs="0"/> <xs:choice minOccurs="0" maxOccurs="unbounded"> <!-- embedded multiple-language attributes --> <xs:element name="cfName" type="cfMLangString__Type"/> <!-- embedded linking entities --> <xs:element name="cfPers_Country"> <xs:complexType> <xs:sequence> <xs:element name="cfPersId" type="cfId__Type"/> <xs:group ref="cfCoreClassWithFraction__Group"/> </xs:sequence> </xs:complexType> </xs:element> <xs:element name="cfCountry_Class" type="cfCoreClassWithFraction__Type"/> <!-- embedded federated identifiers --> </xs:choice> </xs:sequence> </xs:complexType></pre>

	<pre><xs:element name="cfFedId" type="cfFedId__EmbType"/> </xs:choice> </xs:sequence> </xs:complexType></pre>
--	---

element cfCountry__Type/cfCountryCode

diagram	
namespace	urn:xmlns:org:eurocris:cerif-1.6-2
type	xs:string
properties	isRef 0 content simple
source	<pre><xs:element name="cfCountryCode" type="xs:string"/></pre>

element cfCountry__Type/cfURI

diagram	
namespace	urn:xmlns:org:eurocris:cerif-1.6-2
type	xs:string
properties	isRef 0 minOcc 0 maxOcc 1 content simple
source	<pre><xs:element name="cfURI" type="xs:string" minOccurs="0"/></pre>

element cfCountry__Type/cfName

diagram																			
namespace	urn:xmlns:org:eurocris:cerif-1.6-2																		
type	cfMLangString__Type																		
properties	isRef 0 content complex																		
attributes	<table border="1"> <thead> <tr> <th>Name</th> <th>Type</th> <th>Use</th> <th>Default</th> <th>Fixed</th> <th>annotation</th> </tr> </thead> <tbody> <tr> <td>cfLangCode</td> <td>xs:string</td> <td>required</td> <td></td> <td></td> <td></td> </tr> <tr> <td>cfTrans</td> <td>cfTrans__Type</td> <td>required</td> <td></td> <td></td> <td></td> </tr> </tbody> </table>	Name	Type	Use	Default	Fixed	annotation	cfLangCode	xs:string	required				cfTrans	cfTrans__Type	required			
Name	Type	Use	Default	Fixed	annotation														
cfLangCode	xs:string	required																	
cfTrans	cfTrans__Type	required																	
source	<pre><xs:element name="cfName" type="cfMLangString__Type"/></pre>																		

element **cfCountry__Type/cfPers_Country**

diagram	
namespace	urn.xmlns:org.eurocris:cerif-1.6-2
properties	isRef 0 content complex
children	cfPersId cfClassId cfClassSchemeld cfStartDate cfEndDate cfFraction
source	<pre> <xs:element name="cfPers_Country"> <xs:complexType> <xs:sequence> <xs:element name="cfPersId" type="cflD__Type"/> <xs:group ref="cfCoreClassWithFraction__Group"/> </xs:sequence> </xs:complexType> </xs:element> </pre>

element **cfCountry__Type/cfPers_Country/cfPersId**

diagram	
namespace	urn.xmlns:org.eurocris:cerif-1.6-2
type	cflD__Type
properties	isRef 0 content simple
facets	Kind Value annotation maxLength 128
source	<pre><xs:element name="cfPersId" type="cflD__Type"/></pre>

element **cfCountry__Type/cfCountry_Class**

diagram	
namespace	urn.xmlns:org.eurocris:cerif-1.6-2
type	cfCoreClassWithFraction__Type
properties	isRef 0 content complex
children	cfClassId cfClassSchemeld cfStartDate cfEndDate cfFraction
source	<pre><xs:element name="cfCountry_Class" type="cfCoreClassWithFraction__Type"/></pre>

element **cfCountry__Type/cfFedId**

diagram	
namespace	urn:xmlns:org:eurocris:cerif-1.6-2
type	cfFedId_EmbType
properties	isRef 0 content complex
children	cfFedIdId cfFedId cfClassId cfClassSchemeld cfStartDate cfEndDate cfFedId_Class
source	<code><xs:element name="cfFedId" type="cfFedId__EmbType"/></code>

complexType **cfCountry_Class__Type**

diagram	
namespace	urn:xmlns:org:eurocris:cerif-1.6-2
children	cfCountryCode cfClassId cfClassSchemeld cfStartDate cfEndDate cfFraction
used by	element CERIF/cfCountry_Class
source	<pre> <xs:complexType name="cfCountry_Class__Type"> <xs:sequence> <xs:element name="cfCountryCode" type="xs:string"/> <xs:group ref="cfCoreClassWithFraction__Group"/> </xs:sequence> </xs:complexType> </pre>

element **cfCountry_Class__Type/cfCountryCode**

diagram	
namespace	urn:xmlns:org:eurocris:cerif-1.6-2
type	xs:string
properties	isRef 0 content simple

source	<xs:element name="cfCountryCode" type="xs:string"/>
--------	---

complexType cfCountryName __Type

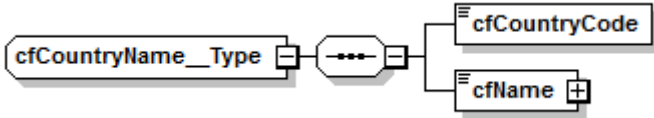
diagram	
namespace	urn:xmlns:org:eurocris:cerif-1.6-2
children	cfCountryCode cfName
used by	element CERIF/cfCountryName
source	<pre><xs:complexType name="cfCountryName__Type"> <xs:sequence> <xs:element name="cfCountryCode" type="xs:string"/> <xs:element name="cfName" type="cfMLangString__Type"/> </xs:sequence> </xs:complexType></pre>

element cfCountryName __Type/cfCountryCode

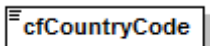
diagram	
namespace	urn:xmlns:org:eurocris:cerif-1.6-2
type	xs:string
properties	isRef 0 content simple
source	<xs:element name="cfCountryCode" type="xs:string"/>

element cfCountryName __Type/cfName

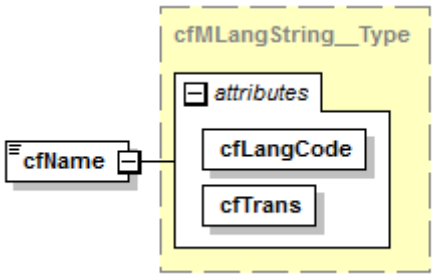
diagram																			
namespace	urn:xmlns:org:eurocris:cerif-1.6-2																		
type	cfMLangString __Type																		
properties	isRef 0 content complex																		
attributes	<table border="1"> <thead> <tr> <th>Name</th> <th>Type</th> <th>Use</th> <th>Default</th> <th>Fixed</th> <th>annotation</th> </tr> </thead> <tbody> <tr> <td>cfLangCode</td> <td>xs:string</td> <td>required</td> <td></td> <td></td> <td></td> </tr> <tr> <td>cfTrans</td> <td>cfTrans __Type</td> <td>required</td> <td></td> <td></td> <td></td> </tr> </tbody> </table>	Name	Type	Use	Default	Fixed	annotation	cfLangCode	xs:string	required				cfTrans	cfTrans __Type	required			
Name	Type	Use	Default	Fixed	annotation														
cfLangCode	xs:string	required																	
cfTrans	cfTrans __Type	required																	
source	<xs:element name="cfName" type="cfMLangString__Type"/>																		

complexType **cfCurrency__Type**

diagram	
namespace	urn:xmlns:org:eurocris:cerif-1.6-2
children	cfCurrCode cfNumCurrCode cfURI cfName cfEntName cfCurrency_Class cfFedId
used by	element CERIF/cfCurrency
source	<pre> <xs:complexType name="cfCurrency__Type"> <xs:sequence> <xs:element name="cfCurrCode" type="xs:string"/> <xs:element name="cfNumCurrCode" type="xs:string" minOccurs="0"/> <xs:element name="cfURI" type="xs:string" minOccurs="0"/> <xs:choice minOccurs="0" maxOccurs="unbounded"> <!-- embedded multiple-language attributes --> <xs:element name="cfName" type="cfMLangString__Type"/> <xs:element name="cfEntName" type="cfMLangString__Type"/> <xs:element name="cfCurrency_Class" type="cfCoreClassWithFraction__Type"/> <!-- embedded federated identifiers --> <xs:element name="cfFedId" type="cfFedId__EmbType"/> </xs:choice> </xs:sequence> </xs:complexType> </pre>

element **cfCurrency__Type/cfCurrCode**

diagram	
namespace	urn:xmlns:org:eurocris:cerif-1.6-2
type	xs:string
properties	isRef 0 content simple
source	<pre><xs:element name="cfCurrCode" type="xs:string"/></pre>

element **cfCurrency__Type/cfNumCurrCode**

diagram	
namespace	urn:xmlns:org:eurocris:cerif-1.6-2
type	xs:string
properties	isRef 0 minOcc 0 maxOcc 1 content simple
source	<pre><xs:element name="cfNumCurrCode" type="xs:string" minOccurs="0"/></pre>

element **cfCurrency__Type/cfURI**

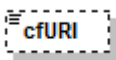
diagram	
namespace	urn:xmlns:org:eurocris:cerif-1.6-2
type	xs:string
properties	isRef 0 minOcc 0 maxOcc 1 content simple
source	<code><xs:element name="cfURI" type="xs:string" minOccurs="0"/></code>

element **cfCurrency__Type/cfName**

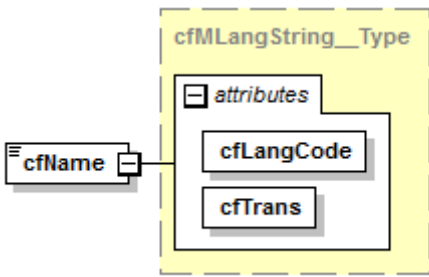
diagram																			
namespace	urn:xmlns:org:eurocris:cerif-1.6-2																		
type	cfMLangString__Type																		
properties	isRef 0 content complex																		
attributes	<table border="1"> <thead> <tr> <th>Name</th> <th>Type</th> <th>Use</th> <th>Default</th> <th>Fixed</th> <th>annotation</th> </tr> </thead> <tbody> <tr> <td>cfLangCode</td> <td>xs:string</td> <td>required</td> <td></td> <td></td> <td></td> </tr> <tr> <td>cfTrans</td> <td>cfTrans__Type</td> <td>required</td> <td></td> <td></td> <td></td> </tr> </tbody> </table>	Name	Type	Use	Default	Fixed	annotation	cfLangCode	xs:string	required				cfTrans	cfTrans__Type	required			
Name	Type	Use	Default	Fixed	annotation														
cfLangCode	xs:string	required																	
cfTrans	cfTrans__Type	required																	
source	<code><xs:element name="cfName" type="cfMLangString__Type"/></code>																		

element **cfCurrency__Type/cfEntName**

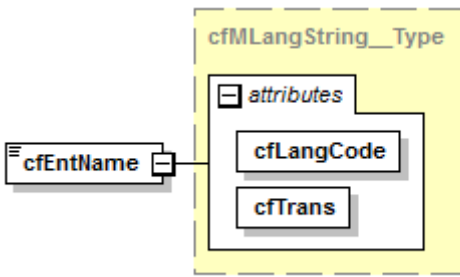
diagram																			
namespace	urn:xmlns:org:eurocris:cerif-1.6-2																		
type	cfMLangString__Type																		
properties	isRef 0 content complex																		
attributes	<table border="1"> <thead> <tr> <th>Name</th> <th>Type</th> <th>Use</th> <th>Default</th> <th>Fixed</th> <th>annotation</th> </tr> </thead> <tbody> <tr> <td>cfLangCode</td> <td>xs:string</td> <td>required</td> <td></td> <td></td> <td></td> </tr> <tr> <td>cfTrans</td> <td>cfTrans__Type</td> <td>required</td> <td></td> <td></td> <td></td> </tr> </tbody> </table>	Name	Type	Use	Default	Fixed	annotation	cfLangCode	xs:string	required				cfTrans	cfTrans__Type	required			
Name	Type	Use	Default	Fixed	annotation														
cfLangCode	xs:string	required																	
cfTrans	cfTrans__Type	required																	
source	<code><xs:element name="cfEntName" type="cfMLangString__Type"/></code>																		

element **cfCurrency__Type/cfCurrency_Class**

diagram	
namespace	urn.xmlns:org:eurocris:cerif-1.6-2
type	cfCoreClassWithFraction_Type
properties	isRef 0 content complex
children	cfClassId cfClassSchemeld cfStartDate cfEndDate cfFraction
source	<code><xs:element name="cfCurrency_Class" type="cfCoreClassWithFraction__Type"/></code>

element **cfCurrency__Type/cfFedId**

diagram	
namespace	urn.xmlns:org:eurocris:cerif-1.6-2
type	cfFedId_EmbType
properties	isRef 0 content complex
children	cfFedIdId cfFedId cfClassId cfClassSchemeld cfStartDate cfEndDate cfFedId_Class
source	<code><xs:element name="cfFedId" type="cfFedId__EmbType"/></code>

complexType **cfCurrency_Class__Type**

diagram	
---------	--

namespace	urn:xmlns:org:eurocris:cerif-1.6-2
children	cfCurrCode cfClassId cfClassSchemeld cfStartDate cfEndDate cfFraction
used by	element CERIF/cfCurrency_Class
source	<pre><xs:complexType name="cfCurrency_Class__Type"> <xs:sequence> <xs:element name="cfCurrCode" type="xs:string"/> <xs:group ref="cfCoreClassWithFraction__Group"/> </xs:sequence> </xs:complexType></pre>

element cfCurrency_Class__Type/cfCurrCode

diagram	
namespace	urn:xmlns:org:eurocris:cerif-1.6-2
type	xs:string
properties	isRef 0 content simple
source	<pre><xs:element name="cfCurrCode" type="xs:string"/></pre>

complexType cfCurrencyEntName__Type

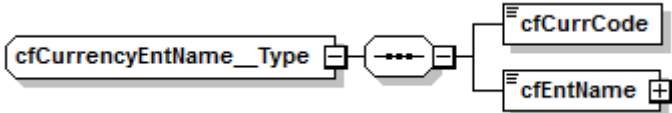
diagram	
namespace	urn:xmlns:org:eurocris:cerif-1.6-2
children	cfCurrCode cfEntName
used by	element CERIF/cfCurrencyEntName
source	<pre><xs:complexType name="cfCurrencyEntName__Type"> <xs:sequence> <xs:element name="cfCurrCode" type="xs:string"/> <xs:element name="cfEntName" type="cfMLangString__Type"/> </xs:sequence> </xs:complexType></pre>

element cfCurrencyEntName__Type/cfCurrCode

diagram	
namespace	urn:xmlns:org:eurocris:cerif-1.6-2
type	xs:string
properties	isRef 0 content simple
source	<pre><xs:element name="cfCurrCode" type="xs:string"/></pre>

element **cfCurrencyEntName__Type/cfEntName**

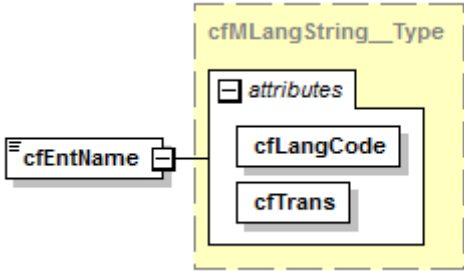
diagram																			
namespace	urn:xmlns:org:eurocris:cerif-1.6-2																		
type	cfMLangString__Type																		
properties	isRef 0 content complex																		
attributes	<table border="1"> <thead> <tr> <th>Name</th> <th>Type</th> <th>Use</th> <th>Default</th> <th>Fixed</th> <th>annotation</th> </tr> </thead> <tbody> <tr> <td>cfLangCode</td> <td>xs:string</td> <td>required</td> <td></td> <td></td> <td></td> </tr> <tr> <td>cfTrans</td> <td>cfTrans__Type</td> <td>required</td> <td></td> <td></td> <td></td> </tr> </tbody> </table>	Name	Type	Use	Default	Fixed	annotation	cfLangCode	xs:string	required				cfTrans	cfTrans__Type	required			
Name	Type	Use	Default	Fixed	annotation														
cfLangCode	xs:string	required																	
cfTrans	cfTrans__Type	required																	
source	<code><xs:element name="cfEntName" type="cfMLangString__Type"/></code>																		

complexType **cfCurrencyName__Type**

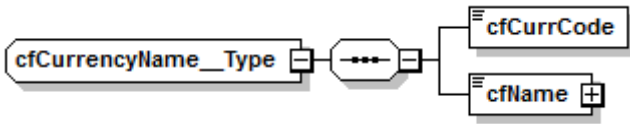
diagram	
namespace	urn:xmlns:org:eurocris:cerif-1.6-2
children	cfCurrCode cfName
used by	element CERIF/cfCurrencyName
source	<pre> <xs:complexType name="cfCurrencyName__Type"> <xs:sequence> <xs:element name="cfCurrCode" type="xs:string"/> <xs:element name="cfName" type="cfMLangString__Type"/> </xs:sequence> </xs:complexType> </pre>

element **cfCurrencyName__Type/cfCurrCode**

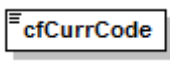
diagram	
namespace	urn:xmlns:org:eurocris:cerif-1.6-2
type	xs:string
properties	isRef 0 content simple
source	<code><xs:element name="cfCurrCode" type="xs:string"/></code>

element cfCurrencyName__Type/cfName

diagram																			
namespace	urn.xmlns:org:eurocris:cerif-1.6-2																		
type	cfMLangString__Type																		
properties	isRef 0 content complex																		
attributes	<table border="1"> <thead> <tr> <th>Name</th> <th>Type</th> <th>Use</th> <th>Default</th> <th>Fixed</th> <th>annotation</th> </tr> </thead> <tbody> <tr> <td>cfLangCode</td> <td>xs:string</td> <td>required</td> <td></td> <td></td> <td></td> </tr> <tr> <td>cfTrans</td> <td>cfTrans__Type</td> <td>required</td> <td></td> <td></td> <td></td> </tr> </tbody> </table>	Name	Type	Use	Default	Fixed	annotation	cfLangCode	xs:string	required				cfTrans	cfTrans__Type	required			
Name	Type	Use	Default	Fixed	annotation														
cfLangCode	xs:string	required																	
cfTrans	cfTrans__Type	required																	
source	<xs:element name="cfName" type="cfMLangString__Type"/>																		

complexType cfCV__Type

diagram	
namespace	urn.xmlns:org:eurocris:cerif-1.6-2
children	cfCVId cfCVDoc cfURI cfPers_CV cfCV_Class cfFedId
source	<pre> <xs:complexType name="cfCV__Type"> <xs:sequence> <xs:element name="cfCVId" type="cfId__Type"/> <xs:element name="cfCVDoc" type="xs:string" minOccurs="0"/> <xs:element name="cfURI" type="xs:string" minOccurs="0"/> <xs:choice minOccurs="0" maxOccurs="unbounded"> <!-- embedded linking entities --> <xs:element name="cfPers_CV"> <xs:complexType> <xs:sequence> <xs:element name="cfPersId" type="cfId__Type"/> <xs:group ref="cfCoreClassWithFraction__Group"/> </xs:sequence> </xs:complexType> </xs:element> <xs:element name="cfCV_Class" type="cfCoreClassWithFraction__Type"/> <!-- embedded federated identifiers --> <xs:element name="cfFedId" type="cfFedId__EmbType"/> </xs:choice> </xs:sequence> </xs:complexType> </pre>

element **cfCV__Type/cfCVId**

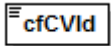
diagram	
namespace	urn.xmlns.org:eurocris:cerif-1.6-2
type	cfd__Type
properties	isRef 0 content simple
facets	Kind Value annotation maxLength 128
source	<code><xs:element name="cfCVId" type="cfd__Type"/></code>

element **cfCV__Type/cfCVDoc**

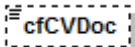
diagram	
namespace	urn.xmlns.org:eurocris:cerif-1.6-2
type	xs:string
properties	isRef 0 minOcc 0 maxOcc 1 content simple
source	<code><xs:element name="cfCVDoc" type="xs:string" minOccurs="0"/></code>

element **cfCV__Type/cfURI**

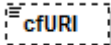
diagram	
namespace	urn.xmlns.org:eurocris:cerif-1.6-2
type	xs:string
properties	isRef 0 minOcc 0 maxOcc 1 content simple
source	<code><xs:element name="cfURI" type="xs:string" minOccurs="0"/></code>

element **cfCV__Type/cfPers_CV**

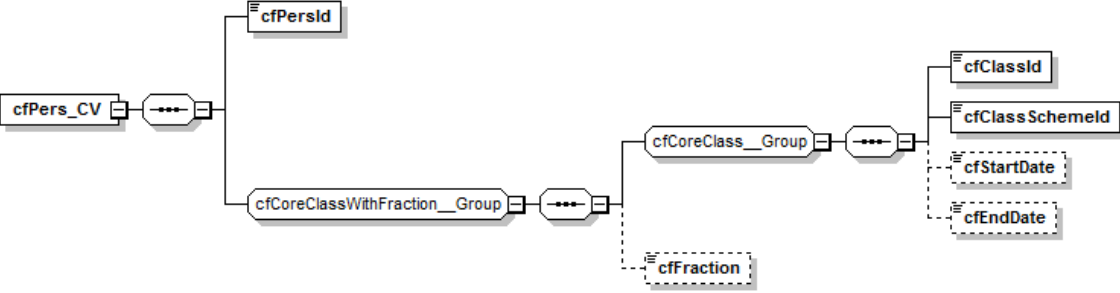
diagram	
namespace	urn.xmlns.org:eurocris:cerif-1.6-2
properties	isRef 0 content complex
children	cfPersId cfClassId cfClassSchemeld cfStartDate cfEndDate cfFraction
source	<code><xs:element name="cfPers_CV"> <xs:complexType> <xs:sequence> <xs:element name="cfPersId" type="cfd__Type"/> <xs:group ref="cfCoreClassWithFraction__Group"/></code>

	<pre> </xs:sequence> </xs:complexType> </xs:element> </pre>
--	---

element cfCV__Type/cfPers_CV/cfPersId

diagram	
namespace	urn:xmlns:org:eurocris:cerif-1.6-2
type	cfdl__Type
properties	isRef 0 content simple
facets	Kind Value annotation maxLength 128
source	<code><xs:element name="cfPersId" type="cfdl__Type"/></code>

element cfCV__Type/cfCV_Class

diagram	
namespace	urn:xmlns:org:eurocris:cerif-1.6-2
type	cfCoreClassWithFraction__Type
properties	isRef 0 content complex
children	cfClassId cfClassSchemeld cfStartDate cfEndDate cfFraction
source	<code><xs:element name="cfCV_Class" type="cfCoreClassWithFraction__Type"/></code>

element cfCV__Type/cfFedId

diagram	
namespace	urn:xmlns:org:eurocris:cerif-1.6-2

type	cfFedId_EmbType
properties	isRef 0 content complex
children	cfFedIdId cfFedId cfClassId cfClassSchemeId cfStartDate cfEndDate cfFedId_Class
source	<code><xs:element name="cfFedId" type="cfFedId_EmbType"/></code>

complexType [cfCV_Class_Type](#)

diagram	
namespace	urn:xmlns:org:eurocris:cerif-1.6-2
children	cfCVId cfClassId cfClassSchemeId cfStartDate cfEndDate cfFraction
source	<pre> <xs:complexType name="cfCV_Class_Type"> <xs:sequence> <xs:element name="cfCVId" type="cfId_Type"/> <xs:group ref="cfCoreClassWithFraction_Group"/> </xs:sequence> </xs:complexType> </pre>

element [cfCV_Class_Type/cfCVId](#)

diagram	
namespace	urn:xmlns:org:eurocris:cerif-1.6-2
type	cfId_Type
properties	isRef 0 content simple
facets	Kind Value annotation maxLength 128
source	<code><xs:element name="cfCVId" type="cfId_Type"/></code>

complexType cfDC__Type

<p>diagram</p>	
<p>namespace</p>	<p>urn:xmlns:org:eurocris:cerif-1.6-2</p>
<p>children</p>	<p>cfDCId cfDCScheme cfDCSchemeURI cfOrgUnit_DC cfPers_DC cfProj_DC cfResPubl_DC cfFedId</p>
<p>used by</p>	<p>element CERIF/cfDC</p>
<p>source</p>	<pre> <xs:complexType name="cfDC__Type"> <xs:sequence> <xs:element name="cfDCId" type="xs:string"/> <xs:element name="cfDCScheme" type="xs:string"/> <xs:element name="cfDCSchemeURI" type="xs:string" minOccurs="0"/> <xs:choice minOccurs="0" maxOccurs="unbounded"> <!-- embedded linking entities --> <xs:element name="cfOrgUnit_DC"> <xs:complexType> <xs:sequence> <xs:element name="cfOrgUnitId" type="cfId__Type"/> <xs:group ref="cfCoreClassWithFraction__Group"/> </xs:sequence> </xs:complexType> </xs:element> <xs:element name="cfPers_DC"> <xs:complexType> <xs:sequence> <xs:element name="cfPersId" type="cfId__Type"/> <xs:group ref="cfCoreClassWithFraction__Group"/> </xs:sequence> </xs:complexType> </xs:element> <xs:element name="cfProj_DC"> <xs:complexType> <xs:sequence> <xs:element name="cfProjId" type="cfId__Type"/> <xs:group ref="cfCoreClassWithFraction__Group"/> </xs:sequence> </xs:complexType> </xs:element> <xs:element name="cfResPubl_DC"> <xs:complexType> <xs:sequence> <xs:element name="cfResPublId" type="cfId__Type"/> <xs:group ref="cfCoreClassWithFraction__Group"/> </xs:sequence> </xs:complexType> </xs:element> </xs:choice> </xs:sequence> </xs:complexType> </pre>

	<pre> </xs:element> <!-- embedded federated identifiers --> <xs:element name="cfFedId" type="cfFedId__EmbType"/> </xs:choice> </xs:sequence> </xs:complexType> </pre>
--	---

element cfDC__Type/cfDCId

diagram	
namespace	urn:xmlns:org:eurocris:cerif-1.6-2
type	xs:string
properties	isRef 0 content simple
source	<code><xs:element name="cfDCId" type="xs:string"/></code>

element cfDC__Type/cfDCScheme

diagram	
namespace	urn:xmlns:org:eurocris:cerif-1.6-2
type	xs:string
properties	isRef 0 content simple
source	<code><xs:element name="cfDCScheme" type="xs:string"/></code>

element cfDC__Type/cfDCSchemeURI

diagram	
namespace	urn:xmlns:org:eurocris:cerif-1.6-2
type	xs:string
properties	isRef 0 minOcc 0 maxOcc 1 content simple
source	<code><xs:element name="cfDCSchemeURI" type="xs:string" minOccurs="0"/></code>

element cfDC__Type/cfOrgUnit_DC

diagram	
namespace	urn:xmlns:org:eurocris:cerif-1.6-2
properties	isRef 0 content complex
children	cfOrgUnitId cfClassId cfClassSchemeId cfStartDate cfEndDate cfFraction
source	<code><xs:element name="cfOrgUnit_DC"></code> <code><xs:complexType></code>

	<pre> <xs:sequence> <xs:element name="cfOrgUnitId" type="cfld__Type"/> <xs:group ref="cfCoreClassWithFraction__Group"/> </xs:sequence> </xs:complexType> </xs:element> </pre>
--	---

element cfDC__Type/cfOrgUnit_DC/cfOrgUnitId

diagram	
namespace	urn:xmlns:org:eurocris:cerif-1.6-2
type	cfld__Type
properties	isRef 0 content simple
facets	Kind Value annotation maxLength 128
source	<pre><xs:element name="cfOrgUnitId" type="cfld__Type"/></pre>

element cfDC__Type/cfPers_DC

diagram	
namespace	urn:xmlns:org:eurocris:cerif-1.6-2
properties	isRef 0 content complex
children	cfPersId cfClassId cfClassSchemeld cfStartDate cfEndDate cfFraction
source	<pre> <xs:element name="cfPers_DC"> <xs:complexType> <xs:sequence> <xs:element name="cfPersId" type="cfld__Type"/> <xs:group ref="cfCoreClassWithFraction__Group"/> </xs:sequence> </xs:complexType> </xs:element> </pre>

element cfDC__Type/cfPers_DC/cfPersId

diagram	
namespace	urn:xmlns:org:eurocris:cerif-1.6-2
type	cfld__Type
properties	isRef 0 content simple
facets	Kind Value annotation maxLength 128
source	<pre><xs:element name="cfPersId" type="cfld__Type"/></pre>

element cfDC_Type/cfProj_DC

diagram	
namespace	urn:xmlns:org:eurocris:cerif-1.6-2
properties	isRef 0 content complex
children	cfProjId cfClassId cfClassSchemeld cfStartDate cfEndDate cfFraction
source	<pre><xs:element name="cfProj_DC"> <xs:complexType> <xs:sequence> <xs:element name="cfProjId" type="cfId__Type"/> <xs:group ref="cfCoreClassWithFraction__Group"/> </xs:sequence> </xs:complexType> </xs:element></pre>

element cfDC_Type/cfProj_DC/cfProjId

diagram	
namespace	urn:xmlns:org:eurocris:cerif-1.6-2
type	cfId__Type
properties	isRef 0 content simple
facets	Kind Value annotation maxLength 128
source	<pre><xs:element name="cfProjId" type="cfId__Type"/></pre>

element cfDC_Type/cfResPubl_DC

diagram	
namespace	urn:xmlns:org:eurocris:cerif-1.6-2
properties	isRef 0 content complex
children	cfResPublId cfClassId cfClassSchemeld cfStartDate cfEndDate cfFraction
source	<pre><xs:element name="cfResPubl_DC"> <xs:complexType> <xs:sequence> <xs:element name="cfResPublId" type="cfId__Type"/> <xs:group ref="cfCoreClassWithFraction__Group"/> </xs:sequence> </xs:complexType> </xs:element></pre>

	<pre></xs:complexType> </xs:element></pre>
--	--

element cfDC__Type/cfResPubl_DC/cfResPublId

diagram	
namespace	urn:xmlns:org:eurocris:cerif-1.6-2
type	cfId_Type
properties	isRef 0 content simple
facets	Kind Value annotation maxLength 128
source	<pre><xs:element name="cfResPublId" type="cfId_Type"/></pre>

element cfDC__Type/cfFedId

diagram	
namespace	urn:xmlns:org:eurocris:cerif-1.6-2
type	cfFedId_EmbType
properties	isRef 0 content complex
children	cfFedIdId cfFedId cfClassId cfClassSchemeld cfStartDate cfEndDate cfFedId_Class
source	<pre><xs:element name="cfFedId" type="cfFedId__EmbType"/></pre>

complexType **cfDCAudience__Type**

diagram	
namespace	urn:xmlns:org:eurocris:cerif-1.6-2
children	cfDCId cfDCScheme cfDCLangTag cfDCTrans cfDCType cfDCValue
used by	element CERIF/cfDCAudience
source	<pre><xs:complexType name="cfDCAudience__Type"> <xs:sequence> <xs:element name="cfDCId" type="xs:string"/> <xs:element name="cfDCScheme" type="xs:string"/> <xs:element name="cfDCLangTag" type="xs:string"/> <xs:element name="cfDCTrans" type="xs:string"/> <xs:element name="cfDCType" type="xs:string" minOccurs="0"/> <xs:element name="cfDCValue" type="xs:string" minOccurs="0"/> </xs:sequence> </xs:complexType></pre>

element **cfDCAudience__Type/cfDCId**

diagram	
namespace	urn:xmlns:org:eurocris:cerif-1.6-2
type	xs:string
properties	isRef 0 content simple
source	<pre><xs:element name="cfDCId" type="xs:string"/></pre>

element **cfDCAudience__Type/cfDCScheme**

diagram	
namespace	urn:xmlns:org:eurocris:cerif-1.6-2
type	xs:string
properties	isRef 0 content simple
source	<pre><xs:element name="cfDCScheme" type="xs:string"/></pre>

element **cfDCAudience__Type/cfDCLangTag**

diagram	
namespace	urn:xmlns:org:eurocris:cerif-1.6-2
type	xs:string

properties	isRef 0 content simple
source	<xs:element name="cfDCLangTag" type="xs:string"/>

element cfDCAudience__Type/cfDCTrans

diagram	
namespace	urn:xmlns:org:eurocris:cerif-1.6-2
type	xs:string
properties	isRef 0 content simple
source	<xs:element name="cfDCTrans" type="xs:string"/>

element cfDCAudience__Type/cfDCType

diagram	
namespace	urn:xmlns:org:eurocris:cerif-1.6-2
type	xs:string
properties	isRef 0 minOcc 0 maxOcc 1 content simple
source	<xs:element name="cfDCType" type="xs:string" minOccurs="0"/>

element cfDCAudience__Type/cfDCValue

diagram	
namespace	urn:xmlns:org:eurocris:cerif-1.6-2
type	xs:string
properties	isRef 0 minOcc 0 maxOcc 1 content simple
source	<xs:element name="cfDCValue" type="xs:string" minOccurs="0"/>

complexType cfDCContributor__Type

diagram	
namespace	urn:xmlns:org:eurocris:cerif-1.6-2
children	cfDCId cfDCScheme cfDCLangTag cfDCTrans cfDCType cfDCValue
used by	element CERIF/cfDCContributor

source	<pre><xs:complexType name="cfDCContributor__Type"> <xs:sequence> <xs:element name="cfDCId" type="xs:string"/> <xs:element name="cfDCScheme" type="xs:string"/> <xs:element name="cfDCLangTag" type="xs:string"/> <xs:element name="cfDCTrans" type="xs:string"/> <xs:element name="cfDCType" type="xs:string" minOccurs="0"/> <xs:element name="cfDCValue" type="xs:string" minOccurs="0"/> </xs:sequence> </xs:complexType></pre>
--------	--

element cfDCContributor__Type/cfDCId

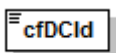
diagram	
namespace	urn:xmlns:org:eurocris:cerif-1.6-2
type	xs:string
properties	isRef 0 content simple
source	<pre><xs:element name="cfDCId" type="xs:string"/></pre>

element cfDCContributor__Type/cfDCScheme

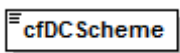
diagram	
namespace	urn:xmlns:org:eurocris:cerif-1.6-2
type	xs:string
properties	isRef 0 content simple
source	<pre><xs:element name="cfDCScheme" type="xs:string"/></pre>

element cfDCContributor__Type/cfDCLangTag

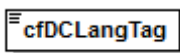
diagram	
namespace	urn:xmlns:org:eurocris:cerif-1.6-2
type	xs:string
properties	isRef 0 content simple
source	<pre><xs:element name="cfDCLangTag" type="xs:string"/></pre>

element cfDCContributor__Type/cfDCTrans

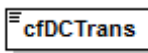
diagram	
namespace	urn:xmlns:org:eurocris:cerif-1.6-2
type	xs:string
properties	isRef 0 content simple
source	<pre><xs:element name="cfDCTrans" type="xs:string"/></pre>

element **cfDCContributor__Type/cfDCType**

diagram	
namespace	urn:xmlns:org:eurocris:cerif-1.6-2
type	xs:string
properties	isRef 0 minOcc 0 maxOcc 1 content simple
source	<code><xs:element name="cfDCType" type="xs:string" minOccurs="0"/></code>

element **cfDCContributor__Type/cfDCValue**

diagram	
namespace	urn:xmlns:org:eurocris:cerif-1.6-2
type	xs:string
properties	isRef 0 minOcc 0 maxOcc 1 content simple
source	<code><xs:element name="cfDCValue" type="xs:string" minOccurs="0"/></code>

complexType **cfDCCoverage__Type**

diagram	
namespace	urn:xmlns:org:eurocris:cerif-1.6-2
children	cfDCId cfDCScheme cfDCTrans cfDCLangTag cfDCType cfDCValue
used by	element CERIF/cfDCCoverage
source	<pre><xs:complexType name="cfDCCoverage__Type"> <xs:sequence> <xs:element name="cfDCId" type="xs:string"/> <xs:element name="cfDCScheme" type="xs:string"/> <xs:element name="cfDCTrans" type="xs:string"/> <xs:element name="cfDCLangTag" type="xs:string"/> <xs:element name="cfDCType" type="xs:string" minOccurs="0"/> <xs:element name="cfDCValue" type="xs:string" minOccurs="0"/> </xs:sequence> </xs:complexType></pre>

element **cfDCCoverage__Type/cfDCId**

diagram	
---------	--

namespace	urn:xmlns:org:eurocris:cerif-1.6-2
type	xs:string
properties	isRef 0 content simple
source	<code><xs:element name="cfDCId" type="xs:string"/></code>

element cfDCCoverage__Type/cfDCScheme

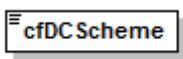
diagram	
namespace	urn:xmlns:org:eurocris:cerif-1.6-2
type	xs:string
properties	isRef 0 content simple
source	<code><xs:element name="cfDCScheme" type="xs:string"/></code>

element cfDCCoverage__Type/cfDCTrans

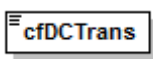
diagram	
namespace	urn:xmlns:org:eurocris:cerif-1.6-2
type	xs:string
properties	isRef 0 content simple
source	<code><xs:element name="cfDCTrans" type="xs:string"/></code>

element cfDCCoverage__Type/cfDCLangTag

diagram	
namespace	urn:xmlns:org:eurocris:cerif-1.6-2
type	xs:string
properties	isRef 0 content simple
source	<code><xs:element name="cfDCLangTag" type="xs:string"/></code>

element cfDCCoverage__Type/cfDCType

diagram	
namespace	urn:xmlns:org:eurocris:cerif-1.6-2
type	xs:string
properties	isRef 0 minOcc 0 maxOcc 1 content simple
source	<code><xs:element name="cfDCType" type="xs:string" minOccurs="0"/></code>

element cfDCCoverage__Type/cfDCValue

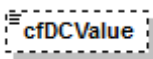
diagram	
namespace	urn:xmlns:org:eurocris:cerif-1.6-2
type	xs:string

properties	isRef 0 minOcc 0 maxOcc 1 content simple
source	<xs:element name="cfDCValue" type="xs:string" minOccurs="0"/>

complexType cfDCCoverageSpatial__Type

diagram	
namespace	urn.xmlns:org:eurocris:cerif-1.6-2
children	cfDCId cfDCScheme cfDCLangTag cfDCTrans cfDCValue cfFDCXCoordinate cfFDCYCoordinate cfFDCZCoordinate cfFDCPrecision
used by	element CERIF/cfDCCoverageSpatial
source	<pre><xs:complexType name="cfDCCoverageSpatial__Type"> <xs:sequence> <xs:element name="cfDCId" type="xs:string"/> <xs:element name="cfDCScheme" type="xs:string"/> <xs:element name="cfDCLangTag" type="xs:string"/> <xs:element name="cfDCTrans" type="xs:string"/> <xs:element name="cfDCValue" type="xs:string" minOccurs="0"/> <xs:element name="cfFDCXCoordinate" type="xs:string" minOccurs="0"/> <xs:element name="cfFDCYCoordinate" type="xs:string" minOccurs="0"/> <xs:element name="cfFDCZCoordinate" type="xs:string" minOccurs="0"/> <xs:element name="cfFDCPrecision" type="xs:string" minOccurs="0"/> </xs:sequence> </xs:complexType></pre>

element cfDCCoverageSpatial__Type/cfDCId

diagram	
namespace	urn.xmlns:org:eurocris:cerif-1.6-2
type	xs:string
properties	isRef 0 content simple
source	<xs:element name="cfDCId" type="xs:string"/>

element **cfDCCoverageSpatial__Type/cfDCScheme**

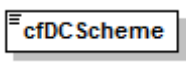
diagram	
namespace	urn:xmlns:org:eurocris:cerif-1.6-2
type	xs:string
properties	isRef 0 content simple
source	<code><xs:element name="cfDCScheme" type="xs:string"/></code>

element **cfDCCoverageSpatial__Type/cfDCLangTag**

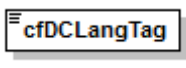
diagram	
namespace	urn:xmlns:org:eurocris:cerif-1.6-2
type	xs:string
properties	isRef 0 content simple
source	<code><xs:element name="cfDCLangTag" type="xs:string"/></code>

element **cfDCCoverageSpatial__Type/cfDCTrans**

diagram	
namespace	urn:xmlns:org:eurocris:cerif-1.6-2
type	xs:string
properties	isRef 0 content simple
source	<code><xs:element name="cfDCTrans" type="xs:string"/></code>

element **cfDCCoverageSpatial__Type/cfDCValue**

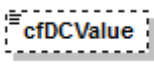
diagram	
namespace	urn:xmlns:org:eurocris:cerif-1.6-2
type	xs:string
properties	isRef 0 minOcc 0 maxOcc 1 content simple
source	<code><xs:element name="cfDCValue" type="xs:string" minOccurs="0"/></code>

element **cfDCCoverageSpatial__Type/cfFDCXCoordinate**

diagram	
namespace	urn:xmlns:org:eurocris:cerif-1.6-2
type	xs:string
properties	isRef 0 minOcc 0 maxOcc 1 content simple
source	<code><xs:element name="cfFDCXCoordinate" type="xs:string" minOccurs="0"/></code>

element **cfDCCoverageSpatial__Type/cfFDCYCoordinate**

diagram	
namespace	urn:xmlns:org:eurocris:cerif-1.6-2
type	xs:string
properties	isRef 0 minOcc 0 maxOcc 1 content simple
source	<code><xs:element name="cfFDCYCoordinate" type="xs:string" minOccurs="0"/></code>

element **cfDCCoverageSpatial__Type/cfFDCZCoordinate**

diagram	
namespace	urn:xmlns:org:eurocris:cerif-1.6-2
type	xs:string
properties	isRef 0 minOcc 0 maxOcc 1 content simple
source	<code><xs:element name="cfFDCZCoordinate" type="xs:string" minOccurs="0"/></code>

element **cfDCCoverageSpatial__Type/cfFDCPrecision**

diagram	
namespace	urn:xmlns:org:eurocris:cerif-1.6-2
type	xs:string
properties	isRef 0 minOcc 0 maxOcc 1 content simple
source	<code><xs:element name="cfFDCPrecision" type="xs:string" minOccurs="0"/></code>

complexType **cfDCCoverageTemporal__Type**

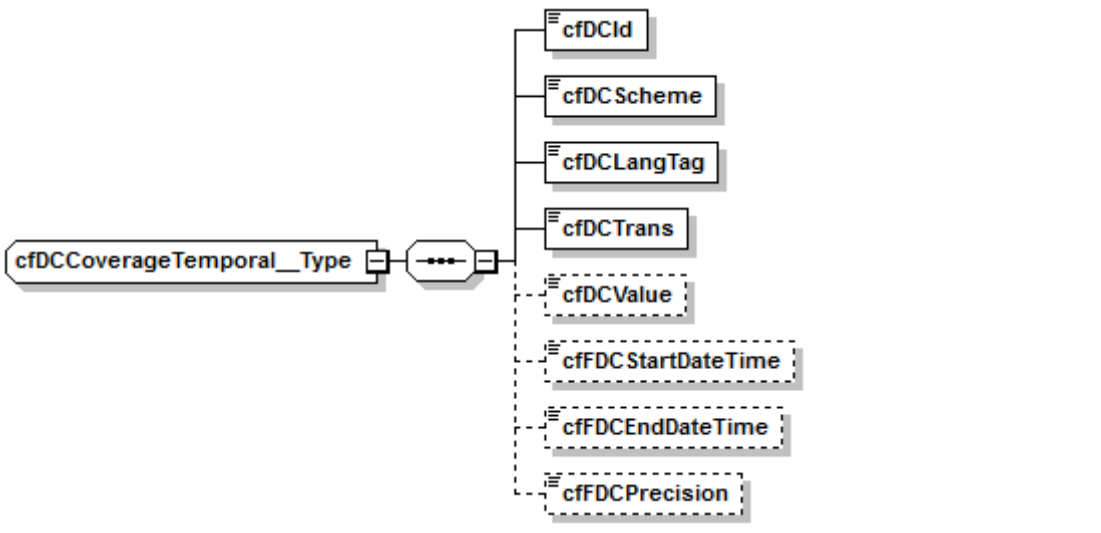
diagram	
namespace	urn:xmlns:org:eurocris:cerif-1.6-2
children	cfDCId cfDCScheme cfDCLangTag cfDCTrans cfDCValue cfFDCStartDateTime cfFDCEndDateTime cfFDCPrecision

used by	element CERIF/cfDCCoverageTemporal
source	<pre><xs:complexType name="cfDCCoverageTemporal__Type"> <xs:sequence> <xs:element name="cfDCId" type="xs:string"/> <xs:element name="cfDCScheme" type="xs:string"/> <xs:element name="cfDCLangTag" type="xs:string"/> <xs:element name="cfDCTrans" type="xs:string"/> <xs:element name="cfDCValue" type="xs:string" minOccurs="0"/> <xs:element name="cfFDCStartDateTime" type="xs:dateTime" minOccurs="0"/> <xs:element name="cfFDCEndDateTime" type="xs:dateTime" minOccurs="0"/> <xs:element name="cfFDCPrecision" type="xs:string" minOccurs="0"/> </xs:sequence> </xs:complexType></pre>

element cfDCCoverageTemporal__Type/cfDCId

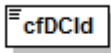
diagram	
namespace	urn:xmlns:org:eurocris:cerif-1.6-2
type	xs:string
properties	isRef 0 content simple
source	<pre><xs:element name="cfDCId" type="xs:string"/></pre>

element cfDCCoverageTemporal__Type/cfDCScheme

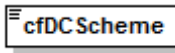
diagram	
namespace	urn:xmlns:org:eurocris:cerif-1.6-2
type	xs:string
properties	isRef 0 content simple
source	<pre><xs:element name="cfDCScheme" type="xs:string"/></pre>

element cfDCCoverageTemporal__Type/cfDCLangTag

diagram	
namespace	urn:xmlns:org:eurocris:cerif-1.6-2
type	xs:string
properties	isRef 0 content simple
source	<pre><xs:element name="cfDCLangTag" type="xs:string"/></pre>

element cfDCCoverageTemporal__Type/cfDCTrans

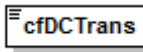
diagram	
namespace	urn:xmlns:org:eurocris:cerif-1.6-2
type	xs:string
properties	isRef 0 content simple
source	<pre><xs:element name="cfDCTrans" type="xs:string"/></pre>

element **cfDCCoverageTemporal__Type/cfDCValue**

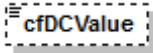
diagram	
namespace	urn:xmlns:org:eurocris:cerif-1.6-2
type	xs:string
properties	isRef 0 minOcc 0 maxOcc 1 content simple
source	<code><xs:element name="cfDCValue" type="xs:string" minOccurs="0"/></code>

element **cfDCCoverageTemporal__Type/cfDCStartDateTime**

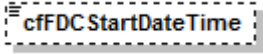
diagram	
namespace	urn:xmlns:org:eurocris:cerif-1.6-2
type	xs:dateTime
properties	isRef 0 minOcc 0 maxOcc 1 content simple
source	<code><xs:element name="cfDCStartDateTime" type="xs:dateTime" minOccurs="0"/></code>

element **cfDCCoverageTemporal__Type/cfDCEndTimeTime**

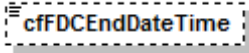
diagram	
namespace	urn:xmlns:org:eurocris:cerif-1.6-2
type	xs:dateTime
properties	isRef 0 minOcc 0 maxOcc 1 content simple
source	<code><xs:element name="cfDCEndTimeTime" type="xs:dateTime" minOccurs="0"/></code>

element **cfDCCoverageTemporal__Type/cfDCPrecision**

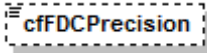
diagram	
namespace	urn:xmlns:org:eurocris:cerif-1.6-2
type	xs:string
properties	isRef 0 minOcc 0 maxOcc 1 content simple
source	<code><xs:element name="cfDCPrecision" type="xs:string" minOccurs="0"/></code>

complexType cfDCCreator__Type

diagram	
namespace	urn:xmlns:org:eurocris:cerif-1.6-2
children	cfDCId cfDCScheme cfDCLangTag cfDCTrans cfDCType cfDCValue
used by	element CERIF/cfDCCreator
source	<pre><xs:complexType name="cfDCCreator__Type"> <xs:sequence> <xs:element name="cfDCId" type="xs:string"/> <xs:element name="cfDCScheme" type="xs:string"/> <xs:element name="cfDCLangTag" type="xs:string"/> <xs:element name="cfDCTrans" type="xs:string"/> <xs:element name="cfDCType" type="xs:string" minOccurs="0"/> <xs:element name="cfDCValue" type="xs:string" minOccurs="0"/> </xs:sequence> </xs:complexType></pre>

element cfDCCreator__Type/cfDCId

diagram	
namespace	urn:xmlns:org:eurocris:cerif-1.6-2
type	xs:string
properties	isRef 0 content simple
source	<pre><xs:element name="cfDCId" type="xs:string"/></pre>

element cfDCCreator__Type/cfDCScheme

diagram	
namespace	urn:xmlns:org:eurocris:cerif-1.6-2
type	xs:string
properties	isRef 0 content simple
source	<pre><xs:element name="cfDCScheme" type="xs:string"/></pre>

element cfDCCreator__Type/cfDCLangTag

diagram	
namespace	urn:xmlns:org:eurocris:cerif-1.6-2
type	xs:string

properties	isRef 0 content simple
source	<xs:element name="cfDCLangTag" type="xs:string"/>

element cfDCCreator__Type/cfDCTrans

diagram	
namespace	urn:xmlns:org:eurocris:cerif-1.6-2
type	xs:string
properties	isRef 0 content simple
source	<xs:element name="cfDCTrans" type="xs:string"/>

element cfDCCreator__Type/cfDCType

diagram	
namespace	urn:xmlns:org:eurocris:cerif-1.6-2
type	xs:string
properties	isRef 0 minOcc 0 maxOcc 1 content simple
source	<xs:element name="cfDCType" type="xs:string" minOccurs="0"/>

element cfDCCreator__Type/cfDCValue

diagram	
namespace	urn:xmlns:org:eurocris:cerif-1.6-2
type	xs:string
properties	isRef 0 minOcc 0 maxOcc 1 content simple
source	<xs:element name="cfDCValue" type="xs:string" minOccurs="0"/>

complexType cfDCDate__Type

diagram	
---------	--

namespace	urn:xmlns:org:eurocris:cerif-1.6-2
children	cfDCId cfDCScheme cfDCLangTag cfDCTrans cfDCType cfDCValue cfDCDateBegin cfDCDateEnd
used by	element CERIF/cfDCDate
source	<pre><xs:complexType name="cfDCDate__Type"> <xs:sequence> <xs:element name="cfDCId" type="xs:string"/> <xs:element name="cfDCScheme" type="xs:string"/> <xs:element name="cfDCLangTag" type="xs:string"/> <xs:element name="cfDCTrans" type="xs:string"/> <xs:element name="cfDCType" type="xs:string" minOccurs="0"/> <xs:element name="cfDCValue" type="xs:string" minOccurs="0"/> <xs:element name="cfDCDateBegin" type="xs:dateTime" minOccurs="0"/> <xs:element name="cfDCDateEnd" type="xs:dateTime" minOccurs="0"/> </xs:sequence> </xs:complexType></pre>

element [cfDCDate__Type/cfDCId](#)

diagram	
namespace	urn:xmlns:org:eurocris:cerif-1.6-2
type	xs:string
properties	isRef 0 content simple
source	<pre><xs:element name="cfDCId" type="xs:string"/></pre>

element [cfDCDate__Type/cfDCScheme](#)

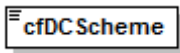
diagram	
namespace	urn:xmlns:org:eurocris:cerif-1.6-2
type	xs:string
properties	isRef 0 content simple
source	<pre><xs:element name="cfDCScheme" type="xs:string"/></pre>

element [cfDCDate__Type/cfDCLangTag](#)

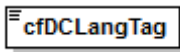
diagram	
namespace	urn:xmlns:org:eurocris:cerif-1.6-2
type	xs:string
properties	isRef 0 content simple
source	<pre><xs:element name="cfDCLangTag" type="xs:string"/></pre>

element [cfDCDate__Type/cfDCTrans](#)

diagram	
namespace	urn:xmlns:org:eurocris:cerif-1.6-2
type	xs:string
properties	isRef 0 content simple

source	<code><xs:element name="cfDCTrans" type="xs:string"/></code>
--------	--

element cfDCDate__Type/cfDCType

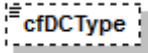
diagram	
namespace	urn:xmlns:org:eurocris:cerif-1.6-2
type	xs:string
properties	isRef 0 minOcc 0 maxOcc 1 content simple
source	<code><xs:element name="cfDCType" type="xs:string" minOccurs="0"/></code>

element cfDCDate__Type/cfDCValue

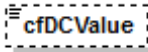
diagram	
namespace	urn:xmlns:org:eurocris:cerif-1.6-2
type	xs:string
properties	isRef 0 minOcc 0 maxOcc 1 content simple
source	<code><xs:element name="cfDCValue" type="xs:string" minOccurs="0"/></code>

element cfDCDate__Type/cfDCDateBegin

diagram	
namespace	urn:xmlns:org:eurocris:cerif-1.6-2
type	xs:dateTime
properties	isRef 0 minOcc 0 maxOcc 1 content simple
source	<code><xs:element name="cfDCDateBegin" type="xs:dateTime" minOccurs="0"/></code>

element cfDCDate__Type/cfDCDateEnd

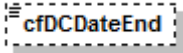
diagram	
namespace	urn:xmlns:org:eurocris:cerif-1.6-2
type	xs:dateTime
properties	isRef 0 minOcc 0 maxOcc 1 content simple
source	<code><xs:element name="cfDCDateEnd" type="xs:dateTime" minOccurs="0"/></code>

complexType cfDCDescription__Type

diagram	
namespace	urn:xmlns:org:eurocris:cerif-1.6-2
children	cfDCId cfDCScheme cfDCLangTag cfDCTrans cfDCType cfDCValue
used by	element CERIF/cfDCDescription
source	<pre><xs:complexType name="cfDCDescription__Type"> <xs:sequence> <xs:element name="cfDCId" type="xs:string"/> <xs:element name="cfDCScheme" type="xs:string"/> <xs:element name="cfDCLangTag" type="xs:string"/> <xs:element name="cfDCTrans" type="xs:string"/> <xs:element name="cfDCType" type="xs:string" minOccurs="0"/> <xs:element name="cfDCValue" type="xs:string" minOccurs="0"/> </xs:sequence> </xs:complexType></pre>

element cfDCDescription__Type/cfDCId

diagram	
namespace	urn:xmlns:org:eurocris:cerif-1.6-2
type	xs:string
properties	isRef 0 content simple
source	<pre><xs:element name="cfDCId" type="xs:string"/></pre>

element cfDCDescription__Type/cfDCScheme

diagram	
namespace	urn:xmlns:org:eurocris:cerif-1.6-2
type	xs:string
properties	isRef 0 content simple
source	<pre><xs:element name="cfDCScheme" type="xs:string"/></pre>

element cfDCDescription__Type/cfDCLangTag

diagram	
namespace	urn:xmlns:org:eurocris:cerif-1.6-2
type	xs:string

properties	isRef 0 content simple
source	<xs:element name="cfDCLangTag" type="xs:string"/>

element cfDCDescription__Type/cfDCTrans

diagram	
namespace	urn:xmlns:org:eurocris:cerif-1.6-2
type	xs:string
properties	isRef 0 content simple
source	<xs:element name="cfDCTrans" type="xs:string"/>

element cfDCDescription__Type/cfDCType

diagram	
namespace	urn:xmlns:org:eurocris:cerif-1.6-2
type	xs:string
properties	isRef 0 minOcc 0 maxOcc 1 content simple
source	<xs:element name="cfDCType" type="xs:string" minOccurs="0"/>

element cfDCDescription__Type/cfDCValue

diagram	
namespace	urn:xmlns:org:eurocris:cerif-1.6-2
type	xs:string
properties	isRef 0 minOcc 0 maxOcc 1 content simple
source	<xs:element name="cfDCValue" type="xs:string" minOccurs="0"/>

complexType cfDCFormat__Type

diagram	
namespace	urn:xmlns:org:eurocris:cerif-1.6-2
children	cfDCId cfDCScheme cfDCLangTag cfDCTrans cfDCType cfDCValue
used by	element CERIF/cfDCFormat

source	<pre><xs:complexType name="cfDCFormat__Type"> <xs:sequence> <xs:element name="cfDCId" type="xs:string"/> <xs:element name="cfDCScheme" type="xs:string"/> <xs:element name="cfDCLangTag" type="xs:string"/> <xs:element name="cfDCTrans" type="xs:string"/> <xs:element name="cfDCType" type="xs:string" minOccurs="0"/> <xs:element name="cfDCValue" type="xs:string" minOccurs="0"/> </xs:sequence> </xs:complexType></pre>
--------	---

element **cfDCFormat__Type/cfDCId**

diagram	
namespace	urn:xmlns:org:eurocris:cerif-1.6-2
type	xs:string
properties	isRef 0 content simple
source	<pre><xs:element name="cfDCId" type="xs:string"/></pre>

element **cfDCFormat__Type/cfDCScheme**

diagram	
namespace	urn:xmlns:org:eurocris:cerif-1.6-2
type	xs:string
properties	isRef 0 content simple
source	<pre><xs:element name="cfDCScheme" type="xs:string"/></pre>

element **cfDCFormat__Type/cfDCLangTag**

diagram	
namespace	urn:xmlns:org:eurocris:cerif-1.6-2
type	xs:string
properties	isRef 0 content simple
source	<pre><xs:element name="cfDCLangTag" type="xs:string"/></pre>

element **cfDCFormat__Type/cfDCTrans**

diagram	
namespace	urn:xmlns:org:eurocris:cerif-1.6-2
type	xs:string
properties	isRef 0 content simple
source	<pre><xs:element name="cfDCTrans" type="xs:string"/></pre>

element **cfDCFormat__Type/cfDCType**

diagram	
namespace	urn:xmlns:org:eurocris:cerif-1.6-2
type	xs:string
properties	isRef 0 minOcc 0 maxOcc 1 content simple
source	<code><xs:element name="cfDCType" type="xs:string" minOccurs="0"/></code>

element **cfDCFormat__Type/cfDCValue**

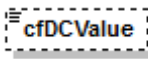
diagram	
namespace	urn:xmlns:org:eurocris:cerif-1.6-2
type	xs:string
properties	isRef 0 minOcc 0 maxOcc 1 content simple
source	<code><xs:element name="cfDCValue" type="xs:string" minOccurs="0"/></code>

complexType **cfDCLanguage__Type**

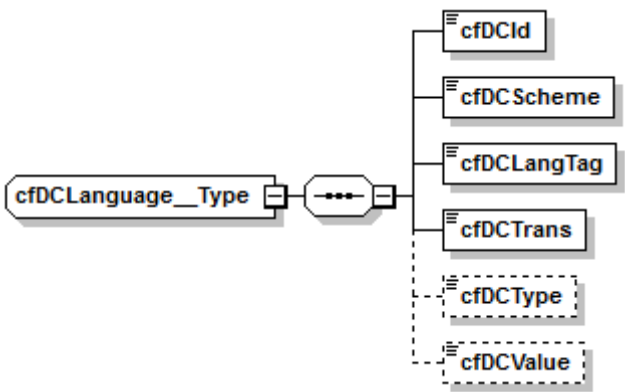
diagram	
namespace	urn:xmlns:org:eurocris:cerif-1.6-2
children	cfDCId cfDCScheme cfDCLangTag cfDCTrans cfDCType cfDCValue
used by	element CERIF/cfDCLanguage
source	<pre><xs:complexType name="cfDCLanguage__Type"> <xs:sequence> <xs:element name="cfDCId" type="xs:string"/> <xs:element name="cfDCScheme" type="xs:string"/> <xs:element name="cfDCLangTag" type="xs:string"/> <xs:element name="cfDCTrans" type="xs:string"/> <xs:element name="cfDCType" type="xs:string" minOccurs="0"/> <xs:element name="cfDCValue" type="xs:string" minOccurs="0"/> </xs:sequence> </xs:complexType></pre>

element **cfDCLanguage__Type/cfDCId**

diagram	
---------	---

namespace	urn:xmlns:org:eurocris:cerif-1.6-2
type	xs:string
properties	isRef 0 content simple
source	<code><xs:element name="cfDCId" type="xs:string"/></code>

element cfDCLanguage__Type/cfDCScheme

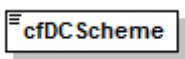
diagram	
namespace	urn:xmlns:org:eurocris:cerif-1.6-2
type	xs:string
properties	isRef 0 content simple
source	<code><xs:element name="cfDCScheme" type="xs:string"/></code>

element cfDCLanguage__Type/cfDCLangTag

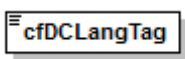
diagram	
namespace	urn:xmlns:org:eurocris:cerif-1.6-2
type	xs:string
properties	isRef 0 content simple
source	<code><xs:element name="cfDCLangTag" type="xs:string"/></code>

element cfDCLanguage__Type/cfDCTrans

diagram	
namespace	urn:xmlns:org:eurocris:cerif-1.6-2
type	xs:string
properties	isRef 0 content simple
source	<code><xs:element name="cfDCTrans" type="xs:string"/></code>

element cfDCLanguage__Type/cfDCType

diagram	
namespace	urn:xmlns:org:eurocris:cerif-1.6-2
type	xs:string
properties	isRef 0 minOcc 0 maxOcc 1 content simple
source	<code><xs:element name="cfDCType" type="xs:string" minOccurs="0"/></code>

element cfDCLanguage__Type/cfDCValue

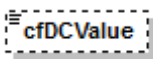
diagram	
namespace	urn:xmlns:org:eurocris:cerif-1.6-2
type	xs:string

properties	isRef 0 minOcc 0 maxOcc 1 content simple
source	<code><xs:element name="cfDCValue" type="xs:string" minOccurs="0"/></code>

complexType **cfDCProvenance__Type**

diagram	
namespace	urn:xmlns:org:eurocris:cerif-1.6-2
children	cfDCId cfDCScheme cfDCLangTag cfDCTrans cfDCType cfDCValue
used by	element CERIF/cfDCProvenance
source	<pre><xs:complexType name="cfDCProvenance__Type"> <xs:sequence> <xs:element name="cfDCId" type="xs:string"/> <xs:element name="cfDCScheme" type="xs:string"/> <xs:element name="cfDCLangTag" type="xs:string"/> <xs:element name="cfDCTrans" type="xs:string"/> <xs:element name="cfDCType" type="xs:string" minOccurs="0"/> <xs:element name="cfDCValue" type="xs:string" minOccurs="0"/> </xs:sequence> </xs:complexType></pre>

element **cfDCProvenance__Type/cfDCId**

diagram	
namespace	urn:xmlns:org:eurocris:cerif-1.6-2
type	xs:string
properties	isRef 0 content simple
source	<code><xs:element name="cfDCId" type="xs:string"/></code>

element **cfDCProvenance__Type/cfDCScheme**

diagram	
namespace	urn:xmlns:org:eurocris:cerif-1.6-2
type	xs:string
properties	isRef 0 content simple
source	<code><xs:element name="cfDCScheme" type="xs:string"/></code>

element **cfDCProvenance__Type/cfDCLangTag**

diagram	
namespace	urn:xmlns:org:eurocris:cerif-1.6-2
type	xs:string
properties	isRef 0 content simple
source	<code><xs:element name="cfDCLangTag" type="xs:string"/></code>

element **cfDCProvenance__Type/cfDCTrans**

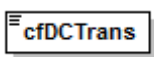
diagram	
namespace	urn:xmlns:org:eurocris:cerif-1.6-2
type	xs:string
properties	isRef 0 content simple
source	<code><xs:element name="cfDCTrans" type="xs:string"/></code>

element **cfDCProvenance__Type/cfDCType**

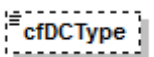
diagram	
namespace	urn:xmlns:org:eurocris:cerif-1.6-2
type	xs:string
properties	isRef 0 minOcc 0 maxOcc 1 content simple
source	<code><xs:element name="cfDCType" type="xs:string" minOccurs="0"/></code>

element **cfDCProvenance__Type/cfDCValue**

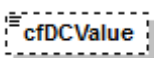
diagram	
namespace	urn:xmlns:org:eurocris:cerif-1.6-2
type	xs:string
properties	isRef 0 minOcc 0 maxOcc 1 content simple
source	<code><xs:element name="cfDCValue" type="xs:string" minOccurs="0"/></code>

complexType **cfDCPublisher__Type**

diagram	
namespace	urn:xmlns:org:eurocris:cerif-1.6-2
children	cfDCId cfDCScheme cfDCLangTag cfDCTrans cfDCType cfDCValue
used by	element CERIF/cfDCPublisher
source	<pre><xs:complexType name="cfDCPublisher__Type"> <xs:sequence> <xs:element name="cfDCId" type="xs:string"/> <xs:element name="cfDCScheme" type="xs:string"/> <xs:element name="cfDCLangTag" type="xs:string"/> <xs:element name="cfDCTrans" type="xs:string"/> <xs:element name="cfDCType" type="xs:string" minOccurs="0"/> <xs:element name="cfDCValue" type="xs:string" minOccurs="0"/> </xs:sequence> </xs:complexType></pre>

element **cfDCPublisher__Type/cfDCId**

diagram	
namespace	urn:xmlns:org:eurocris:cerif-1.6-2
type	xs:string
properties	isRef 0 content simple
source	<pre><xs:element name="cfDCId" type="xs:string"/></pre>

element **cfDCPublisher__Type/cfDCScheme**

diagram	
namespace	urn:xmlns:org:eurocris:cerif-1.6-2
type	xs:string
properties	isRef 0 content simple
source	<pre><xs:element name="cfDCScheme" type="xs:string"/></pre>

element **cfDCPublisher__Type/cfDCLangTag**

diagram	
namespace	urn:xmlns:org:eurocris:cerif-1.6-2
type	xs:string

properties	isRef 0 content simple
source	<code><xs:element name="cfDCLangTag" type="xs:string"/></code>

element cfDCPublisher__Type/cfDCTrans

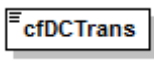
diagram	
namespace	urn:xmlns:org:eurocris:cerif-1.6-2
type	xs:string
properties	isRef 0 content simple
source	<code><xs:element name="cfDCTrans" type="xs:string"/></code>

element cfDCPublisher__Type/cfDCType

diagram	
namespace	urn:xmlns:org:eurocris:cerif-1.6-2
type	xs:string
properties	isRef 0 minOcc 0 maxOcc 1 content simple
source	<code><xs:element name="cfDCType" type="xs:string" minOccurs="0"/></code>

element cfDCPublisher__Type/cfDCValue

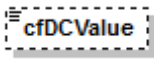
diagram	
namespace	urn:xmlns:org:eurocris:cerif-1.6-2
type	xs:string
properties	isRef 0 minOcc 0 maxOcc 1 content simple
source	<code><xs:element name="cfDCValue" type="xs:string" minOccurs="0"/></code>

complexType cfDCRelation__Type

diagram	
namespace	urn:xmlns:org:eurocris:cerif-1.6-2
children	cfDCId1 cfDCId2 cfDCScheme1 cfDCScheme2 cfDCLangTag cfDCTrans cfDCStartDate cfDCEndDate cfDCType cfDCValue
used by	element CERIF/cfDCRelation
source	<pre> <xs:complexType name="cfDCRelation__Type"> <xs:sequence> <xs:element name="cfDCId1" type="xs:string"/> <xs:element name="cfDCId2" type="xs:string"/> <xs:element name="cfDCScheme1" type="xs:string"/> <xs:element name="cfDCScheme2" type="xs:string"/> <xs:element name="cfDCLangTag" type="xs:string"/> <xs:element name="cfDCTrans" type="xs:string"/> <xs:element name="cfDCStartDate" type="xs:dateTime"/> <xs:element name="cfDCEndDate" type="xs:dateTime"/> <xs:element name="cfDCType" type="xs:string" minOccurs="0"/> <xs:element name="cfDCValue" type="xs:string" minOccurs="0"/> </xs:sequence> </xs:complexType> </pre>

element cfDCRelation__Type/cfDCId1

diagram	
namespace	urn:xmlns:org:eurocris:cerif-1.6-2
type	xs:string
properties	isRef 0 content simple
source	<pre><xs:element name="cfDCId1" type="xs:string"/></pre>

element cfDCRelation__Type/cfDCId2

diagram	
namespace	urn:xmlns:org:eurocris:cerif-1.6-2

type	xs:string
properties	isRef 0 content simple
source	<code><xs:element name="cfDCId2" type="xs:string"/></code>

element cfDCRelation__Type/cfDCScheme1

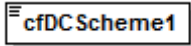
diagram	
namespace	urn:xmlns:org:eurocris:cerif-1.6-2
type	xs:string
properties	isRef 0 content simple
source	<code><xs:element name="cfDCScheme1" type="xs:string"/></code>

element cfDCRelation__Type/cfDCScheme2

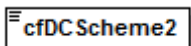
diagram	
namespace	urn:xmlns:org:eurocris:cerif-1.6-2
type	xs:string
properties	isRef 0 content simple
source	<code><xs:element name="cfDCScheme2" type="xs:string"/></code>

element cfDCRelation__Type/cfDCLangTag

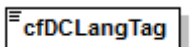
diagram	
namespace	urn:xmlns:org:eurocris:cerif-1.6-2
type	xs:string
properties	isRef 0 content simple
source	<code><xs:element name="cfDCLangTag" type="xs:string"/></code>

element cfDCRelation__Type/cfDCTrans

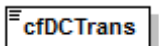
diagram	
namespace	urn:xmlns:org:eurocris:cerif-1.6-2
type	xs:string
properties	isRef 0 content simple
source	<code><xs:element name="cfDCTrans" type="xs:string"/></code>

element cfDCRelation__Type/cfDCStartDate

diagram	
namespace	urn:xmlns:org:eurocris:cerif-1.6-2
type	xs:dateTime
properties	isRef 0 content simple
source	<code><xs:element name="cfDCStartDate" type="xs:dateTime"/></code>

element **cfDCRelation__Type/cfDCEndDate**

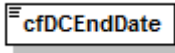
diagram	
namespace	urn:xmlns:org:eurocris:cerif-1.6-2
type	xs:dateTime
properties	isRef 0 content simple
source	<code><xs:element name="cfDCEndDate" type="xs:dateTime"/></code>

element **cfDCRelation__Type/cfDCType**

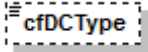
diagram	
namespace	urn:xmlns:org:eurocris:cerif-1.6-2
type	xs:string
properties	isRef 0 minOcc 0 maxOcc 1 content simple
source	<code><xs:element name="cfDCType" type="xs:string" minOccurs="0"/></code>

element **cfDCRelation__Type/cfDCValue**

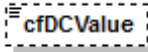
diagram	
namespace	urn:xmlns:org:eurocris:cerif-1.6-2
type	xs:string
properties	isRef 0 minOcc 0 maxOcc 1 content simple
source	<code><xs:element name="cfDCValue" type="xs:string" minOccurs="0"/></code>

complexType **cfDCResourceIdentifier__Type**

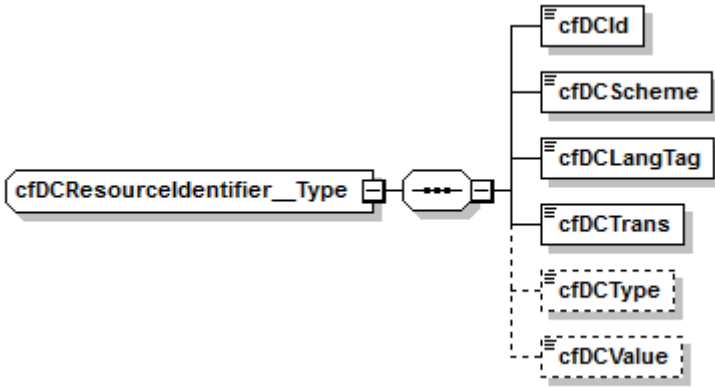
diagram	
namespace	urn:xmlns:org:eurocris:cerif-1.6-2
children	cfDCId cfDCScheme cfDCLangTag cfDCTrans cfDCType cfDCValue
used by	element CERIF/cfDCResourceIdentifier
source	<code><xs:complexType name="cfDCResourceIdentifier__Type"> <xs:sequence> <xs:element name="cfDCId" type="xs:string"/> <xs:element name="cfDCScheme" type="xs:string"/> <xs:element name="cfDCLangTag" type="xs:string"/> </xs:sequence> </xs:complexType></code>

	<pre><xs:element name="cfDCTrans" type="xs:string"/> <xs:element name="cfDCType" type="xs:string" minOccurs="0"/> <xs:element name="cfDCValue" type="xs:string" minOccurs="0"/> </xs:sequence> </xs:complexType></pre>
--	--

element cfDCResourceIdentifier__Type/cfDCId

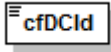
diagram	
namespace	urn:xmlns:org:eurocris:cerif-1.6-2
type	xs:string
properties	isRef 0 content simple
source	<pre><xs:element name="cfDCId" type="xs:string"/></pre>

element cfDCResourceIdentifier__Type/cfDCScheme

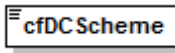
diagram	
namespace	urn:xmlns:org:eurocris:cerif-1.6-2
type	xs:string
properties	isRef 0 content simple
source	<pre><xs:element name="cfDCScheme" type="xs:string"/></pre>

element cfDCResourceIdentifier__Type/cfDCLangTag

diagram	
namespace	urn:xmlns:org:eurocris:cerif-1.6-2
type	xs:string
properties	isRef 0 content simple
source	<pre><xs:element name="cfDCLangTag" type="xs:string"/></pre>

element cfDCResourceIdentifier__Type/cfDCTrans

diagram	
namespace	urn:xmlns:org:eurocris:cerif-1.6-2
type	xs:string
properties	isRef 0 content simple
source	<pre><xs:element name="cfDCTrans" type="xs:string"/></pre>

element cfDCResourceIdentifier__Type/cfDCType

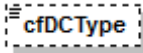
diagram	
namespace	urn:xmlns:org:eurocris:cerif-1.6-2
type	xs:string
properties	isRef 0 minOcc 0 maxOcc 1

	content simple
source	<code><xs:element name="cfDCType" type="xs:string" minOccurs="0"/></code>

element **cfDCResourceIdentifier__Type/cfDCValue**

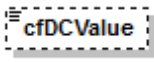
diagram	
namespace	urn:xmlns:org:eurocris:cerif-1.6-2
type	xs:string
properties	isRef 0 minOcc 0 maxOcc 1 content simple
source	<code><xs:element name="cfDCValue" type="xs:string" minOccurs="0"/></code>

complexType **cfDCResourceType__Type**

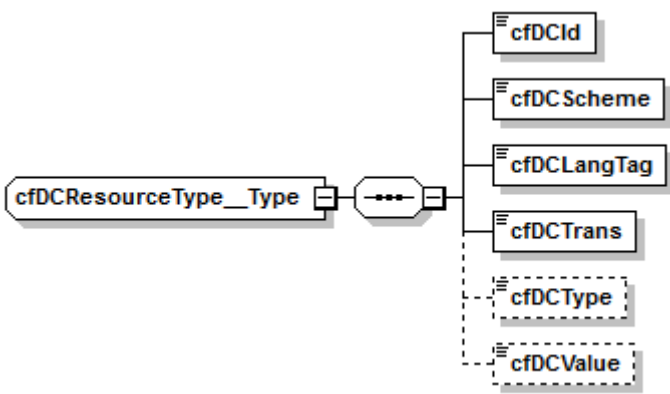
diagram	
namespace	urn:xmlns:org:eurocris:cerif-1.6-2
children	cfDCId cfDCScheme cfDCLangTag cfDCTrans cfDCType cfDCValue
used by	element CERIF/cfDCResourceType
source	<pre><xs:complexType name="cfDCResourceType__Type"> <xs:sequence> <xs:element name="cfDCId" type="xs:string"/> <xs:element name="cfDCScheme" type="xs:string"/> <xs:element name="cfDCLangTag" type="xs:string"/> <xs:element name="cfDCTrans" type="xs:string"/> <xs:element name="cfDCType" type="xs:string" minOccurs="0"/> <xs:element name="cfDCValue" type="xs:string" minOccurs="0"/> </xs:sequence> </xs:complexType></pre>

element **cfDCResourceType__Type/cfDCId**

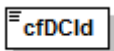
diagram	
namespace	urn:xmlns:org:eurocris:cerif-1.6-2
type	xs:string
properties	isRef 0 content simple
source	<code><xs:element name="cfDCId" type="xs:string"/></code>

element cfDCResourceType__Type/cfDCScheme

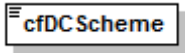
diagram	
namespace	urn:xmlns:org:eurocris:cerif-1.6-2
type	xs:string
properties	isRef 0 content simple
source	<code><xs:element name="cfDCScheme" type="xs:string"/></code>

element cfDCResourceType__Type/cfDCLangTag

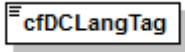
diagram	
namespace	urn:xmlns:org:eurocris:cerif-1.6-2
type	xs:string
properties	isRef 0 content simple
source	<code><xs:element name="cfDCLangTag" type="xs:string"/></code>

element cfDCResourceType__Type/cfDCTrans

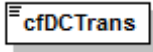
diagram	
namespace	urn:xmlns:org:eurocris:cerif-1.6-2
type	xs:string
properties	isRef 0 content simple
source	<code><xs:element name="cfDCTrans" type="xs:string"/></code>

element cfDCResourceType__Type/cfDCType

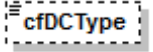
diagram	
namespace	urn:xmlns:org:eurocris:cerif-1.6-2
type	xs:string
properties	isRef 0 minOcc 0 maxOcc 1 content simple
source	<code><xs:element name="cfDCType" type="xs:string" minOccurs="0"/></code>

element cfDCResourceType__Type/cfDCValue

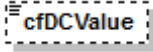
diagram	
namespace	urn:xmlns:org:eurocris:cerif-1.6-2
type	xs:string
properties	isRef 0 minOcc 0 maxOcc 1 content simple
source	<code><xs:element name="cfDCValue" type="xs:string" minOccurs="0"/></code>

complexType cfDCRightsHolder__Type

diagram	
namespace	urn:xmlns:org:eurocris:cerif-1.6-2
children	cfDCId cfDCScheme cfDCLangTag cfDCTrans cfDCType cfDCValue
used by	element CERIF/cfDCRightsHolder
source	<pre><xs:complexType name="cfDCRightsHolder__Type"> <xs:sequence> <xs:element name="cfDCId" type="xs:string"/> <xs:element name="cfDCScheme" type="xs:string"/> <xs:element name="cfDCLangTag" type="xs:string"/> <xs:element name="cfDCTrans" type="xs:string"/> <xs:element name="cfDCType" type="xs:string" minOccurs="0"/> <xs:element name="cfDCValue" type="xs:string" minOccurs="0"/> </xs:sequence> </xs:complexType></pre>

element cfDCRightsHolder__Type/cfDCId

diagram	
namespace	urn:xmlns:org:eurocris:cerif-1.6-2
type	xs:string
properties	isRef 0 content simple
source	<pre><xs:element name="cfDCId" type="xs:string"/></pre>

element cfDCRightsHolder__Type/cfDCScheme

diagram	
namespace	urn:xmlns:org:eurocris:cerif-1.6-2
type	xs:string
properties	isRef 0 content simple
source	<pre><xs:element name="cfDCScheme" type="xs:string"/></pre>

element cfDCRightsHolder__Type/cfDCLangTag

diagram	
namespace	urn:xmlns:org:eurocris:cerif-1.6-2
type	xs:string

properties	isRef 0 content simple
source	<xs:element name="cfDCLangTag" type="xs:string"/>

element cfDCRightsHolder__Type/cfDCTrans

diagram	
namespace	urn:xmlns:org:eurocris:cerif-1.6-2
type	xs:string
properties	isRef 0 content simple
source	<xs:element name="cfDCTrans" type="xs:string"/>

element cfDCRightsHolder__Type/cfDCType

diagram	
namespace	urn:xmlns:org:eurocris:cerif-1.6-2
type	xs:string
properties	isRef 0 minOcc 0 maxOcc 1 content simple
source	<xs:element name="cfDCType" type="xs:string" minOccurs="0"/>

element cfDCRightsHolder__Type/cfDCValue

diagram	
namespace	urn:xmlns:org:eurocris:cerif-1.6-2
type	xs:string
properties	isRef 0 minOcc 0 maxOcc 1 content simple
source	<xs:element name="cfDCValue" type="xs:string" minOccurs="0"/>

complexType cfDCRightsMM__Type

diagram	
namespace	urn:xmlns:org:eurocris:cerif-1.6-2
children	cfDCId cfDCScheme cfDCLangTag cfDCTrans cfDCValue cfDCType
used by	element CERIF/cfDCRightsMM

source	<pre><xs:complexType name="cfDCRightsMM__Type"> <xs:sequence> <xs:element name="cfDCId" type="xs:string"/> <xs:element name="cfDCScheme" type="xs:string"/> <xs:element name="cfDCLangTag" type="xs:string"/> <xs:element name="cfDCTrans" type="xs:string"/> <xs:element name="cfDCValue" type="xs:string" minOccurs="0"/> <xs:element name="cfDCType" type="xs:string" minOccurs="0"/> </xs:sequence> </xs:complexType></pre>
--------	---

element cfDCRightsMM__Type/cfDCId

diagram	
namespace	urn:xmlns:org:eurocris:cerif-1.6-2
type	xs:string
properties	isRef 0 content simple
source	<pre><xs:element name="cfDCId" type="xs:string"/></pre>

element cfDCRightsMM__Type/cfDCScheme

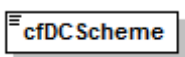
diagram	
namespace	urn:xmlns:org:eurocris:cerif-1.6-2
type	xs:string
properties	isRef 0 content simple
source	<pre><xs:element name="cfDCScheme" type="xs:string"/></pre>

element cfDCRightsMM__Type/cfDCLangTag

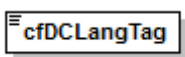
diagram	
namespace	urn:xmlns:org:eurocris:cerif-1.6-2
type	xs:string
properties	isRef 0 content simple
source	<pre><xs:element name="cfDCLangTag" type="xs:string"/></pre>

element cfDCRightsMM__Type/cfDCTrans

diagram	
namespace	urn:xmlns:org:eurocris:cerif-1.6-2
type	xs:string
properties	isRef 0 content simple
source	<pre><xs:element name="cfDCTrans" type="xs:string"/></pre>

element **cfDCRightsMM__Type/cfDCValue**

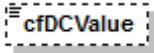
diagram	
namespace	urn:xmlns:org:eurocris:cerif-1.6-2
type	xs:string
properties	isRef 0 minOcc 0 maxOcc 1 content simple
source	<code><xs:element name="cfDCValue" type="xs:string" minOccurs="0"/></code>

element **cfDCRightsMM__Type/cfDCType**

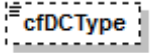
diagram	
namespace	urn:xmlns:org:eurocris:cerif-1.6-2
type	xs:string
properties	isRef 0 minOcc 0 maxOcc 1 content simple
source	<code><xs:element name="cfDCType" type="xs:string" minOccurs="0"/></code>

complexType **cfDCRightsMMAccessRights__Type**

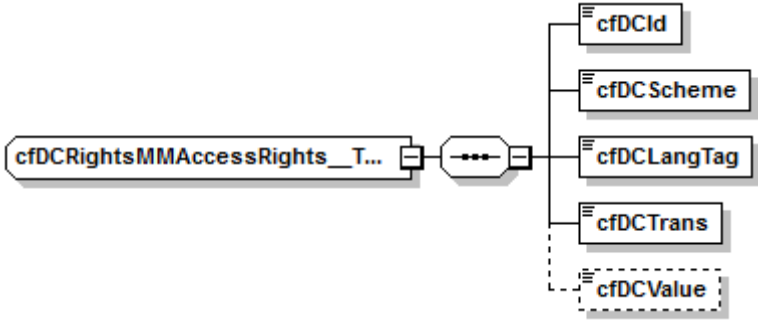
diagram	
namespace	urn:xmlns:org:eurocris:cerif-1.6-2
children	cfDCId cfDCScheme cfDCLangTag cfDCTrans cfDCValue
used by	element CERIF/cfDCRightsMMAccessRights
source	<pre><xs:complexType name="cfDCRightsMMAccessRights__Type"> <xs:sequence> <xs:element name="cfDCId" type="xs:string"/> <xs:element name="cfDCScheme" type="xs:string"/> <xs:element name="cfDCLangTag" type="xs:string"/> <xs:element name="cfDCTrans" type="xs:string"/> <xs:element name="cfDCValue" type="xs:string" minOccurs="0"/> </xs:sequence> </xs:complexType></pre>

element **cfDCRightsMMAccessRights__Type/cfDCId**

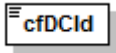
diagram	
namespace	urn:xmlns:org:eurocris:cerif-1.6-2
type	xs:string

properties	isRef 0 content simple
source	<code><xs:element name="cfDCId" type="xs:string"/></code>

element **cfDCRightsMMAccessRights__Type/cfDCScheme**

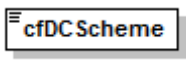
diagram	
namespace	urn:xmlns:org:eurocris:cerif-1.6-2
type	xs:string
properties	isRef 0 content simple
source	<code><xs:element name="cfDCScheme" type="xs:string"/></code>

element **cfDCRightsMMAccessRights__Type/cfDCLangTag**

diagram	
namespace	urn:xmlns:org:eurocris:cerif-1.6-2
type	xs:string
properties	isRef 0 content simple
source	<code><xs:element name="cfDCLangTag" type="xs:string"/></code>

element **cfDCRightsMMAccessRights__Type/cfDCTrans**

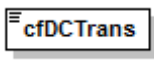
diagram	
namespace	urn:xmlns:org:eurocris:cerif-1.6-2
type	xs:string
properties	isRef 0 content simple
source	<code><xs:element name="cfDCTrans" type="xs:string"/></code>

element **cfDCRightsMMAccessRights__Type/cfDCValue**

diagram	
namespace	urn:xmlns:org:eurocris:cerif-1.6-2
type	xs:string
properties	isRef 0 minOcc 0 maxOcc 1 content simple
source	<code><xs:element name="cfDCValue" type="xs:string" minOccurs="0"/></code>

complexType **cfDCRightsMMLicense__Type**

diagram	
namespace	urn:xmlns:org:eurocris:cerif-1.6-2
children	cfDCId cfDCScheme cfDCLangTag cfDCTrans cfDCValue
used by	element CERIF/cfDCRightsMMLicense
source	<pre><xs:complexType name="cfDCRightsMMLicense__Type"> <xs:sequence> <xs:element name="cfDCId" type="xs:string"/> <xs:element name="cfDCScheme" type="xs:string"/> <xs:element name="cfDCLangTag" type="xs:string"/> <xs:element name="cfDCTrans" type="xs:string"/> <xs:element name="cfDCValue" type="xs:string" minOccurs="0"/> </xs:sequence> </xs:complexType></pre>

element **cfDCRightsMMLicense__Type/cfDCId**

diagram	
namespace	urn:xmlns:org:eurocris:cerif-1.6-2
type	xs:string
properties	isRef 0 content simple
source	<pre><xs:element name="cfDCId" type="xs:string"/></pre>

element **cfDCRightsMMLicense__Type/cfDCScheme**

diagram	
namespace	urn:xmlns:org:eurocris:cerif-1.6-2
type	xs:string
properties	isRef 0 content simple
source	<pre><xs:element name="cfDCScheme" type="xs:string"/></pre>

element **cfDCRightsMMLicense__Type/cfDCLangTag**

diagram	
namespace	urn:xmlns:org:eurocris:cerif-1.6-2
type	xs:string
properties	isRef 0 content simple
source	<pre><xs:element name="cfDCLangTag" type="xs:string"/></pre>

element **cfDCRightsMMLicense__Type/cfDCTrans**

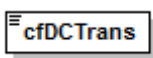
diagram	
namespace	urn:xmlns:org:eurocris:cerif-1.6-2
type	xs:string
properties	isRef 0 content simple
source	<code><xs:element name="cfDCTrans" type="xs:string"/></code>

element **cfDCRightsMMLicense__Type/cfDCValue**

diagram	
namespace	urn:xmlns:org:eurocris:cerif-1.6-2
type	xs:string
properties	isRef 0 minOcc 0 maxOcc 1 content simple
source	<code><xs:element name="cfDCValue" type="xs:string" minOccurs="0"/></code>

complexType **cfDCSource__Type**

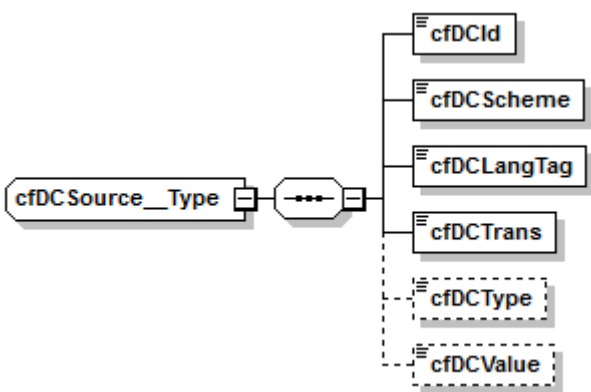
diagram	
namespace	urn:xmlns:org:eurocris:cerif-1.6-2
children	cfDCId cfDCScheme cfDCLangTag cfDCTrans cfDCType cfDCValue
used by	element CERIF/cfDCSource
source	<pre><xs:complexType name="cfDCSource__Type"> <xs:sequence> <xs:element name="cfDCId" type="xs:string"/> <xs:element name="cfDCScheme" type="xs:string"/> <xs:element name="cfDCLangTag" type="xs:string"/> <xs:element name="cfDCTrans" type="xs:string"/> <xs:element name="cfDCType" type="xs:string" minOccurs="0"/> <xs:element name="cfDCValue" type="xs:string" minOccurs="0"/> </xs:sequence> </xs:complexType></pre>

element **cfDCSource__Type/cfDCId**

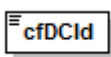
diagram	
namespace	urn:xmlns:org:eurocris:cerif-1.6-2

type	xs:string
properties	isRef 0 content simple
source	<code><xs:element name="cfDCId" type="xs:string"/></code>

element cfDCSource__Type/cfDCScheme

diagram	
namespace	urn:xmlns:org:eurocris:cerif-1.6-2
type	xs:string
properties	isRef 0 content simple
source	<code><xs:element name="cfDCScheme" type="xs:string"/></code>

element cfDCSource__Type/cfDCLangTag

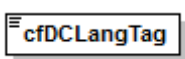
diagram	
namespace	urn:xmlns:org:eurocris:cerif-1.6-2
type	xs:string
properties	isRef 0 content simple
source	<code><xs:element name="cfDCLangTag" type="xs:string"/></code>

element cfDCSource__Type/cfDCTrans

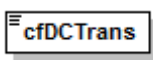
diagram	
namespace	urn:xmlns:org:eurocris:cerif-1.6-2
type	xs:string
properties	isRef 0 content simple
source	<code><xs:element name="cfDCTrans" type="xs:string"/></code>

element cfDCSource__Type/cfDCType

diagram	
namespace	urn:xmlns:org:eurocris:cerif-1.6-2
type	xs:string
properties	isRef 0 minOcc 0 maxOcc 1 content simple
source	<code><xs:element name="cfDCType" type="xs:string" minOccurs="0"/></code>

element cfDCSource__Type/cfDCValue

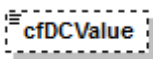
diagram	
namespace	urn:xmlns:org:eurocris:cerif-1.6-2
type	xs:string
properties	isRef 0 minOcc 0

	maxOcc 1 content simple
source	<code><xs:element name="cfDCValue" type="xs:string" minOccurs="0"/></code>

complexType cfDCSubject__Type

diagram	
namespace	urn:xmlns:org:eurocris:cerif-1.6-2
children	cfDCId cfDCScheme cfDCLangTag cfDCTrans cfDCType cfDCValue
used by	element CERIF/cfDCSubject
source	<pre> <xs:complexType name="cfDCSubject__Type"> <xs:sequence> <xs:element name="cfDCId" type="xs:string"/> <xs:element name="cfDCScheme" type="xs:string"/> <xs:element name="cfDCLangTag" type="xs:string"/> <xs:element name="cfDCTrans" type="xs:string"/> <xs:element name="cfDCType" type="xs:string" minOccurs="0"/> <xs:element name="cfDCValue" type="xs:string" minOccurs="0"/> </xs:sequence> </xs:complexType> </pre>

element cfDCSubject__Type/cfDCId

diagram	
namespace	urn:xmlns:org:eurocris:cerif-1.6-2
type	xs:string
properties	isRef 0 content simple
source	<code><xs:element name="cfDCId" type="xs:string"/></code>

element cfDCSubject__Type/cfDCScheme

diagram	
namespace	urn:xmlns:org:eurocris:cerif-1.6-2
type	xs:string
properties	isRef 0 content simple
source	<code><xs:element name="cfDCScheme" type="xs:string"/></code>

element **cfDCSubject_Type/cfDCLangTag**

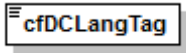
diagram	
namespace	urn:xmlns:org:eurocris:cerif-1.6-2
type	xs:string
properties	isRef 0 content simple
source	<code><xs:element name="cfDCLangTag" type="xs:string"/></code>

element **cfDCSubject_Type/cfDCTrans**

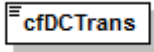
diagram	
namespace	urn:xmlns:org:eurocris:cerif-1.6-2
type	xs:string
properties	isRef 0 content simple
source	<code><xs:element name="cfDCTrans" type="xs:string"/></code>

element **cfDCSubject_Type/cfDCType**

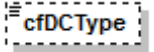
diagram	
namespace	urn:xmlns:org:eurocris:cerif-1.6-2
type	xs:string
properties	isRef 0 minOcc 0 maxOcc 1 content simple
source	<code><xs:element name="cfDCType" type="xs:string" minOccurs="0"/></code>

element **cfDCSubject_Type/cfDCValue**

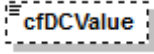
diagram	
namespace	urn:xmlns:org:eurocris:cerif-1.6-2
type	xs:string
properties	isRef 0 minOcc 0 maxOcc 1 content simple
source	<code><xs:element name="cfDCValue" type="xs:string" minOccurs="0"/></code>

complexType **cfDCTitle__Type**

diagram	
namespace	urn:xmlns:org:eurocris:cerif-1.6-2
children	cfDCId cfDCScheme cfDCLangTag cfDCTrans cfDCType cfDCValue
used by	element CERIF/cfDCTitle
source	<pre><xs:complexType name="cfDCTitle__Type"> <xs:sequence> <xs:element name="cfDCId" type="xs:string"/> <xs:element name="cfDCScheme" type="xs:string"/> <xs:element name="cfDCLangTag" type="xs:string"/> <xs:element name="cfDCTrans" type="xs:string"/> <xs:element name="cfDCType" type="xs:string" minOccurs="0"/> <xs:element name="cfDCValue" type="xs:string" minOccurs="0"/> </xs:sequence> </xs:complexType></pre>

element **cfDCTitle__Type/cfDCId**

diagram	
namespace	urn:xmlns:org:eurocris:cerif-1.6-2
type	xs:string
properties	isRef 0 content simple
source	<pre><xs:element name="cfDCId" type="xs:string"/></pre>

element **cfDCTitle__Type/cfDCScheme**

diagram	
namespace	urn:xmlns:org:eurocris:cerif-1.6-2
type	xs:string
properties	isRef 0 content simple
source	<pre><xs:element name="cfDCScheme" type="xs:string"/></pre>

element **cfDCTitle__Type/cfDCLangTag**

diagram	
namespace	urn:xmlns:org:eurocris:cerif-1.6-2
type	xs:string

properties	isRef 0 content simple
source	<xs:element name="cfDCLangTag" type="xs:string"/>

element cfDCTitle__Type/cfDCTrans

diagram	
namespace	urn:xmlns:org:eurocris:cerif-1.6-2
type	xs:string
properties	isRef 0 content simple
source	<xs:element name="cfDCTrans" type="xs:string"/>

element cfDCTitle__Type/cfDCType

diagram	
namespace	urn:xmlns:org:eurocris:cerif-1.6-2
type	xs:string
properties	isRef 0 minOcc 0 maxOcc 1 content simple
source	<xs:element name="cfDCType" type="xs:string" minOccurs="0"/>

element cfDCTitle__Type/cfDCValue

diagram	
namespace	urn:xmlns:org:eurocris:cerif-1.6-2
type	xs:string
properties	isRef 0 minOcc 0 maxOcc 1 content simple
source	<xs:element name="cfDCValue" type="xs:string" minOccurs="0"/>

complexType cfEAddr__Type

diagram	
namespace	urn:xmlns:org:eurocris:cerif-1.6-2
children	cfEAddrId cfPAddrId cfURI cfOrgUnit_EAddr cfPers_EAddr cfEAddr_Class cfFedId

used by	element CERIF/cfEAddr
source	<pre> <xs:complexType name="cfEAddr__Type"> <xs:sequence> <xs:element name="cfEAddrId" type="cfd__Type"/> <xs:element name="cfPAddrId" type="cfd__Type" minOccurs="0"/> <xs:element name="cfURI" type="xs:string" minOccurs="0"/> <xs:choice minOccurs="0" maxOccurs="unbounded"> <!-- embedded linking entities --> <xs:element name="cfOrgUnit_EAddr"> <xs:complexType> <xs:sequence> <xs:element name="cfOrgUnitId" type="cfd__Type"/> <xs:group ref="cfCoreClassWithFraction__Group"/> </xs:sequence> </xs:complexType> </xs:element> <xs:element name="cfPers_EAddr"> <xs:complexType> <xs:sequence> <xs:element name="cfPersId" type="cfd__Type"/> <xs:group ref="cfCoreClassWithFraction__Group"/> </xs:sequence> </xs:complexType> </xs:element> <xs:element name="cfEAddr_Class" type="cfCoreClassWithFraction__Type"/> <!-- embedded federated identifiers --> <xs:element name="cfFedId" type="cfFedId__EmbType"/> </xs:choice> </xs:sequence> </xs:complexType> </pre>

element cfEAddr__Type/cfEAddrId

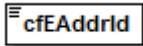
diagram	
namespace	urn.xmlns.org:eurocris:cerif-1.6-2
type	cfd__Type
properties	isRef 0 content simple
facets	Kind Value annotation maxLength 128
source	<pre><xs:element name="cfEAddrId" type="cfd__Type"/></pre>

element cfEAddr__Type/cfPAddrId

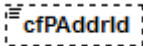
diagram	
namespace	urn.xmlns.org:eurocris:cerif-1.6-2
type	cfd__Type
properties	isRef 0 minOcc 0 maxOcc 1 content simple
facets	Kind Value annotation maxLength 128
source	<pre><xs:element name="cfPAddrId" type="cfd__Type" minOccurs="0"/></pre>

element cfEAddr_Type/cfURI

diagram	
namespace	urn:xmlns:org:eurocris:cerif-1.6-2
type	xs:string
properties	isRef 0 minOcc 0 maxOcc 1 content simple
source	<xs:element name="cfURI" type="xs:string" minOccurs="0"/>

element cfEAddr_Type/cfOrgUnit_EAddr

diagram	
namespace	urn:xmlns:org:eurocris:cerif-1.6-2
properties	isRef 0 content complex
children	cfOrgUnitId cfClassId cfClassSchemeld cfStartDate cfEndDate cfFraction
source	<xs:element name="cfOrgUnit_EAddr"> <xs:complexType> <xs:sequence> <xs:element name="cfOrgUnitId" type="cfId__Type"/> <xs:group ref="cfCoreClassWithFraction__Group"/> </xs:sequence> </xs:complexType> </xs:element>

element cfEAddr_Type/cfOrgUnit_EAddr/cfOrgUnitId

diagram	
namespace	urn:xmlns:org:eurocris:cerif-1.6-2
type	cfId_Type
properties	isRef 0 content simple
facets	Kind Value annotation maxLength 128
source	<xs:element name="cfOrgUnitId" type="cfId__Type"/>

element cfEAddr_Type/cfPers_EAddr

diagram	
namespace	urn:xmlns:org:eurocris:cerif-1.6-2
properties	isRef 0 content complex
children	cfPersId cfClassId cfClassSchemeld cfStartDate cfEndDate cfFraction
source	<pre><xs:element name="cfPers_EAddr"> <xs:complexType> <xs:sequence> <xs:element name="cfPersId" type="cfId__Type"/> <xs:group ref="cfCoreClassWithFraction__Group"/> </xs:sequence> </xs:complexType> </xs:element></pre>

element cfEAddr_Type/cfPers_EAddr/cfPersId

diagram	
namespace	urn:xmlns:org:eurocris:cerif-1.6-2
type	cfId_Type
properties	isRef 0 content simple
facets	Kind Value annotation maxLength 128
source	<pre><xs:element name="cfPersId" type="cfId__Type"/></pre>

element cfEAddr_Type/cfEAddr_Class

diagram	
namespace	urn:xmlns:org:eurocris:cerif-1.6-2
type	cfCoreClassWithFraction_Type
properties	isRef 0 content complex
children	cfClassId cfClassSchemeld cfStartDate cfEndDate cfFraction
source	<pre><xs:element name="cfEAddr_Class" type="cfCoreClassWithFraction__Type"/></pre>

element **cfEAddr__Type/cfFedId**

diagram	
namespace	urn:xmlns:org:eurocris:cerif-1.6-2
type	cfFedId__EmbType
properties	isRef 0 content complex
children	cfFedIdId cfFedId cfClassId cfClassSchemeld cfStartDate cfEndDate cfFedId__Class
source	<code><xs:element name="cfFedId" type="cfFedId__EmbType"/></code>

complexType **cfEAddr__Class__Type**

diagram	
namespace	urn:xmlns:org:eurocris:cerif-1.6-2
children	cfEAddrId cfClassId cfClassSchemeld cfStartDate cfEndDate cfFraction
used by	element CERIF/cfEAddr__Class
source	<pre> <xs:complexType name="cfEAddr__Class__Type"> <xs:sequence> <xs:element name="cfEAddrId" type="cfId__Type"/> <xs:group ref="cfCoreClassWithFraction__Group"/> </xs:sequence> </xs:complexType> </pre>

element **cfEAddr__Class__Type/cfEAddrId**

diagram	
namespace	urn:xmlns:org:eurocris:cerif-1.6-2
type	cfId__Type
properties	isRef 0 content simple

facets	Kind maxLength	Value 128	annotation
source	<code><xs:element name="cfEAddrId" type="cfId__Type"/></code>		

complexType cfEvent__Type

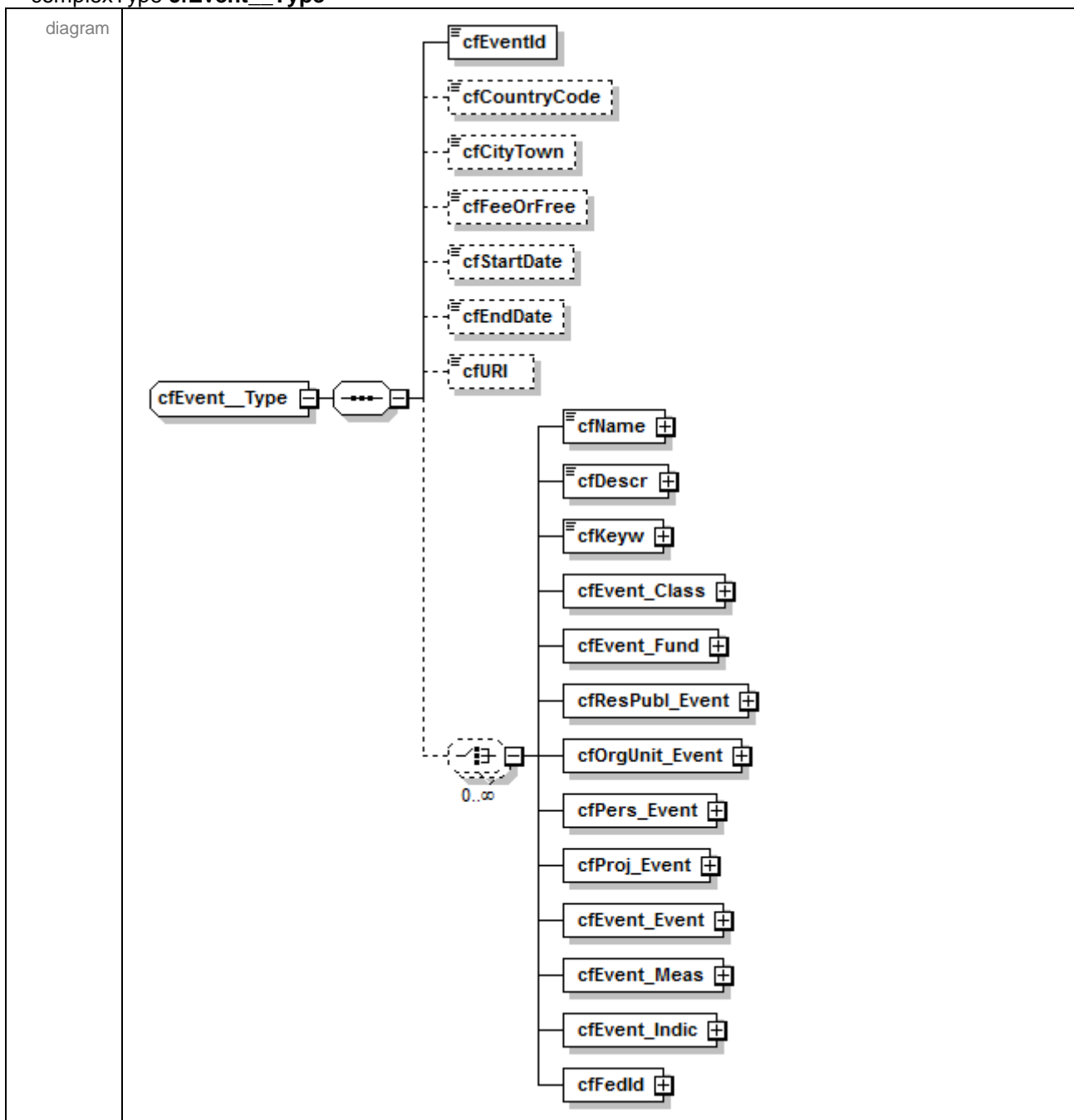

namespace	urn:xmlns:org:eurocris:cerif-1.6-2
children	cfEventId cfCountryCode cfCityTown cfFeeOrFree cfStartDate cfEndDate cfURI cfName cfDescr cfKeyw cfEvent_Class cfEvent_Fund cfResPubl_Event cfOrgUnit_Event cfPers_Event cfProj_Event cfEvent_Event cfEvent_Meas cfEvent_Indic cfFedId
used by	element CERIF/cfEvent
source	<code><xs:complexType name="cfEvent__Type"> <xs:sequence> <xs:element name="cfEventId" type="cfId__Type"/> <xs:element name="cfCountryCode" type="xs:string" minOccurs="0"/> <xs:element name="cfCityTown" type="xs:string" minOccurs="0"/> <xs:element name="cfFeeOrFree" type="xs:string" minOccurs="0"/></code>

```

<xs:element name="cfStartDate" type="xs:date" minOccurs="0"/>
<xs:element name="cfEndDate" type="xs:date" minOccurs="0"/>
<xs:element name="cfURI" type="xs:string" minOccurs="0"/>
<xs:choice minOccurs="0" maxOccurs="unbounded">
  <!-- embedded multiple-language attributes -->
  <xs:element name="cfName" type="cfMLangString__Type"/>
  <xs:element name="cfDescr" type="cfMLangString__Type"/>
  <xs:element name="cfKeyw" type="cfMLangString__Type"/>
  <!-- embedded linking entities -->
  <xs:element name="cfEvent_Class" type="cfCoreClassWithFraction__Type"/>
  <xs:element name="cfEvent_Fund">
    <xs:complexType>
      <xs:sequence>
        <xs:element name="cfFundId" type="cfId__Type"/>
        <xs:group ref="cfCoreClassWithFraction__Group"/>
        <xs:element name="cfAmount" type="cfAmount__Type" minOccurs="0"/>
      </xs:sequence>
    </xs:complexType>
  </xs:element>
  <xs:element name="cfResPubl_Event">
    <xs:complexType>
      <xs:sequence>
        <xs:element name="cfResPublId" type="cfId__Type"/>
        <xs:group ref="cfCoreClassWithFraction__Group"/>
      </xs:sequence>
    </xs:complexType>
  </xs:element>
  <xs:element name="cfOrgUnit_Event">
    <xs:complexType>
      <xs:sequence>
        <xs:element name="cfOrgUnitId" type="cfId__Type"/>
        <xs:group ref="cfCoreClassWithFraction__Group"/>
      </xs:sequence>
    </xs:complexType>
  </xs:element>
  <xs:element name="cfPers_Event">
    <xs:complexType>
      <xs:sequence>
        <xs:element name="cfPersId" type="cfId__Type"/>
        <xs:group ref="cfCoreClassWithFraction__Group"/>
      </xs:sequence>
    </xs:complexType>
  </xs:element>
  <xs:element name="cfProj_Event">
    <xs:complexType>
      <xs:sequence>
        <xs:element name="cfProjId" type="cfId__Type"/>
        <xs:group ref="cfCoreClassWithFraction__Group"/>
      </xs:sequence>
    </xs:complexType>
  </xs:element>
  <xs:element name="cfEvent_Event">
    <xs:complexType>
      <xs:sequence>
        <xs:choice>
          <xs:element name="cfEventId2" type="cfId__Type"/>
          <xs:element name="cfEventId1" type="cfId__Type"/>
        </xs:choice>
        <xs:group ref="cfCoreClassWithFraction__Group"/>
      </xs:sequence>
    </xs:complexType>
  </xs:element>

```

	<pre> <xs:element name="cfEvent_Meas"> <xs:complexType> <xs:sequence> <xs:element name="cfMeasId" type="cfld__Type"/> <xs:group ref="cfCoreClassWithFraction__Group"/> </xs:sequence> </xs:complexType> </xs:element> <xs:element name="cfEvent_Indic"> <xs:complexType> <xs:sequence> <xs:element name="cfIndicId" type="cfld__Type"/> <xs:group ref="cfCoreClassWithFraction__Group"/> </xs:sequence> </xs:complexType> </xs:element> <!-- embedded federated identifiers --> <xs:element name="cfFedId" type="cfFedId__EmbType"/> </xs:choice> </xs:sequence> </xs:complexType> </pre>
--	---

element **cfEvent__Type/cfEventId**

diagram	
namespace	urn:xmlns:org:eurocris:cerif-1.6-2
type	cfld__Type
properties	isRef 0 content simple
facets	Kind Value annotation maxLength 128
source	<pre><xs:element name="cfEventId" type="cfld__Type"/></pre>

element **cfEvent__Type/cfCountryCode**

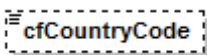
diagram	
namespace	urn:xmlns:org:eurocris:cerif-1.6-2
type	xs:string
properties	isRef 0 minOcc 0 maxOcc 1 content simple
source	<pre><xs:element name="cfCountryCode" type="xs:string" minOccurs="0"/></pre>

element **cfEvent__Type/cfCityTown**

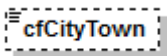
diagram	
namespace	urn:xmlns:org:eurocris:cerif-1.6-2
type	xs:string
properties	isRef 0 minOcc 0 maxOcc 1 content simple
source	<pre><xs:element name="cfCityTown" type="xs:string" minOccurs="0"/></pre>

element **cfEvent_Type/cfFeeOrFree**

diagram	
namespace	urn:xmlns:org:eurocris:cerif-1.6-2
type	xs:string
properties	isRef 0 minOcc 0 maxOcc 1 content simple
source	<code><xs:element name="cfFeeOrFree" type="xs:string" minOccurs="0"/></code>

element **cfEvent_Type/cfStartDate**

diagram	
namespace	urn:xmlns:org:eurocris:cerif-1.6-2
type	xs:date
properties	isRef 0 minOcc 0 maxOcc 1 content simple
source	<code><xs:element name="cfStartDate" type="xs:date" minOccurs="0"/></code>

element **cfEvent_Type/cfEndDate**

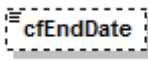
diagram	
namespace	urn:xmlns:org:eurocris:cerif-1.6-2
type	xs:date
properties	isRef 0 minOcc 0 maxOcc 1 content simple
source	<code><xs:element name="cfEndDate" type="xs:date" minOccurs="0"/></code>

element **cfEvent_Type/cfURI**

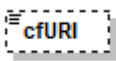
diagram	
namespace	urn:xmlns:org:eurocris:cerif-1.6-2
type	xs:string
properties	isRef 0 minOcc 0 maxOcc 1 content simple
source	<code><xs:element name="cfURI" type="xs:string" minOccurs="0"/></code>

element cfEvent__Type/cfName

diagram						
namespace	urn:xmlns:org:eurocris:cerif-1.6-2					
type	cfMLangString__Type					
properties	isRef	0	content	complex		
attributes	Name	Type	Use	Default	Fixed	annotation
	cfLangCode	xs:string	required			
	cfTrans	cfTrans__Type	required			
source	<code><xs:element name="cfName" type="cfMLangString__Type"/></code>					

element cfEvent__Type/cfDescr

diagram						
namespace	urn:xmlns:org:eurocris:cerif-1.6-2					
type	cfMLangString__Type					
properties	isRef	0	content	complex		
attributes	Name	Type	Use	Default	Fixed	annotation
	cfLangCode	xs:string	required			
	cfTrans	cfTrans__Type	required			
source	<code><xs:element name="cfDescr" type="cfMLangString__Type"/></code>					

element cfEvent__Type/cfKeyw

diagram						
namespace	urn:xmlns:org:eurocris:cerif-1.6-2					
type	cfMLangString__Type					
properties	isRef	0	content	complex		

attributes	Name	Type	Use	Default	Fixed	annotation
	cfLangCode	xs:string	required			
	cfTrans	cfTrans_Type	required			
source	<code><xs:element name="cfKeyw" type="cfMLangString__Type"/></code>					

element cfEvent_Type/cfEvent_Class

diagram	
namespace	urn.xmlns:org:eurocris:cerif-1.6-2
type	cfCoreClassWithFraction_Type
properties	isRef 0 content complex
children	cfClassId cfClassSchemeld cfStartDate cfEndDate cfFraction
source	<code><xs:element name="cfEvent_Class" type="cfCoreClassWithFraction__Type"/></code>

element cfEvent_Type/cfEvent_Fund

diagram	
namespace	urn.xmlns:org:eurocris:cerif-1.6-2
properties	isRef 0 content complex
children	cfFundId cfClassId cfClassSchemeld cfStartDate cfEndDate cfFraction cfAmount
source	<pre> <xs:element name="cfEvent_Fund"> <xs:complexType> <xs:sequence> <xs:element name="cfFundId" type="cfId__Type"/> <xs:group ref="cfCoreClassWithFraction__Group"/> <xs:element name="cfAmount" type="cfAmount__Type" minOccurs="0"/> </xs:sequence> </xs:complexType> </xs:element> </pre>

element cfEvent_Type/cfEvent_Fund/cfFundId

diagram	
---------	--

namespace	urn:xmls:org:eurocris:cerif-1.6-2
type	cflD_Type
properties	isRef 0 content simple
facets	Kind Value annotation maxLength 128
source	<code><xs:element name="cfFundId" type="cflD_Type"/></code>

element cfEvent_Type/cfEvent_Fund/cfAmount

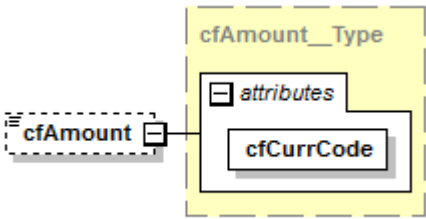
diagram													
namespace	urn:xmls:org:eurocris:cerif-1.6-2												
type	cfAmount_Type												
properties	isRef 0 minOcc 0 maxOcc 1 content complex												
attributes	<table border="1"> <thead> <tr> <th>Name</th> <th>Type</th> <th>Use</th> <th>Default</th> <th>Fixed</th> <th>annotation</th> </tr> </thead> <tbody> <tr> <td>cfCurrCode</td> <td>xs:string</td> <td>required</td> <td></td> <td></td> <td></td> </tr> </tbody> </table>	Name	Type	Use	Default	Fixed	annotation	cfCurrCode	xs:string	required			
Name	Type	Use	Default	Fixed	annotation								
cfCurrCode	xs:string	required											
source	<code><xs:element name="cfAmount" type="cfAmount_Type" minOccurs="0"/></code>												

element cfEvent_Type/cfResPubl_Event

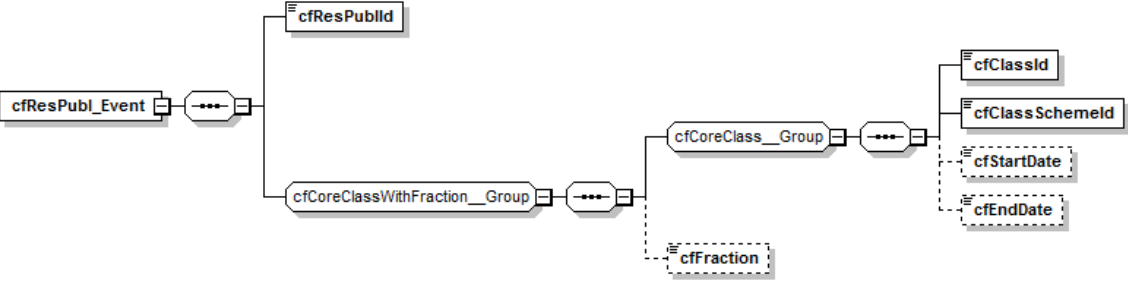
diagram	
namespace	urn:xmls:org:eurocris:cerif-1.6-2
properties	isRef 0 content complex
children	cfResPublId cfClassId cfClassSchemeld cfStartDate cfEndDate cfFraction
source	<pre> <xs:element name="cfResPubl_Event"> <xs:complexType> <xs:sequence> <xs:element name="cfResPublId" type="cflD_Type"/> <xs:group ref="cfCoreClassWithFraction_Group"/> </xs:sequence> </xs:complexType> </xs:element> </pre>

element cfEvent_Type/cfResPubl_Event/cfResPublId

diagram	
---------	---

namespace	urn:xmlns:org:eurocris:cerif-1.6-2
type	cfld_Type
properties	isRef 0 content simple
facets	Kind Value annotation maxLength 128
source	<code><xs:element name="cfResPublId" type="cfld_Type"/></code>

element **cfEvent_Type/cfOrgUnit_Event**

diagram	
namespace	urn:xmlns:org:eurocris:cerif-1.6-2
properties	isRef 0 content complex
children	cfOrgUnitId cfClassId cfClassSchemeld cfStartDate cfEndDate cfFraction
source	<pre> <xs:element name="cfOrgUnit_Event"> <xs:complexType> <xs:sequence> <xs:element name="cfOrgUnitId" type="cfld_Type"/> <xs:group ref="cfCoreClassWithFraction_Group"/> </xs:sequence> </xs:complexType> </xs:element> </pre>

element **cfEvent_Type/cfOrgUnit_Event/cfOrgUnitId**

diagram	
namespace	urn:xmlns:org:eurocris:cerif-1.6-2
type	cfld_Type
properties	isRef 0 content simple
facets	Kind Value annotation maxLength 128
source	<code><xs:element name="cfOrgUnitId" type="cfld_Type"/></code>

element **cfEvent_Type/cfPers_Event**

diagram	
---------	--

namespace	urn:xmlns:org:eurocris:cerif-1.6-2
properties	isRef 0 content complex
children	cfPersId cfClassId cfClassSchemeld cfStartDate cfEndDate cfFraction
source	<pre><xs:element name="cfPers_Event"> <xs:complexType> <xs:sequence> <xs:element name="cfPersId" type="cfId__Type"/> <xs:group ref="cfCoreClassWithFraction__Group"/> </xs:sequence> </xs:complexType> </xs:element></pre>

element cfEvent__Type/cfPers_Event/cfPersId

diagram	
namespace	urn:xmlns:org:eurocris:cerif-1.6-2
type	cfId__Type
properties	isRef 0 content simple
facets	Kind Value annotation maxLength 128
source	<pre><xs:element name="cfPersId" type="cfId__Type"/></pre>

element cfEvent__Type/cfProj_Event

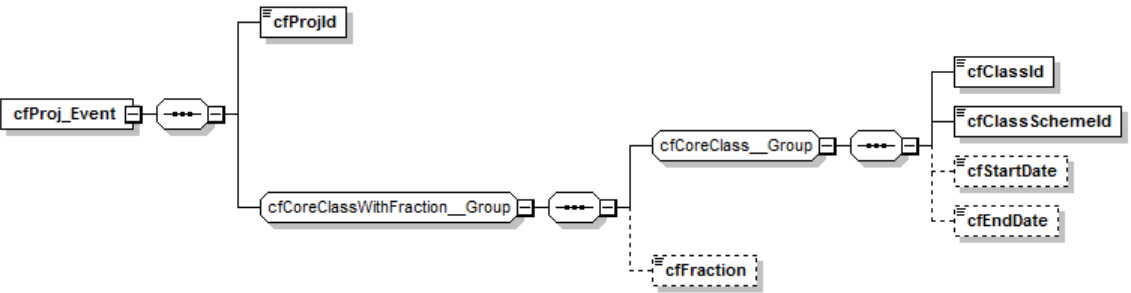
diagram	
namespace	urn:xmlns:org:eurocris:cerif-1.6-2
properties	isRef 0 content complex
children	cfProjId cfClassId cfClassSchemeld cfStartDate cfEndDate cfFraction
source	<pre><xs:element name="cfProj_Event"> <xs:complexType> <xs:sequence> <xs:element name="cfProjId" type="cfId__Type"/> <xs:group ref="cfCoreClassWithFraction__Group"/> </xs:sequence> </xs:complexType> </xs:element></pre>

element cfEvent__Type/cfProj_Event/cfProjId

diagram	
namespace	urn:xmlns:org:eurocris:cerif-1.6-2
type	cfId__Type
properties	isRef 0

	content simple
facets	Kind Value annotation maxLength 128
source	<xs:element name="cfProjId" type="cflD__Type"/>

element cfEvent__Type/cfEvent_Event

diagram	
namespace	urn:xmlns:org:eurocris:cerif-1.6-2
properties	isRef 0 content complex
children	cfEventId2 cfEventId1 cfClassId cfClassSchemeld cfStartDate cfEndDate cfFraction
source	<pre> <xs:element name="cfEvent_Event"> <xs:complexType> <xs:sequence> <xs:choice> <xs:element name="cfEventId2" type="cflD__Type"/> <xs:element name="cfEventId1" type="cflD__Type"/> </xs:choice> <xs:group ref="cfCoreClassWithFraction__Group"/> </xs:sequence> </xs:complexType> </xs:element> </pre>

element cfEvent__Type/cfEvent_Event/cfEventId2

diagram	
namespace	urn:xmlns:org:eurocris:cerif-1.6-2
type	cflD__Type
properties	isRef 0 content simple
facets	Kind Value annotation maxLength 128
source	<xs:element name="cfEventId2" type="cflD__Type"/>

element cfEvent__Type/cfEvent_Event/cfEventId1

diagram	
namespace	urn:xmlns:org:eurocris:cerif-1.6-2
type	cflD__Type
properties	isRef 0 content simple
facets	Kind Value annotation maxLength 128

source	<xs:element name="cfEventId1" type="cflD__Type"/>
--------	---

element cfEvent_Type/cfEvent_Meas

diagram	
namespace	urn:xmlns:org:eurocris:cerif-1.6-2
properties	isRef 0 content complex
children	cfMeasId cfClassId cfClassSchemeld cfStartDate cfEndDate cfFraction
source	<pre><xs:element name="cfEvent_Meas"> <xs:complexType> <xs:sequence> <xs:element name="cfMeasId" type="cflD__Type"/> <xs:group ref="cfCoreClassWithFraction__Group"/> </xs:sequence> </xs:complexType> </xs:element></pre>

element cfEvent_Type/cfEvent_Meas/cfMeasId

diagram	
namespace	urn:xmlns:org:eurocris:cerif-1.6-2
type	cflD__Type
properties	isRef 0 content simple
facets	Kind Value annotation maxLength 128
source	<xs:element name="cfMeasId" type="cflD__Type"/>

element cfEvent_Type/cfEvent_Indic

diagram	
namespace	urn:xmlns:org:eurocris:cerif-1.6-2
properties	isRef 0 content complex
children	cfIndicId cfClassId cfClassSchemeld cfStartDate cfEndDate cfFraction
source	<pre><xs:element name="cfEvent_Indic"> <xs:complexType></pre>

	<pre> <xs:sequence> <xs:element name="cfIndicld" type="cfld__Type"/> <xs:group ref="cfCoreClassWithFraction__Group"/> </xs:sequence> </xs:complexType> </xs:element> </pre>
--	---

element cfEvent__Type/cfEvent_Indic/cfIndicld

diagram	
namespace	urn:xmlns:org:eurocris:cerif-1.6-2
type	cfld__Type
properties	isRef 0 content simple
facets	Kind Value annotation maxLength 128
source	<code><xs:element name="cfIndicld" type="cfld__Type"/></code>

element cfEvent__Type/cfFedld

diagram	
namespace	urn:xmlns:org:eurocris:cerif-1.6-2
type	cfFedld__EmbType
properties	isRef 0 content complex
children	cfFedldld cfFedld cfClassld cfClassSchemeld cfStartDate cfEndDate cfFedld_Class
source	<code><xs:element name="cfFedld" type="cfFedld__EmbType"/></code>

complexType cfEvent_Class_Type

diagram	
namespace	urn:xmlns:org:eurocris:cerif-1.6-2
children	cfEventId cfClassId cfClassSchemeld cfStartDate cfEndDate cfFraction
used by	element CERIF/cfEvent_Class
source	<pre><xs:complexType name="cfEvent_Class_Type"> <xs:sequence> <xs:element name="cfEventId" type="cfId__Type"/> <xs:group ref="cfCoreClassWithFraction_Group"/> </xs:sequence> </xs:complexType></pre>

element cfEvent_Class_Type/cfEventId

diagram	
namespace	urn:xmlns:org:eurocris:cerif-1.6-2
type	cfId_Type
properties	isRef 0 content simple
facets	Kind Value annotation maxLength 128
source	<pre><xs:element name="cfEventId" type="cfId__Type"/></pre>

complexType cfEvent_Event_Type

diagram	
namespace	urn:xmlns:org:eurocris:cerif-1.6-2
children	cfEventId1 cfEventId2 cfClassId cfClassSchemeld cfStartDate cfEndDate cfFraction
used by	element CERIF/cfEvent_Event
source	<pre><xs:complexType name="cfEvent_Event_Type"> <xs:sequence> <xs:element name="cfEventId1" type="cfId__Type"/> <xs:element name="cfEventId2" type="cfId__Type"/> <xs:group ref="cfCoreClassWithFraction_Group"/> </xs:sequence> </xs:complexType></pre>

element **cfEvent_Event_Type/cfEventId1**

diagram	
namespace	urn:xmlns:org:eurocris:cerif-1.6-2
type	cfId_Type
properties	isRef 0 content simple
facets	Kind Value annotation maxLength 128
source	<code><xs:element name="cfEventId1" type="cfId_Type"/></code>

element **cfEvent_Event_Type/cfEventId2**

diagram	
namespace	urn:xmlns:org:eurocris:cerif-1.6-2
type	cfId_Type
properties	isRef 0 content simple
facets	Kind Value annotation maxLength 128
source	<code><xs:element name="cfEventId2" type="cfId_Type"/></code>

complexType **cfEvent_Fund_Type**

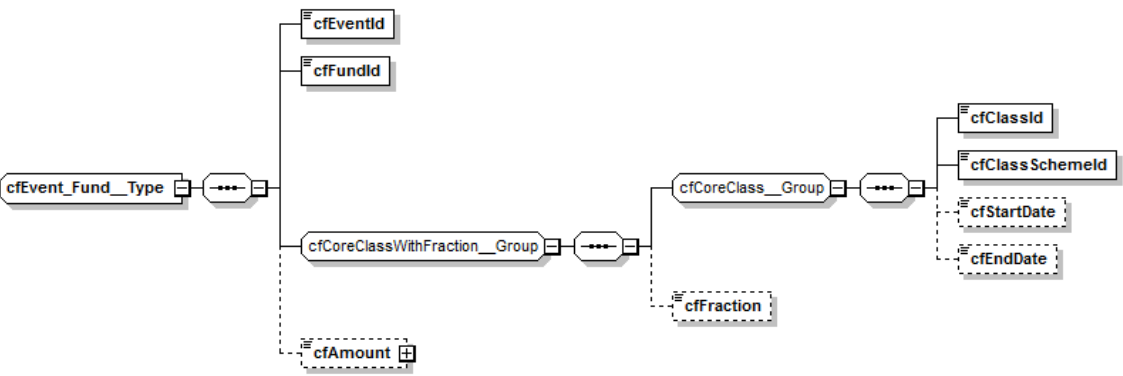
diagram	
namespace	urn:xmlns:org:eurocris:cerif-1.6-2
children	cfEventId cfFundId cfClassId cfClassSchemeld cfStartDate cfEndDate cfFraction cfAmount
used by	element CERIF/cfEvent_Fund
source	<pre><xs:complexType name="cfEvent_Fund_Type"> <xs:sequence> <xs:element name="cfEventId" type="cfId_Type"/> <xs:element name="cfFundId" type="cfId_Type"/> <xs:group ref="cfCoreClassWithFraction_Group"/> <xs:element name="cfAmount" type="cfAmount_Type" minOccurs="0"/> </xs:sequence> </xs:complexType></pre>

element **cfEvent_Fund_Type/cfEventId**

diagram	
namespace	urn:xmlns:org:eurocris:cerif-1.6-2
type	cfd_Type
properties	isRef 0 content simple
facets	Kind Value annotation maxLength 128
source	<code><xs:element name="cfEventId" type="cfd_Type"/></code>

element **cfEvent_Fund_Type/cfFundId**

diagram	
namespace	urn:xmlns:org:eurocris:cerif-1.6-2
type	cfd_Type
properties	isRef 0 content simple
facets	Kind Value annotation maxLength 128
source	<code><xs:element name="cfFundId" type="cfd_Type"/></code>

element **cfEvent_Fund_Type/cfAmount**

diagram													
namespace	urn:xmlns:org:eurocris:cerif-1.6-2												
type	cfAmount_Type												
properties	isRef 0 minOcc 0 maxOcc 1 content complex												
attributes	<table border="1"> <thead> <tr> <th>Name</th> <th>Type</th> <th>Use</th> <th>Default</th> <th>Fixed</th> <th>annotation</th> </tr> </thead> <tbody> <tr> <td>cfCurrCode</td> <td>xs:string</td> <td>required</td> <td></td> <td></td> <td></td> </tr> </tbody> </table>	Name	Type	Use	Default	Fixed	annotation	cfCurrCode	xs:string	required			
Name	Type	Use	Default	Fixed	annotation								
cfCurrCode	xs:string	required											
source	<code><xs:element name="cfAmount" type="cfAmount_Type" minOccurs="0"/></code>												

complexType **cfEvent_Indic_Type**

diagram	
namespace	urn:xmlns:org:eurocris:cerif-1.6-2

children	cfEventId cfIndicId cfClassId cfClassSchemeId cfStartDate cfEndDate cfFraction
used by	element CERIF/cfEvent_Indic
source	<pre><xs:complexType name="cfEvent_Indic__Type"> <xs:sequence> <xs:element name="cfEventId" type="cfd__Type"/> <xs:element name="cfIndicId" type="cfd__Type"/> <xs:group ref="cfCoreClassWithFraction__Group"/> </xs:sequence> </xs:complexType></pre>

element [cfEvent_Indic__Type/cfEventId](#)

diagram	
namespace	urn:xmlns:org:eurocris:cerif-1.6-2
type	cfd__Type
properties	isRef 0 content simple
facets	Kind Value annotation maxLength 128
source	<pre><xs:element name="cfEventId" type="cfd__Type"/></pre>

element [cfEvent_Indic__Type/cfIndicId](#)

diagram	
namespace	urn:xmlns:org:eurocris:cerif-1.6-2
type	cfd__Type
properties	isRef 0 content simple
facets	Kind Value annotation maxLength 128
source	<pre><xs:element name="cfIndicId" type="cfd__Type"/></pre>

complexType [cfEvent_Meas__Type](#)

diagram	
namespace	urn:xmlns:org:eurocris:cerif-1.6-2
children	cfEventId cfMeasId cfClassId cfClassSchemeId cfStartDate cfEndDate cfFraction
used by	element CERIF/cfEvent_Meas
source	<pre><xs:complexType name="cfEvent_Meas__Type"> <xs:sequence> <xs:element name="cfEventId" type="cfd__Type"/> <xs:element name="cfMeasId" type="cfd__Type"/> <xs:group ref="cfCoreClassWithFraction__Group"/> </xs:sequence></pre>

	<pre></xs:sequence> </xs:complexType></pre>
--	---

element **cfEvent_Meas__Type/cfEventId**

diagram	
namespace	urn.xmlns.org:eurocris:cerif-1.6-2
type	cfdl_Type
properties	isRef 0 content simple
facets	Kind Value annotation maxLength 128
source	<pre><xs:element name="cfEventId" type="cfdl_Type"/></pre>

element **cfEvent_Meas__Type/cfMeasId**

diagram	
namespace	urn.xmlns.org:eurocris:cerif-1.6-2
type	cfdl_Type
properties	isRef 0 content simple
facets	Kind Value annotation maxLength 128
source	<pre><xs:element name="cfMeasId" type="cfdl_Type"/></pre>

complexType **cfEventDescr__Type**

diagram	
namespace	urn.xmlns.org:eurocris:cerif-1.6-2
children	cfEventId cfDescr
used by	element CERIF/cfEventDescr
source	<pre><xs:complexType name="cfEventDescr__Type"> <xs:sequence> <xs:element name="cfEventId" type="cfdl_Type"/> <xs:element name="cfDescr" type="cfMLangString__Type"/> </xs:sequence> </xs:complexType></pre>

element **cfEventDescr__Type/cfEventId**

diagram	
namespace	urn.xmlns.org:eurocris:cerif-1.6-2
type	cfdl_Type
properties	isRef 0 content simple
facets	Kind Value annotation maxLength 128
source	<pre><xs:element name="cfEventId" type="cfdl_Type"/></pre>

element **cfEventDescr__Type/cfDescr**

diagram																			
namespace	urn:xmlns:org:eurocris:cerif-1.6-2																		
type	cfMLangString__Type																		
properties	isRef 0 content complex																		
attributes	<table border="1"> <thead> <tr> <th>Name</th> <th>Type</th> <th>Use</th> <th>Default</th> <th>Fixed</th> <th>annotation</th> </tr> </thead> <tbody> <tr> <td>cfLangCode</td> <td>xs:string</td> <td>required</td> <td></td> <td></td> <td></td> </tr> <tr> <td>cfTrans</td> <td>cfTrans__Type</td> <td>required</td> <td></td> <td></td> <td></td> </tr> </tbody> </table>	Name	Type	Use	Default	Fixed	annotation	cfLangCode	xs:string	required				cfTrans	cfTrans__Type	required			
Name	Type	Use	Default	Fixed	annotation														
cfLangCode	xs:string	required																	
cfTrans	cfTrans__Type	required																	
source	<code><xs:element name="cfDescr" type="cfMLangString__Type"/></code>																		

complexType **cfEventKeyw__Type**

diagram	
namespace	urn:xmlns:org:eurocris:cerif-1.6-2
children	cfEventId cfKeyw
used by	element CERIF/cfEventKeyw
source	<pre> <xs:complexType name="cfEventKeyw__Type"> <xs:sequence> <xs:element name="cfEventId" type="cfId__Type"/> <xs:element name="cfKeyw" type="cfMLangString__Type"/> </xs:sequence> </xs:complexType> </pre>

element **cfEventKeyw__Type/cfEventId**

diagram							
namespace	urn:xmlns:org:eurocris:cerif-1.6-2						
type	cfId__Type						
properties	isRef 0 content simple						
facets	<table border="1"> <thead> <tr> <th>Kind</th> <th>Value</th> <th>annotation</th> </tr> </thead> <tbody> <tr> <td>maxLength</td> <td>128</td> <td></td> </tr> </tbody> </table>	Kind	Value	annotation	maxLength	128	
Kind	Value	annotation					
maxLength	128						
source	<code><xs:element name="cfEventId" type="cfId__Type"/></code>						

element **cfEventKeyw__Type/cfKeyw**

diagram																			
namespace	urn:xmlns:org:eurocris:cerif-1.6-2																		
type	cfMLangString__Type																		
properties	isRef 0 content complex																		
attributes	<table border="1"> <thead> <tr> <th>Name</th> <th>Type</th> <th>Use</th> <th>Default</th> <th>Fixed</th> <th>annotation</th> </tr> </thead> <tbody> <tr> <td>cfLangCode</td> <td>xs:string</td> <td>required</td> <td></td> <td></td> <td></td> </tr> <tr> <td>cfTrans</td> <td>cfTrans__Type</td> <td>required</td> <td></td> <td></td> <td></td> </tr> </tbody> </table>	Name	Type	Use	Default	Fixed	annotation	cfLangCode	xs:string	required				cfTrans	cfTrans__Type	required			
Name	Type	Use	Default	Fixed	annotation														
cfLangCode	xs:string	required																	
cfTrans	cfTrans__Type	required																	
source	<code><xs:element name="cfKeyw" type="cfMLangString__Type"/></code>																		

complexType **cfEventName__Type**

diagram	
namespace	urn:xmlns:org:eurocris:cerif-1.6-2
children	cfEventId cfName
used by	element CERIF/cfEventName
source	<pre> <xs:complexType name="cfEventName__Type"> <xs:sequence> <xs:element name="cfEventId" type="cfId__Type"/> <xs:element name="cfName" type="cfMLangString__Type"/> </xs:sequence> </xs:complexType> </pre>

element **cfEventName__Type/cfEventId**

diagram							
namespace	urn:xmlns:org:eurocris:cerif-1.6-2						
type	cfId__Type						
properties	isRef 0 content simple						
facets	<table border="1"> <thead> <tr> <th>Kind</th> <th>Value</th> <th>annotation</th> </tr> </thead> <tbody> <tr> <td>maxLength</td> <td>128</td> <td></td> </tr> </tbody> </table>	Kind	Value	annotation	maxLength	128	
Kind	Value	annotation					
maxLength	128						
source	<code><xs:element name="cfEventId" type="cfId__Type"/></code>						

element **cfEventName__Type/cfName**

diagram																			
namespace	urn.xmlns:org:eurocris:cerif-1.6-2																		
type	cfMLangString__Type																		
properties	isRef 0 content complex																		
attributes	<table border="1"> <thead> <tr> <th>Name</th> <th>Type</th> <th>Use</th> <th>Default</th> <th>Fixed</th> <th>annotation</th> </tr> </thead> <tbody> <tr> <td>cfLangCode</td> <td>xs:string</td> <td>required</td> <td></td> <td></td> <td></td> </tr> <tr> <td>cfTrans</td> <td>cfTrans__Type</td> <td>required</td> <td></td> <td></td> <td></td> </tr> </tbody> </table>	Name	Type	Use	Default	Fixed	annotation	cfLangCode	xs:string	required				cfTrans	cfTrans__Type	required			
Name	Type	Use	Default	Fixed	annotation														
cfLangCode	xs:string	required																	
cfTrans	cfTrans__Type	required																	
source	<xs:element name="cfName" type="cfMLangString__Type"/>																		

complexType **cfFDCRightsMMPricing__Type**

diagram	
namespace	urn.xmlns:org:eurocris:cerif-1.6-2
children	cfDCId cfDCScheme cfDCLangTag cfFDCTrans cfFDCPriceConstraint
used by	element CERIF/cfFDCRightsMMPricing
source	<pre><xs:complexType name="cfFDCRightsMMPricing__Type"> <xs:sequence> <xs:element name="cfDCId" type="xs:string"/> <xs:element name="cfDCScheme" type="xs:string"/> <xs:element name="cfDCLangTag" type="xs:string"/> <xs:element name="cfFDCTrans" type="xs:string"/> <xs:element name="cfFDCPriceConstraint" type="xs:string" minOccurs="0"/> </xs:sequence> </xs:complexType></pre>

element **cfFDCRightsMMPricing__Type/cfDCId**

diagram	
namespace	urn.xmlns:org:eurocris:cerif-1.6-2
type	xs:string
properties	isRef 0 content simple
source	<xs:element name="cfDCId" type="xs:string"/>

element **cfFDCRightsMMPricing_Type/cfDCScheme**

diagram	
namespace	urn:xmlns:org:eurocris:cerif-1.6-2
type	xs:string
properties	isRef 0 content simple
source	<code><xs:element name="cfDCScheme" type="xs:string"/></code>

element **cfFDCRightsMMPricing_Type/cfDCLangTag**

diagram	
namespace	urn:xmlns:org:eurocris:cerif-1.6-2
type	xs:string
properties	isRef 0 content simple
source	<code><xs:element name="cfDCLangTag" type="xs:string"/></code>

element **cfFDCRightsMMPricing_Type/cfFDCTrans**

diagram	
namespace	urn:xmlns:org:eurocris:cerif-1.6-2
type	xs:string
properties	isRef 0 content simple
source	<code><xs:element name="cfFDCTrans" type="xs:string"/></code>

element **cfFDCRightsMMPricing_Type/cfFDCPriceConstraint**

diagram	
namespace	urn:xmlns:org:eurocris:cerif-1.6-2
type	xs:string
properties	isRef 0 minOcc 0 maxOcc 1 content simple
source	<code><xs:element name="cfFDCPriceConstraint" type="xs:string" minOccurs="0"/></code>

complexType **cfFDCRightsMMPrivacy_Type**

diagram	
namespace	urn:xmlns:org:eurocris:cerif-1.6-2

children	cfDCId cfDCScheme cfDCLangTag cfFDCTrans cfFDCPrivacyConstraint
used by	element CERIF/cfFDCRightsMMPrivacy
source	<pre><xs:complexType name="cfFDCRightsMMPrivacy__Type"> <xs:sequence> <xs:element name="cfDCId" type="xs:string"/> <xs:element name="cfDCScheme" type="xs:string"/> <xs:element name="cfDCLangTag" type="xs:string"/> <xs:element name="cfFDCTrans" type="xs:string"/> <xs:element name="cfFDCPrivacyConstraint" type="xs:string" minOccurs="0"/> </xs:sequence> </xs:complexType></pre>

element cfFDCRightsMMPrivacy__Type/cfDCId

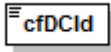
diagram	
namespace	urn:xmlns:org:eurocris:cerif-1.6-2
type	xs:string
properties	isRef 0 content simple
source	<pre><xs:element name="cfDCId" type="xs:string"/></pre>

element cfFDCRightsMMPrivacy__Type/cfDCScheme

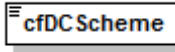
diagram	
namespace	urn:xmlns:org:eurocris:cerif-1.6-2
type	xs:string
properties	isRef 0 content simple
source	<pre><xs:element name="cfDCScheme" type="xs:string"/></pre>

element cfFDCRightsMMPrivacy__Type/cfDCLangTag

diagram	
namespace	urn:xmlns:org:eurocris:cerif-1.6-2
type	xs:string
properties	isRef 0 content simple
source	<pre><xs:element name="cfDCLangTag" type="xs:string"/></pre>

element cfFDCRightsMMPrivacy__Type/cfFDCTrans

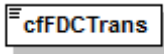
diagram	
namespace	urn:xmlns:org:eurocris:cerif-1.6-2
type	xs:string
properties	isRef 0 content simple
source	<pre><xs:element name="cfFDCTrans" type="xs:string"/></pre>

element cfFDCRightsMMPrivacy__Type/cfFDCPrivacyConstraint

diagram	
namespace	urn:xmlns:org:eurocris:cerif-1.6-2
type	xs:string
properties	isRef 0 minOcc 0 maxOcc 1 content simple
source	<xs:element name="cfFDCPrivacyConstraint" type="xs:string" minOccurs="0"/>

complexType cfFDCRightsMMRights__Type

diagram	
namespace	urn:xmlns:org:eurocris:cerif-1.6-2
children	cfDCId cfDCScheme cfDCLangTag cfDCTrans cfFDCRightsConstraint
used by	element CERIF/cfFDCRightsMMRights
source	<xs:complexType name="cfFDCRightsMMRights__Type"> <xs:sequence> <xs:element name="cfDCId" type="xs:string"/> <xs:element name="cfDCScheme" type="xs:string"/> <xs:element name="cfDCLangTag" type="xs:string"/> <xs:element name="cfDCTrans" type="xs:string"/> <xs:element name="cfFDCRightsConstraint" type="xs:string" minOccurs="0"/> </xs:sequence> </xs:complexType>

element cfFDCRightsMMRights__Type/cfDCId

diagram	
namespace	urn:xmlns:org:eurocris:cerif-1.6-2
type	xs:string
properties	isRef 0 content simple
source	<xs:element name="cfDCId" type="xs:string"/>

element cfFDCRightsMMRights__Type/cfDCScheme

diagram	
namespace	urn:xmlns:org:eurocris:cerif-1.6-2
type	xs:string
properties	isRef 0 content simple

source	<code><xs:element name="cfDCScheme" type="xs:string"/></code>
--------	---

element **cfFDCRightsMMRights__Type/cfDCLangTag**

diagram	
namespace	urn:xmlns:org:eurocris:cerif-1.6-2
type	xs:string
properties	isRef 0 content simple
source	<code><xs:element name="cfDCLangTag" type="xs:string"/></code>

element **cfFDCRightsMMRights__Type/cfDCTrans**

diagram	
namespace	urn:xmlns:org:eurocris:cerif-1.6-2
type	xs:string
properties	isRef 0 content simple
source	<code><xs:element name="cfDCTrans" type="xs:string"/></code>

element **cfFDCRightsMMRights__Type/cfFDCRightsConstraint**

diagram	
namespace	urn:xmlns:org:eurocris:cerif-1.6-2
type	xs:string
properties	isRef 0 minOcc 0 maxOcc 1 content simple
source	<code><xs:element name="cfFDCRightsConstraint" type="xs:string" minOccurs="0"/></code>

complexType **cfFDCRightsMMSecurity__Type**

diagram	
namespace	urn:xmlns:org:eurocris:cerif-1.6-2
children	cfDCId cfDCScheme cfDCLangTag cfDCTrans cfFDCSecurityConstraint
used by	element CERIF/cfFDCRightsMMSecurity
source	<code><xs:complexType name="cfFDCRightsMMSecurity__Type"> <xs:sequence> <xs:element name="cfDCId" type="xs:string"/> <xs:element name="cfDCScheme" type="xs:string"/> <xs:element name="cfDCLangTag" type="xs:string"/> <xs:element name="cfDCTrans" type="xs:string"/> </xs:sequence> </xs:complexType></code>

	<pre><xs:element name="cfFDCSecurityConstraint" type="xs:string" minOccurs="0"/> </xs:sequence> </xs:complexType></pre>
--	---

element **cfFDCRightsMMSecurity__Type/cfDCId**

diagram	
namespace	urn:xmlns:org:eurocris:cerif-1.6-2
type	xs:string
properties	isRef 0 content simple
source	<pre><xs:element name="cfDCId" type="xs:string"/></pre>

element **cfFDCRightsMMSecurity__Type/cfDCScheme**

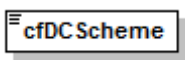
diagram	
namespace	urn:xmlns:org:eurocris:cerif-1.6-2
type	xs:string
properties	isRef 0 content simple
source	<pre><xs:element name="cfDCScheme" type="xs:string"/></pre>

element **cfFDCRightsMMSecurity__Type/cfDCLangTag**

diagram	
namespace	urn:xmlns:org:eurocris:cerif-1.6-2
type	xs:string
properties	isRef 0 content simple
source	<pre><xs:element name="cfDCLangTag" type="xs:string"/></pre>

element **cfFDCRightsMMSecurity__Type/cfFDCTrans**

diagram	
namespace	urn:xmlns:org:eurocris:cerif-1.6-2
type	xs:string
properties	isRef 0 content simple
source	<pre><xs:element name="cfFDCTrans" type="xs:string"/></pre>

element **cfFDCRightsMMSecurity__Type/cfFDCSecurityConstraint**

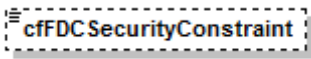
diagram	
namespace	urn:xmlns:org:eurocris:cerif-1.6-2
type	xs:string
properties	isRef 0 minOcc 0 maxOcc 1 content simple

source	<xs:element name="cfFDCSecurityConstraint" type="xs:string" minOccurs="0"/>
--------	---

complexType cfFedId_EmbType

diagram	
namespace	urn:xmlns:org:eurocris:cerif-1.6-2
children	cfFedIdId cfFedId cfClassId cfClassSchemeld cfStartDate cfEndDate cfFedId_Class
used by	elements cfClass_Type/cfFedId cfClassScheme_Type/cfFedId cfClassScheme_Type/cfClass/cfFedId cfLang_Type/cfFedId cfCountry_Type/cfFedId cfCV_Type/cfFedId cfEvent_Type/cfFedId cfFund_Type/cfFedId cfOrgUnit_Type/cfFedId cfPers_Type/cfFedId cfProj_Type/cfFedId cfResPubl_Type/cfFedId cfEAddr_Type/cfFedId cfPAddr_Type/cfFedId cfCurrency_Type/cfFedId cfDC_Type/cfFedId cfQual_Type/cfFedId cfCite_Type/cfFedId cfMetrics_Type/cfFedId cfMeas_Type/cfFedId cfIndic_Type/cfFedId
source	<pre><xs:complexType name="cfFedId_EmbType"> <xs:sequence> <xs:element name="cfFedIdId" type="cflD__Type" minOccurs="0"/> <xs:element name="cfFedId" type="xs:string"/> <xs:element name="cfClassId" type="cflD__Type" minOccurs="0"/> <xs:element name="cfClassSchemeld" type="cflD__Type" minOccurs="0"/> <xs:element name="cfStartDate" type="xs:dateTime" minOccurs="0"/> <xs:element name="cfEndDate" type="xs:dateTime" minOccurs="0"/> <xs:choice minOccurs="0" maxOccurs="unbounded"> <xs:element name="cfFedId_Class" type="cfCoreClassWithFraction__Type"/> </xs:choice> </xs:sequence> </xs:complexType></pre>

element cfFedId_EmbType/cfFedIdId

diagram									
namespace	urn:xmlns:org:eurocris:cerif-1.6-2								
type	cflD_Type								
properties	<table border="0"> <tr><td>isRef</td><td>0</td></tr> <tr><td>minOcc</td><td>0</td></tr> <tr><td>maxOcc</td><td>1</td></tr> <tr><td>content</td><td>simple</td></tr> </table>	isRef	0	minOcc	0	maxOcc	1	content	simple
isRef	0								
minOcc	0								
maxOcc	1								
content	simple								
facets	<table border="0"> <tr><td>Kind</td><td>Value</td><td>annotation</td></tr> <tr><td>maxLength</td><td>128</td><td></td></tr> </table>	Kind	Value	annotation	maxLength	128			
Kind	Value	annotation							
maxLength	128								
source	<xs:element name="cfFedIdId" type="cflD__Type" minOccurs="0"/>								

element **cfFedId**_EmbType/cfFedId

diagram	
namespace	urn:xmlns:org:eurocris:cerif-1.6-2
type	xs:string
properties	isRef 0 content simple
source	<code><xs:element name="cfFedId" type="xs:string"/></code>

element **cfFedId**_EmbType/cfClassId

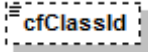
diagram	
namespace	urn:xmlns:org:eurocris:cerif-1.6-2
type	cfd_Type
properties	isRef 0 minOcc 0 maxOcc 1 content simple
facets	Kind Value annotation maxLength 128
source	<code><xs:element name="cfClassId" type="cfd_Type" minOccurs="0"/></code>

element **cfFedId**_EmbType/cfClassSchemeld

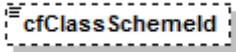
diagram	
namespace	urn:xmlns:org:eurocris:cerif-1.6-2
type	cfd_Type
properties	isRef 0 minOcc 0 maxOcc 1 content simple
facets	Kind Value annotation maxLength 128
source	<code><xs:element name="cfClassSchemeld" type="cfd_Type" minOccurs="0"/></code>

element **cfFedId**_EmbType/cfStartDate

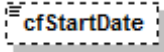
diagram	
namespace	urn:xmlns:org:eurocris:cerif-1.6-2
type	xs:dateTime
properties	isRef 0 minOcc 0 maxOcc 1 content simple
source	<code><xs:element name="cfStartDate" type="xs:dateTime" minOccurs="0"/></code>

element **cfFedId**_EmbType/cfEndDate

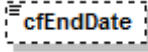
diagram	
namespace	urn:xmlns:org:eurocris:cerif-1.6-2
type	xs:dateTime

properties	isRef 0 minOcc 0 maxOcc 1 content simple
source	<xs:element name="cfEndDate" type="xs:dateTime" minOccurs="0"/>

element cfFedId_EmbType/cfFedId_Class

diagram	
namespace	urn:xmlns:org:eurocris:cerif-1.6-2
type	cfCoreClassWithFraction_Type
properties	isRef 0 content complex
children	cfClassId cfClassSchemeld cfStartDate cfEndDate cfFraction
source	<xs:element name="cfFedId_Class" type="cfCoreClassWithFraction_Type"/>

complexType cfFedId_Type

diagram	
namespace	urn:xmlns:org:eurocris:cerif-1.6-2
children	cfFedIdId cfInstId cfFedId cfClassId cfClassSchemeld cfStartDate cfEndDate cfFedId_Class cfFedId_Srv
used by	element CERIF/cfFedId
source	<pre><xs:complexType name="cfFedId_Type"> <xs:sequence> <xs:element name="cfFedIdId" type="cfId_Type" minOccurs="0"/> <xs:element name="cfInstId" type="cfId_Type"/> <xs:element name="cfFedId" type="xs:string"/> <xs:group ref="cfCoreClass_Group"/> <xs:choice minOccurs="0" maxOccurs="unbounded"> <!-- embedded linking entities --> <xs:element name="cfFedId_Class" type="cfCoreClassWithFraction_Type"/> </xs:choice> </xs:sequence> </xs:complexType></pre>

	<pre> <xs:element name="cfFedId_Srv"> <xs:complexType> <xs:sequence> <xs:element name="cfSrvId" type="cfd__Type"/> <xs:group ref="cfCoreClassWithFraction__Group"/> </xs:sequence> </xs:complexType> </xs:element> </xs:choice> </xs:sequence> </xs:complexType> </pre>
--	---

element **cfFedId__Type/cfFedIdId**

diagram	
namespace	urn:xmlns:org:eurocris:cerif-1.6-2
type	cfd__Type
properties	isRef 0 minOcc 0 maxOcc 1 content simple
facets	Kind Value annotation maxLength 128
source	<pre><xs:element name="cfFedIdId" type="cfd__Type" minOccurs="0"/></pre>

element **cfFedId__Type/cfInstId**

diagram	
namespace	urn:xmlns:org:eurocris:cerif-1.6-2
type	cfd__Type
properties	isRef 0 content simple
facets	Kind Value annotation maxLength 128
source	<pre><xs:element name="cfInstId" type="cfd__Type"/></pre>

element **cfFedId__Type/cfFedId**

diagram	
namespace	urn:xmlns:org:eurocris:cerif-1.6-2
type	xs:string
properties	isRef 0 content simple
source	<pre><xs:element name="cfFedId" type="xs:string"/></pre>

element **cfFedId__Type/cfFedId__Class**

diagram	
namespace	urn:xmlns:org:eurocris:cerif-1.6-2
type	cfCoreClassWithFraction__Type
properties	isRef 0 content complex
children	cfClassId cfClassSchemeld cfStartDate cfEndDate cfFraction
source	<code><xs:element name="cfFedId__Class" type="cfCoreClassWithFraction__Type"/></code>

element **cfFedId__Type/cfFedId__Srv**

diagram	
namespace	urn:xmlns:org:eurocris:cerif-1.6-2
properties	isRef 0 content complex
children	cfSrvId cfClassId cfClassSchemeld cfStartDate cfEndDate cfFraction
source	<pre> <xs:element name="cfFedId__Srv"> <xs:complexType> <xs:sequence> <xs:element name="cfSrvId" type="cfId__Type"/> <xs:group ref="cfCoreClassWithFraction__Group"/> </xs:sequence> </xs:complexType> </xs:element> </pre>

element **cfFedId__Type/cfFedId__Srv/cfSrvId**

diagram	
namespace	urn:xmlns:org:eurocris:cerif-1.6-2
type	cfId__Type
properties	isRef 0 content simple
facets	Kind Value annotation maxLength 128
source	<code><xs:element name="cfSrvId" type="cfId__Type"/></code>

complexType **cfFedId_Class_Type**

diagram	
namespace	urn:xmlns:org:eurocris:cerif-1.6-2
children	cfFedIdId cfClassId cfClassSchemeId cfStartDate cfEndDate cfFraction
used by	element CERIF/cfFedId_Class
source	<pre> <xs:complexType name="cfFedId_Class_Type"> <xs:sequence> <xs:element name="cfFedIdId" type="cfId__Type"/> <xs:group ref="cfCoreClassWithFraction_Group"/> </xs:sequence> </xs:complexType> </pre>

element **cfFedId_Class_Type/cfFedIdId**

diagram	
namespace	urn:xmlns:org:eurocris:cerif-1.6-2
type	cfId_Type
properties	isRef 0 content simple
facets	Kind Value annotation maxLength 128
source	<pre> <xs:element name="cfFedIdId" type="cfId__Type"/> </pre>

complexType cfFund__Type

diagram	
namespace	urn:xmlns:org:eurocris:cerif-1.6-2
children	cfFundId cfStartDate cfEndDate cfAcro cfAmount cfURI cfName cfDescr cfKeyw cfEvent_Fund cfFund_Class cfFund_Fund cfOrgUnit_Fund cfPers_Fund cfProj_Fund cfResPubl_Fund cfFund_Indic cfFund_Meas cfFedId
used by	element CERIF/cfFund
source	<pre> <xs:complexType name="cfFund__Type"> <xs:sequence> <xs:element name="cfFundId" type="cfId__Type"/> <xs:element name="cfStartDate" type="xs:date" minOccurs="0"/> <xs:element name="cfEndDate" type="xs:date" minOccurs="0"/> <xs:element name="cfAcro" type="xs:string" minOccurs="0"/> <xs:element name="cfAmount" type="cfAmount__Type" minOccurs="0"/> <xs:element name="cfURI" type="xs:string" minOccurs="0"/> <xs:choice minOccurs="0" maxOccurs="unbounded"> <!-- embedded multiple-language attributes --> <xs:element name="cfName" type="cfMLangString__Type"/> <xs:element name="cfDescr" type="cfMLangString__Type"/> <xs:element name="cfKeyw" type="cfMLangString__Type"/> <!-- embedded linking entities --> </pre>

```

<xs:element name="cfEvent_Fund">
  <xs:complexType>
    <xs:sequence>
      <xs:element name="cfEventId" type="cfId__Type"/>
      <xs:group ref="cfCoreClassWithFraction__Group"/>
      <xs:element name="cfAmount" type="cfAmount__Type" minOccurs="0"/>
    </xs:sequence>
  </xs:complexType>
</xs:element>
<xs:element name="cfFund_Class" type="cfCoreClassWithFraction__Type"/>
<xs:element name="cfFund_Fund">
  <xs:complexType>
    <xs:sequence>
      <xs:choice>
        <xs:element name="cfFundId2" type="cfId__Type"/>
        <xs:element name="cfFundId1" type="cfId__Type"/>
      </xs:choice>
      <xs:group ref="cfCoreClassWithFraction__Group"/>
    </xs:sequence>
  </xs:complexType>
</xs:element>
<xs:element name="cfOrgUnit_Fund">
  <xs:complexType>
    <xs:sequence>
      <xs:element name="cfOrgUnitId" type="cfId__Type"/>
      <xs:group ref="cfCoreClassWithFraction__Group"/>
      <xs:element name="cfAmount" type="cfAmount__Type" minOccurs="0"/>
    </xs:sequence>
  </xs:complexType>
</xs:element>
<xs:element name="cfPers_Fund">
  <xs:complexType>
    <xs:sequence>
      <xs:element name="cfPersId" type="cfId__Type"/>
      <xs:group ref="cfCoreClassWithFraction__Group"/>
      <xs:element name="cfAmount" type="cfAmount__Type" minOccurs="0"/>
    </xs:sequence>
  </xs:complexType>
</xs:element>
<xs:element name="cfProj_Fund">
  <xs:complexType>
    <xs:sequence>
      <xs:element name="cfProjId" type="cfId__Type"/>
      <xs:group ref="cfCoreClassWithFraction__Group"/>
      <xs:element name="cfAmount" type="cfAmount__Type" minOccurs="0"/>
    </xs:sequence>
  </xs:complexType>
</xs:element>
<xs:element name="cfResPubl_Fund">
  <xs:complexType>
    <xs:sequence>
      <xs:element name="cfResPublId" type="cfId__Type"/>
      <xs:group ref="cfCoreClassWithFraction__Group"/>
      <xs:element name="cfAmount" type="cfAmount__Type" minOccurs="0"/>
    </xs:sequence>
  </xs:complexType>
</xs:element>
<xs:element name="cfFund_Indic">
  <xs:complexType>
    <xs:sequence>
      <xs:element name="cfIndicId" type="cfId__Type"/>
      <xs:group ref="cfCoreClassWithFraction__Group"/>
    </xs:sequence>
  </xs:complexType>

```

	<pre> <xs:element name="cfAmount" type="cfAmount__Type" minOccurs="0"/> </xs:sequence> </xs:complexType> </xs:element> <xs:element name="cfFund_Meas"> <xs:complexType> <xs:sequence> <xs:element name="cfMeasId" type="cfId__Type"/> <xs:group ref="cfCoreClassWithFraction__Group"/> <xs:element name="cfAmount" type="cfAmount__Type" minOccurs="0"/> </xs:sequence> </xs:complexType> </xs:element> <!-- embedded federated identifiers --> <xs:element name="cfFedId" type="cfFedId__EmbType"/> </xs:choice> </xs:sequence> </xs:complexType> </pre>
--	---

element **cfFund__Type/cfFundId**

diagram	
namespace	urn:xmlns:org:eurocris:cerif-1.6-2
type	cfId__Type
properties	isRef 0 content simple
facets	Kind Value annotation maxLength 128
source	<pre><xs:element name="cfFundId" type="cfId__Type"/></pre>

element **cfFund__Type/cfStartDate**

diagram	
namespace	urn:xmlns:org:eurocris:cerif-1.6-2
type	xs:date
properties	isRef 0 minOcc 0 maxOcc 1 content simple
source	<pre><xs:element name="cfStartDate" type="xs:date" minOccurs="0"/></pre>

element **cfFund__Type/cfEndDate**

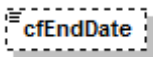
diagram	
namespace	urn:xmlns:org:eurocris:cerif-1.6-2
type	xs:date
properties	isRef 0 minOcc 0 maxOcc 1 content simple
source	<pre><xs:element name="cfEndDate" type="xs:date" minOccurs="0"/></pre>

element cfFund__Type/cfAcro

diagram	
namespace	urn:xmlns:org:eurocris:cerif-1.6-2
type	xs:string
properties	isRef 0 minOcc 0 maxOcc 1 content simple
source	<xs:element name="cfAcro" type="xs:string" minOccurs="0"/>

element cfFund__Type/cfAmount

diagram													
namespace	urn:xmlns:org:eurocris:cerif-1.6-2												
type	<u>cfAmount__Type</u>												
properties	isRef 0 minOcc 0 maxOcc 1 content complex												
attributes	<table border="1"> <thead> <tr> <th>Name</th> <th>Type</th> <th>Use</th> <th>Default</th> <th>Fixed</th> <th>annotation</th> </tr> </thead> <tbody> <tr> <td><u>cfCurrCode</u></td> <td>xs:string</td> <td>required</td> <td></td> <td></td> <td></td> </tr> </tbody> </table>	Name	Type	Use	Default	Fixed	annotation	<u>cfCurrCode</u>	xs:string	required			
Name	Type	Use	Default	Fixed	annotation								
<u>cfCurrCode</u>	xs:string	required											
source	<xs:element name="cfAmount" type="cfAmount__Type" minOccurs="0"/>												

element cfFund__Type/cfURI

diagram	
namespace	urn:xmlns:org:eurocris:cerif-1.6-2
type	xs:string
properties	isRef 0 minOcc 0 maxOcc 1 content simple
source	<xs:element name="cfURI" type="xs:string" minOccurs="0"/>

element cfFund__Type/cfName

diagram	
namespace	urn:xmlns:org:eurocris:cerif-1.6-2
type	<u>cfMLangString__Type</u>

properties	isRef 0 content complex					
attributes	Name cfLangCode	Type xs:string	Use required	Default	Fixed	annotation
	cfTrans	cfTrans_Type	required			
source	<code><xs:element name="cfName" type="cfMLangString__Type"/></code>					

element cfFund__Type/cfDescr

diagram						
namespace	urn:xmlns:org:eurocris:cerif-1.6-2					
type	cfMLangString_Type					
properties	isRef 0 content complex					
attributes	Name cfLangCode	Type xs:string	Use required	Default	Fixed	annotation
	cfTrans	cfTrans_Type	required			
source	<code><xs:element name="cfDescr" type="cfMLangString__Type"/></code>					

element cfFund__Type/cfKeyw

diagram						
namespace	urn:xmlns:org:eurocris:cerif-1.6-2					
type	cfMLangString_Type					
properties	isRef 0 content complex					
attributes	Name cfLangCode	Type xs:string	Use required	Default	Fixed	annotation
	cfTrans	cfTrans_Type	required			
source	<code><xs:element name="cfKeyw" type="cfMLangString__Type"/></code>					

element cfFund_Type/cfEvent_Fund

diagram	
namespace	urn:xmlns:org:eurocris:cerif-1.6-2
properties	isRef 0 content complex
children	cfEventId cfClassId cfClassSchemeId cfStartDate cfEndDate cfFraction cfAmount
source	<pre> <xs:element name="cfEvent_Fund"> <xs:complexType> <xs:sequence> <xs:element name="cfEventId" type="cfId__Type"/> <xs:group ref="cfCoreClassWithFraction__Group"/> <xs:element name="cfAmount" type="cfAmount__Type" minOccurs="0"/> </xs:sequence> </xs:complexType> </xs:element> </pre>

element cfFund_Type/cfEvent_Fund/cfEventId

diagram	
namespace	urn:xmlns:org:eurocris:cerif-1.6-2
type	cfId_Type
properties	isRef 0 content simple
facets	Kind Value annotation maxLength 128
source	<pre><xs:element name="cfEventId" type="cfId__Type"/></pre>

element cfFund_Type/cfEvent_Fund/cfAmount

diagram													
namespace	urn:xmlns:org:eurocris:cerif-1.6-2												
type	cfAmount_Type												
properties	isRef 0 minOcc 0 maxOcc 1 content complex												
attributes	<table border="1"> <thead> <tr> <th>Name</th> <th>Type</th> <th>Use</th> <th>Default</th> <th>Fixed</th> <th>annotation</th> </tr> </thead> <tbody> <tr> <td>cfCurrCode</td> <td>xs:string</td> <td>required</td> <td></td> <td></td> <td></td> </tr> </tbody> </table>	Name	Type	Use	Default	Fixed	annotation	cfCurrCode	xs:string	required			
Name	Type	Use	Default	Fixed	annotation								
cfCurrCode	xs:string	required											

source	<xs:element name="cfAmount" type="cfAmount__Type" minOccurs="0"/>
--------	---

element cfFund__Type/cfFund_Class

diagram	
namespace	urn:xmlns:org:eurocris:cerif-1.6-2
type	cfCoreClassWithFraction__Type
properties	isRef 0 content complex
children	cfClassId cfClassSchemeld cfStartDate cfEndDate cfFraction
source	<xs:element name="cfFund_Class" type="cfCoreClassWithFraction__Type"/>

element cfFund__Type/cfFund_Fund

diagram	
namespace	urn:xmlns:org:eurocris:cerif-1.6-2
properties	isRef 0 content complex
children	cfFundId2 cfFundId1 cfClassId cfClassSchemeld cfStartDate cfEndDate cfFraction
source	<pre> <xs:element name="cfFund_Fund"> <xs:complexType> <xs:sequence> <xs:choice> <xs:element name="cfFundId2" type="cflD__Type"/> <xs:element name="cfFundId1" type="cflD__Type"/> </xs:choice> <xs:group ref="cfCoreClassWithFraction__Group"/> </xs:sequence> </xs:complexType> </xs:element> </pre>

element cfFund__Type/cfFund_Fund/cfFundId2

diagram	
namespace	urn:xmlns:org:eurocris:cerif-1.6-2
type	cflD__Type

properties	isRef 0 content simple
facets	Kind Value annotation maxLength 128
source	<xs:element name="cfFundId2" type="cfId__Type"/>

element cfFund__Type/cfFund_Fund/cfFundId1

diagram	
namespace	urn:xmlns:org:eurocris:cerif-1.6-2
type	cfId__Type
properties	isRef 0 content simple
facets	Kind Value annotation maxLength 128
source	<xs:element name="cfFundId1" type="cfId__Type"/>

element cfFund__Type/cfOrgUnit_Fund

diagram	
namespace	urn:xmlns:org:eurocris:cerif-1.6-2
properties	isRef 0 content complex
children	cfOrgUnitId cfClassId cfClassSchemeld cfStartDate cfEndDate cfFraction cfAmount
source	<xs:element name="cfOrgUnit_Fund"> <xs:complexType> <xs:sequence> <xs:element name="cfOrgUnitId" type="cfId__Type"/> <xs:group ref="cfCoreClassWithFraction_Group"/> <xs:element name="cfAmount" type="cfAmount__Type" minOccurs="0"/> </xs:sequence> </xs:complexType> </xs:element>

element cfFund__Type/cfOrgUnit_Fund/cfOrgUnitId

diagram	
namespace	urn:xmlns:org:eurocris:cerif-1.6-2
type	cfId__Type
properties	isRef 0 content simple
facets	Kind Value annotation maxLength 128
source	<xs:element name="cfOrgUnitId" type="cfId__Type"/>

element **cfFund__Type/cfOrgUnit_Fund/cfAmount**

diagram						
namespace	urn:xmlns:org:eurocris:cerif-1.6-2					
type	cfAmount__Type					
properties	isRef	0	minOcc	0	maxOcc	1
	content	complex				
attributes	Name	Type	Use	Default	Fixed	annotation
	cfCurrCode	xs:string	required			
source	<code><xs:element name="cfAmount" type="cfAmount__Type" minOccurs="0"/></code>					

element **cfFund__Type/cfPers_Fund**

diagram						
namespace	urn:xmlns:org:eurocris:cerif-1.6-2					
properties	isRef	0	content	complex		
children	cfPersId cfClassId cfClassSchemeld cfStartDate cfEndDate cfFraction cfAmount					
source	<pre> <xs:element name="cfPers_Fund"> <xs:complexType> <xs:sequence> <xs:element name="cfPersId" type="cfId__Type"/> <xs:group ref="cfCoreClassWithFraction_Group"/> <xs:element name="cfAmount" type="cfAmount__Type" minOccurs="0"/> </xs:sequence> </xs:complexType> </xs:element> </pre>					

element **cfFund__Type/cfPers_Fund/cfPersId**

diagram						
namespace	urn:xmlns:org:eurocris:cerif-1.6-2					
type	cfId__Type					
properties	isRef	0	content	simple		
facets	Kind	Value	annotation			
	maxLength	128				

source	<xs:element name="cfPersId" type="cfId__Type"/>
--------	---

element cfFund__Type/cfPers_Fund/cfAmount

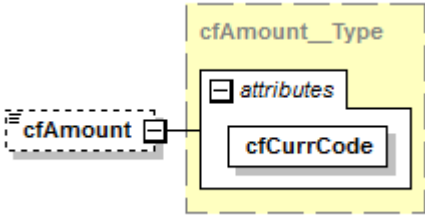
diagram													
namespace	urn:xmlns:org:eurocris:cerif-1.6-2												
type	cfAmount_Type												
properties	isRef 0 minOcc 0 maxOcc 1 content complex												
attributes	<table border="1"> <thead> <tr> <th>Name</th> <th>Type</th> <th>Use</th> <th>Default</th> <th>Fixed</th> <th>annotation</th> </tr> </thead> <tbody> <tr> <td>cfCurrCode</td> <td>xs:string</td> <td>required</td> <td></td> <td></td> <td></td> </tr> </tbody> </table>	Name	Type	Use	Default	Fixed	annotation	cfCurrCode	xs:string	required			
Name	Type	Use	Default	Fixed	annotation								
cfCurrCode	xs:string	required											
source	<xs:element name="cfAmount" type="cfAmount__Type" minOccurs="0"/>												

element cfFund__Type/cfProj_Fund

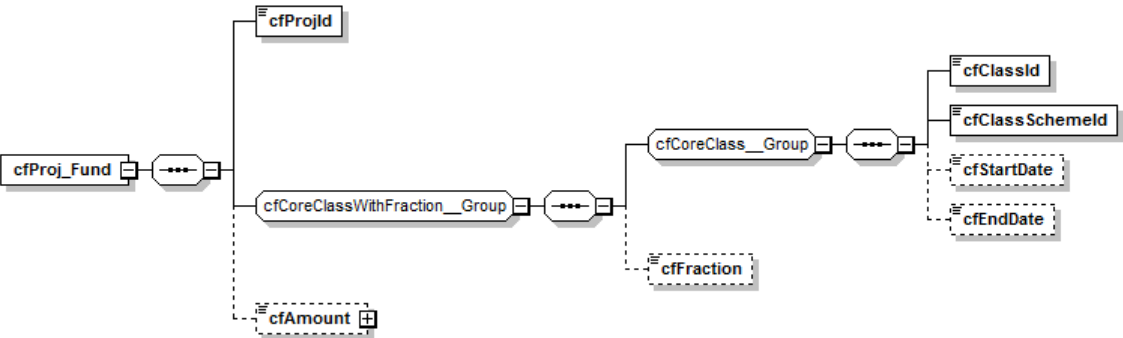
diagram	
namespace	urn:xmlns:org:eurocris:cerif-1.6-2
properties	isRef 0 content complex
children	cfProjId cfClassId cfClassSchemeld cfStartDate cfEndDate cfFraction cfAmount
source	<pre> <xs:element name="cfProj_Fund"> <xs:complexType> <xs:sequence> <xs:element name="cfProjId" type="cfId__Type"/> <xs:group ref="cfCoreClassWithFraction__Group"/> <xs:element name="cfAmount" type="cfAmount__Type" minOccurs="0"/> </xs:sequence> </xs:complexType> </xs:element> </pre>

element cfFund__Type/cfProj_Fund/cfProjId

diagram	
namespace	urn:xmlns:org:eurocris:cerif-1.6-2
type	cfId_Type
properties	isRef 0 content simple

facets	Kind maxLength	Value 128	annotation
source	<code><xs:element name="cfProjId" type="cfId__Type"/></code>		

element cfFund__Type/cfProj_Fund/cfAmount

diagram						
namespace	urn.xmlns:org:eurocris:cerif-1.6-2					
type	cfAmount__Type					
properties	isRef	0	minOcc	0	maxOcc	1
	content	complex				
attributes	Name	Type	Use	Default	Fixed	annotation
	cfCurrCode	xs:string	required			
source	<code><xs:element name="cfAmount" type="cfAmount__Type" minOccurs="0"/></code>					

element cfFund__Type/cfResPubl_Fund

diagram						
namespace	urn.xmlns:org:eurocris:cerif-1.6-2					
properties	isRef	0	content	complex		
children	cfResPublId cfClassId cfClassSchemeld cfStartDate cfEndDate cfFraction cfAmount					
source	<pre> <xs:element name="cfResPubl_Fund"> <xs:complexType> <xs:sequence> <xs:element name="cfResPublId" type="cfId__Type"/> <xs:group ref="cfCoreClassWithFraction_Group"/> <xs:element name="cfAmount" type="cfAmount__Type" minOccurs="0"/> </xs:sequence> </xs:complexType> </xs:element> </pre>					

element cfFund__Type/cfResPubl_Fund/cfResPublId

diagram						
namespace	urn.xmlns:org:eurocris:cerif-1.6-2					
type	cfId__Type					

properties	isRef 0 content simple
facets	Kind Value annotation maxLength 128
source	<xs:element name="cfResPublId" type="cfId__Type"/>

element cfFund__Type/cfResPubl_Fund/cfAmount

diagram													
namespace	urn:xmlns:org:eurocris:cerif-1.6-2												
type	cfAmount__Type												
properties	isRef 0 minOcc 0 maxOcc 1 content complex												
attributes	<table border="1"> <thead> <tr> <th>Name</th> <th>Type</th> <th>Use</th> <th>Default</th> <th>Fixed</th> <th>annotation</th> </tr> </thead> <tbody> <tr> <td>cfCurrCode</td> <td>xs:string</td> <td>required</td> <td></td> <td></td> <td></td> </tr> </tbody> </table>	Name	Type	Use	Default	Fixed	annotation	cfCurrCode	xs:string	required			
Name	Type	Use	Default	Fixed	annotation								
cfCurrCode	xs:string	required											
source	<xs:element name="cfAmount" type="cfAmount__Type" minOccurs="0"/>												

element cfFund__Type/cfFund_Indic

diagram	
namespace	urn:xmlns:org:eurocris:cerif-1.6-2
properties	isRef 0 content complex
children	cfIndicId cfClassId cfClassSchemeld cfStartDate cfEndDate cfFraction cfAmount
source	<pre> <xs:element name="cfFund_Indic"> <xs:complexType> <xs:sequence> <xs:element name="cfIndicId" type="cfId__Type"/> <xs:group ref="cfCoreClassWithFraction__Group"/> <xs:element name="cfAmount" type="cfAmount__Type" minOccurs="0"/> </xs:sequence> </xs:complexType> </xs:element> </pre>

element cfFund__Type/cfFund_Indic/cfIndicId

diagram	
---------	--

namespace	urn:xmlns:org:eurocris:cerif-1.6-2
type	cflD_Type
properties	isRef 0 content simple
facets	Kind Value annotation maxLength 128
source	<code><xs:element name="cfIndicId" type="cflD_Type"/></code>

element cfFund_Type/cfFund_Indic/cfAmount

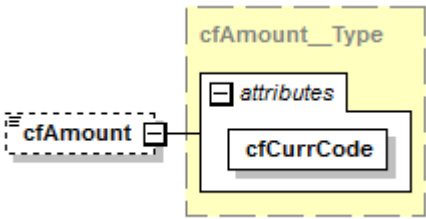
diagram													
namespace	urn:xmlns:org:eurocris:cerif-1.6-2												
type	cfAmount_Type												
properties	isRef 0 minOcc 0 maxOcc 1 content complex												
attributes	<table border="1"> <thead> <tr> <th>Name</th> <th>Type</th> <th>Use</th> <th>Default</th> <th>Fixed</th> <th>annotation</th> </tr> </thead> <tbody> <tr> <td>cfCurrCode</td> <td>xs:string</td> <td>required</td> <td></td> <td></td> <td></td> </tr> </tbody> </table>	Name	Type	Use	Default	Fixed	annotation	cfCurrCode	xs:string	required			
Name	Type	Use	Default	Fixed	annotation								
cfCurrCode	xs:string	required											
source	<code><xs:element name="cfAmount" type="cfAmount_Type" minOccurs="0"/></code>												

element cfFund_Type/cfFund_Meas

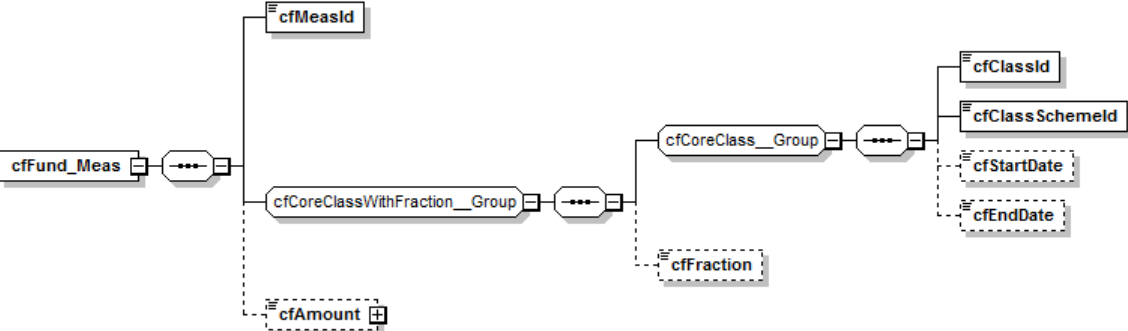
diagram	
namespace	urn:xmlns:org:eurocris:cerif-1.6-2
properties	isRef 0 content complex
children	cfMeasId cfClassId cfClassSchemeId cfStartDate cfEndDate cfFraction cfAmount
source	<pre> <xs:element name="cfFund_Meas"> <xs:complexType> <xs:sequence> <xs:element name="cfMeasId" type="cflD_Type"/> <xs:group ref="cfCoreClassWithFraction_Group"/> <xs:element name="cfAmount" type="cfAmount_Type" minOccurs="0"/> </xs:sequence> </xs:complexType> </xs:element> </pre>

element **cfFund_Type/cfFund_Meas/cfMeasId**

diagram	
namespace	urn:xmlns:org:eurocris:cerif-1.6-2
type	cfd_Type
properties	isRef 0 content simple
facets	Kind Value annotation maxLength 128
source	<code><xs:element name="cfMeasId" type="cfd_Type"/></code>

element **cfFund_Type/cfFund_Meas/cfAmount**

diagram													
namespace	urn:xmlns:org:eurocris:cerif-1.6-2												
type	cfAmount_Type												
properties	isRef 0 minOcc 0 maxOcc 1 content complex												
attributes	<table border="1"> <thead> <tr> <th>Name</th> <th>Type</th> <th>Use</th> <th>Default</th> <th>Fixed</th> <th>annotation</th> </tr> </thead> <tbody> <tr> <td>cfCurrCode</td> <td>xs:string</td> <td>required</td> <td></td> <td></td> <td></td> </tr> </tbody> </table>	Name	Type	Use	Default	Fixed	annotation	cfCurrCode	xs:string	required			
Name	Type	Use	Default	Fixed	annotation								
cfCurrCode	xs:string	required											
source	<code><xs:element name="cfAmount" type="cfAmount_Type" minOccurs="0"/></code>												

element **cfFund_Type/cfFedId**

diagram	
namespace	urn:xmlns:org:eurocris:cerif-1.6-2
type	cfFedId_EmbType
properties	isRef 0 content complex
children	cfFedIdId cfFedId cfClassId cfClassSchemeld cfStartDate cfEndDate cfFedId_Class

source	<code><xs:element name="cfFundId" type="cfFundId__EmbType"/></code>
--------	---

complexType cfFund_Class_Type

diagram	
namespace	urn:xmlns:org:eurocris:cerif-1.6-2
children	cfFundId cfClassId cfClassSchemeld cfStartDate cfEndDate cfFraction
used by	element CERIF/cfFund_Class
source	<pre><xs:complexType name="cfFund_Class_Type"> <xs:sequence> <xs:element name="cfFundId" type="cfId__Type"/> <xs:group ref="cfCoreClassWithFraction_Group"/> </xs:sequence> </xs:complexType></pre>

element cfFund_Class_Type/cfFundId

diagram	
namespace	urn:xmlns:org:eurocris:cerif-1.6-2
type	cfId_Type
properties	isRef 0 content simple
facets	Kind Value annotation maxLength 128
source	<code><xs:element name="cfFundId" type="cfId__Type"/></code>

complexType cfFund_Fund_Type

diagram	
namespace	urn:xmlns:org:eurocris:cerif-1.6-2
children	cfFundId1 cfFundId2 cfClassId cfClassSchemeld cfStartDate cfEndDate cfFraction
used by	element CERIF/cfFund_Fund
source	<pre><xs:complexType name="cfFund_Fund_Type"> <xs:sequence> <xs:element name="cfFundId1" type="cfId__Type"/> </xs:sequence> </xs:complexType></pre>

	<pre><xs:element name="cfFundId2" type="cfd__Type"/> <xs:group ref="cfCoreClassWithFraction__Group"/> </xs:sequence> </xs:complexType></pre>
--	--

element cfFund_Fund_Type/cfFundId1

diagram	
namespace	urn:xmlns:org:eurocris:cerif-1.6-2
type	cfd__Type
properties	isRef 0 content simple
facets	Kind Value annotation maxLength 128
source	<pre><xs:element name="cfFundId1" type="cfd__Type"/></pre>

element cfFund_Fund_Type/cfFundId2

diagram	
namespace	urn:xmlns:org:eurocris:cerif-1.6-2
type	cfd__Type
properties	isRef 0 content simple
facets	Kind Value annotation maxLength 128
source	<pre><xs:element name="cfFundId2" type="cfd__Type"/></pre>

complexType cfFund_Indic_Type

diagram	
namespace	urn:xmlns:org:eurocris:cerif-1.6-2
children	cfFundId cfIndicId cfClassSchemeld cfStartDate cfEndDate cfFraction cfAmount cfClassId
used by	element CERIF/cfFund_Indic
source	<pre><xs:complexType name="cfFund_Indic__Type"> <xs:sequence> <xs:element name="cfFundId" type="cfd__Type"/> <xs:element name="cfIndicId" type="cfd__Type"/> <xs:element name="cfClassSchemeld" type="cfd__Type"/></pre>

	<pre> <xs:element name="cfStartDate" type="xs:dateTime" minOccurs="0"/> <xs:element name="cfEndDate" type="xs:dateTime" minOccurs="0"/> <xs:element name="cfFraction" type="xs:float" minOccurs="0"/> <xs:element name="cfAmount" type="cfAmount__Type" minOccurs="0"/> <xs:element name="cfClassId" type="cfId__Type"/> </xs:sequence> </xs:complexType> </pre>
--	--

element cfFund_Indic__Type/cfFundId

diagram	
namespace	urn:xmlns:org:eurocris:cerif-1.6-2
type	cfId__Type
properties	isRef 0 content simple
facets	Kind Value annotation maxLength 128
source	<pre><xs:element name="cfFundId" type="cfId__Type"/></pre>

element cfFund_Indic__Type/cfIndicId

diagram	
namespace	urn:xmlns:org:eurocris:cerif-1.6-2
type	cfId__Type
properties	isRef 0 content simple
facets	Kind Value annotation maxLength 128
source	<pre><xs:element name="cfIndicId" type="cfId__Type"/></pre>

element cfFund_Indic__Type/cfClassSchemeld

diagram	
namespace	urn:xmlns:org:eurocris:cerif-1.6-2
type	cfId__Type
properties	isRef 0 content simple
facets	Kind Value annotation maxLength 128
source	<pre><xs:element name="cfClassSchemeld" type="cfId__Type"/></pre>

element cfFund_Indic__Type/cfStartDate

diagram	
namespace	urn:xmlns:org:eurocris:cerif-1.6-2
type	xs:dateTime
properties	isRef 0 minOcc 0 maxOcc 1 content simple
source	<pre><xs:element name="cfStartDate" type="xs:dateTime" minOccurs="0"/></pre>

element **cfFund_Indic_Type/cfEndDate**

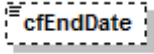
diagram	
namespace	urn:xmlns:org:eurocris:cerif-1.6-2
type	xs:dateTime
properties	isRef 0 minOcc 0 maxOcc 1 content simple
source	<code><xs:element name="cfEndDate" type="xs:dateTime" minOccurs="0"/></code>

element **cfFund_Indic_Type/cfFraction**

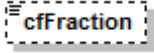
diagram	
namespace	urn:xmlns:org:eurocris:cerif-1.6-2
type	xs:float
properties	isRef 0 minOcc 0 maxOcc 1 content simple
source	<code><xs:element name="cfFraction" type="xs:float" minOccurs="0"/></code>

element **cfFund_Indic_Type/cfAmount**

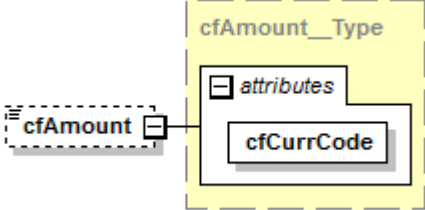
diagram													
namespace	urn:xmlns:org:eurocris:cerif-1.6-2												
type	cfAmount_Type												
properties	isRef 0 minOcc 0 maxOcc 1 content complex												
attributes	<table border="1"> <thead> <tr> <th>Name</th> <th>Type</th> <th>Use</th> <th>Default</th> <th>Fixed</th> <th>annotation</th> </tr> </thead> <tbody> <tr> <td>cfCurrCode</td> <td>xs:string</td> <td>required</td> <td></td> <td></td> <td></td> </tr> </tbody> </table>	Name	Type	Use	Default	Fixed	annotation	cfCurrCode	xs:string	required			
Name	Type	Use	Default	Fixed	annotation								
cfCurrCode	xs:string	required											
source	<code><xs:element name="cfAmount" type="cfAmount_Type" minOccurs="0"/></code>												

element **cfFund_Indic_Type/cfClassId**

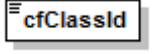
diagram							
namespace	urn:xmlns:org:eurocris:cerif-1.6-2						
type	cfld_Type						
properties	isRef 0 content simple						
facets	<table border="1"> <thead> <tr> <th>Kind</th> <th>Value</th> <th>annotation</th> </tr> </thead> <tbody> <tr> <td>maxLength</td> <td>128</td> <td></td> </tr> </tbody> </table>	Kind	Value	annotation	maxLength	128	
Kind	Value	annotation					
maxLength	128						
source	<code><xs:element name="cfClassId" type="cfld_Type"/></code>						

complexType **cfFund_Meas_Type**

diagram	
namespace	urn:xmlns:org:eurocris:cerif-1.6-2
children	cfFundId cfMeasId cfClassSchemeld cfStartDate cfEndDate cfFraction cfAmount cfClassId
used by	element CERIF/cfFund_Meas
source	<pre> <xs:complexType name="cfFund_Meas_Type"> <xs:sequence> <xs:element name="cfFundId" type="cfId__Type"/> <xs:element name="cfMeasId" type="cfId__Type"/> <xs:element name="cfClassSchemeld" type="cfId__Type"/> <xs:element name="cfStartDate" type="xs:dateTime" minOccurs="0"/> <xs:element name="cfEndDate" type="xs:dateTime" minOccurs="0"/> <xs:element name="cfFraction" type="xs:float" minOccurs="0"/> <xs:element name="cfAmount" type="cfAmount__Type" minOccurs="0"/> <xs:element name="cfClassId" type="cfId__Type"/> </xs:sequence> </xs:complexType> </pre>

element **cfFund_Meas_Type/cfFundId**

diagram	
namespace	urn:xmlns:org:eurocris:cerif-1.6-2
type	cfId_Type
properties	isRef 0 content simple
facets	Kind Value annotation maxLength 128
source	<pre><xs:element name="cfFundId" type="cfId__Type"/></pre>

element **cfFund_Meas_Type/cfMeasId**

diagram	
namespace	urn:xmlns:org:eurocris:cerif-1.6-2
type	cfId_Type
properties	isRef 0 content simple
facets	Kind Value annotation

	maxLength 128
source	<code><xs:element name="cfMeasId" type="cfd__Type"/></code>

element cfFund_Meas_Type/cfClassSchemeld

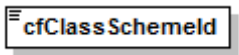
diagram	
namespace	urn:xmlns:org:eurocris:cerif-1.6-2
type	cfd_Type
properties	isRef 0 content simple
facets	Kind Value annotation maxLength 128
source	<code><xs:element name="cfClassSchemeld" type="cfd__Type"/></code>

element cfFund_Meas_Type/cfStartDate

diagram	
namespace	urn:xmlns:org:eurocris:cerif-1.6-2
type	xs:dateTime
properties	isRef 0 minOcc 0 maxOcc 1 content simple
source	<code><xs:element name="cfStartDate" type="xs:dateTime" minOccurs="0"/></code>

element cfFund_Meas_Type/cfEndDate

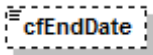
diagram	
namespace	urn:xmlns:org:eurocris:cerif-1.6-2
type	xs:dateTime
properties	isRef 0 minOcc 0 maxOcc 1 content simple
source	<code><xs:element name="cfEndDate" type="xs:dateTime" minOccurs="0"/></code>

element cfFund_Meas_Type/cfFraction

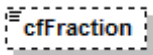
diagram	
namespace	urn:xmlns:org:eurocris:cerif-1.6-2
type	xs:float
properties	isRef 0 minOcc 0 maxOcc 1 content simple
source	<code><xs:element name="cfFraction" type="xs:float" minOccurs="0"/></code>

element **cfFund_Meas__Type/cfAmount**

diagram						
namespace	urn:xmlns:org:eurocris:cerif-1.6-2					
type	cfAmount__Type					
properties	isRef	0	minOcc	0	maxOcc	1
	content	complex				
attributes	Name	Type	Use	Default	Fixed	annotation
	cfCurrCode	xs:string	required			
source	<code><xs:element name="cfAmount" type="cfAmount__Type" minOccurs="0"/></code>					

element **cfFund_Meas__Type/cfClassId**

diagram						
namespace	urn:xmlns:org:eurocris:cerif-1.6-2					
type	cfId__Type					
properties	isRef	0	content	simple		
facets	Kind	Value	annotation			
	maxLength	128				
source	<code><xs:element name="cfClassId" type="cfId__Type"/></code>					

complexType **cfFundDescr__Type**

diagram						
namespace	urn:xmlns:org:eurocris:cerif-1.6-2					
children	cfFundId cfDescr					
used by	element	CERIF/cfFundDescr				
source	<pre> <xs:complexType name="cfFundDescr__Type"> <xs:sequence> <xs:element name="cfFundId" type="cfId__Type"/> <xs:element name="cfDescr" type="cfMLangString__Type"/> </xs:sequence> </xs:complexType> </pre>					

element **cfFundDescr__Type/cfFundId**

diagram						
namespace	urn:xmlns:org:eurocris:cerif-1.6-2					
type	cfId__Type					
properties	isRef	0	content	simple		

facets	Kind maxLength	Value 128	annotation
source	<code><xs:element name="cfFundId" type="cfId__Type"/></code>		

element cfFundDescr__Type/cfDescr

diagram			
namespace	urn:xmlns:org:eurocris:cerif-1.6-2		
type	cfMLangString__Type		
properties	isRef	0	content complex
attributes	Name	Type	Use Default Fixed annotation
	cfLangCode	xs:string	required
	cfTrans	cfTrans__Type	required
source	<code><xs:element name="cfDescr" type="cfMLangString__Type"/></code>		

complexType cfFundKeyw__Type

diagram			
namespace	urn:xmlns:org:eurocris:cerif-1.6-2		
children	cfFundId cfKeyw		
used by	element	CERIF/cfFundKeyw	
source	<pre> <xs:complexType name="cfFundKeyw__Type"> <xs:sequence> <xs:element name="cfFundId" type="cfId__Type"/> <xs:element name="cfKeyw" type="cfMLangString__Type"/> </xs:sequence> </xs:complexType> </pre>		

element cfFundKeyw__Type/cfFundId

diagram			
namespace	urn:xmlns:org:eurocris:cerif-1.6-2		
type	cfId__Type		
properties	isRef	0	content simple
facets	Kind maxLength	Value 128	annotation
source	<code><xs:element name="cfFundId" type="cfId__Type"/></code>		

element **cfFundKeyw__Type**/cfKeyw

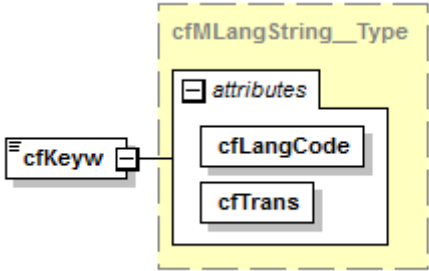
diagram																			
namespace	urn:xmlns:org:eurocris:cerif-1.6-2																		
type	cfMLangString__Type																		
properties	isRef 0 content complex																		
attributes	<table border="1"> <thead> <tr> <th>Name</th> <th>Type</th> <th>Use</th> <th>Default</th> <th>Fixed</th> <th>annotation</th> </tr> </thead> <tbody> <tr> <td>cfLangCode</td> <td>xs:string</td> <td>required</td> <td></td> <td></td> <td></td> </tr> <tr> <td>cfTrans</td> <td>cfTrans__Type</td> <td>required</td> <td></td> <td></td> <td></td> </tr> </tbody> </table>	Name	Type	Use	Default	Fixed	annotation	cfLangCode	xs:string	required				cfTrans	cfTrans__Type	required			
Name	Type	Use	Default	Fixed	annotation														
cfLangCode	xs:string	required																	
cfTrans	cfTrans__Type	required																	
source	<code><xs:element name="cfKeyw" type="cfMLangString__Type"/></code>																		

complexType **cfFundName__Type**

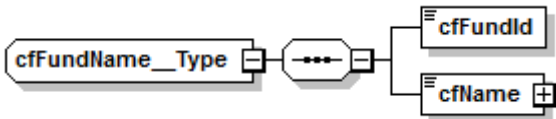
diagram	
namespace	urn:xmlns:org:eurocris:cerif-1.6-2
children	cfFundId cfName
used by	element CERIF/cfFundName
source	<code><xs:complexType name="cfFundName__Type"> <xs:sequence> <xs:element name="cfFundId" type="cfId__Type"/> <xs:element name="cfName" type="cfMLangString__Type"/> </xs:sequence> </xs:complexType></code>

element **cfFundName__Type**/cfFundId

diagram							
namespace	urn:xmlns:org:eurocris:cerif-1.6-2						
type	cfId__Type						
properties	isRef 0 content simple						
facets	<table border="1"> <thead> <tr> <th>Kind</th> <th>Value</th> <th>annotation</th> </tr> </thead> <tbody> <tr> <td>maxLength</td> <td>128</td> <td></td> </tr> </tbody> </table>	Kind	Value	annotation	maxLength	128	
Kind	Value	annotation					
maxLength	128						
source	<code><xs:element name="cfFundId" type="cfId__Type"/></code>						

element **cfFundName__Type/cfName**

diagram						
namespace	urn:xmlns:org:eurocris:cerif-1.6-2					
type	cfMLangString__Type					
properties	isRef	0	content	complex		
attributes	Name	Type	Use	Default	Fixed	annotation
	cfLangCode	xs:string	required			
	cfTrans	cfTrans__Type	required			
source	<code><xs:element name="cfName" type="cfMLangString__Type"/></code>					

complexType **cfIndic__Type**

diagram						
namespace	urn:xmlns:org:eurocris:cerif-1.6-2					
children	cfIndicId cfURI cfName cfDescr cfKeyw cfIndic_Meas cfIndic_Class cfPers_Indic cfOrgUnit_Indic cfProj_Indic cfResPubl_Indic cfEvent_Indic cfIndic_Indic cfFund_Indic cfFedId					
used by	element	CERIF/cfIndic				

source	<pre> <xs:complexType name="cfIndic__Type"> <xs:sequence> <xs:element name="cfIndicId" type="cfId__Type"/> <xs:element name="cfURI" type="xs:string" minOccurs="0"/> <xs:choice minOccurs="0" maxOccurs="unbounded"> <!-- embedded multiple-language attributes --> <xs:element name="cfName" type="cfMLangString__Type"/> <xs:element name="cfDescr" type="cfMLangString__Type"/> <xs:element name="cfKeyw" type="cfMLangString__Type"/> <!-- embedded linking entities --> <xs:element name="cfIndic_Meas"> <xs:complexType> <xs:sequence> <xs:element name="cfMeasId" type="cfId__Type"/> <xs:group ref="cfCoreClassWithFraction__Group"/> </xs:sequence> </xs:complexType> </xs:element> <xs:element name="cfIndic_Class" type="cfCoreClassWithFraction__Type"/> <xs:element name="cfPers_Indic"> <xs:complexType> <xs:sequence> <xs:element name="cfPersId" type="cfId__Type"/> <xs:group ref="cfCoreClassWithFraction__Group"/> </xs:sequence> </xs:complexType> </xs:element> <xs:element name="cfOrgUnit_Indic"> <xs:complexType> <xs:sequence> <xs:element name="cfOrgUnitId" type="cfId__Type"/> <xs:group ref="cfCoreClassWithFraction__Group"/> </xs:sequence> </xs:complexType> </xs:element> <xs:element name="cfProj_Indic"> <xs:complexType> <xs:sequence> <xs:element name="cfProjId" type="cfId__Type"/> <xs:group ref="cfCoreClassWithFraction__Group"/> </xs:sequence> </xs:complexType> </xs:element> <xs:element name="cfResPubl_Indic"> <xs:complexType> <xs:sequence> <xs:element name="cfResPublId" type="cfId__Type"/> <xs:group ref="cfCoreClassWithFraction__Group"/> </xs:sequence> </xs:complexType> </xs:element> <xs:element name="cfEvent_Indic"> <xs:complexType> <xs:sequence> <xs:element name="cfEventId" type="cfId__Type"/> <xs:group ref="cfCoreClassWithFraction__Group"/> </xs:sequence> </xs:complexType> </xs:element> <xs:element name="cfIndic_Indic"> <xs:complexType> <xs:sequence> </pre>
--------	--

```

<xs:choice>
  <xs:element name="cfIndicld2" type="cfd__Type"/>
  <xs:element name="cfIndicld1" type="cfd__Type"/>
</xs:choice>
<xs:group ref="cfCoreClassWithFraction__Group"/>
</xs:sequence>
</xs:complexType>
</xs:element>
<xs:element name="cfFund_Indic">
  <xs:complexType>
    <xs:sequence>
      <xs:element name="cfFundld" type="cfd__Type"/>
      <xs:group ref="cfCoreClassWithFraction__Group"/>
      <xs:element name="cfAmount" type="cfAmount__Type" minOccurs="0"/>
    </xs:sequence>
  </xs:complexType>
</xs:element>
<!-- embedded federated identifiers -->
<xs:element name="cfFedld" type="cfFedld__EmbType"/>
</xs:choice>
</xs:sequence>
</xs:complexType>
    
```

element **cfIndic__Type/cfIndicld**

diagram	
namespace	urn:xmlns:org:eurocris:cerif-1.6-2
type	cfd__Type
properties	isRef 0 content simple
facets	Kind Value annotation maxLength 128
source	<code><xs:element name="cfIndicld" type="cfd__Type"/></code>

element **cfIndic__Type/cfURI**

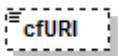
diagram	
namespace	urn:xmlns:org:eurocris:cerif-1.6-2
type	xs:string
properties	isRef 0 minOcc 0 maxOcc 1 content simple
source	<code><xs:element name="cfURI" type="xs:string" minOccurs="0"/></code>

element cfIndic__Type/cfName

diagram						
namespace	urn:xmlns:org:eurocris:cerif-1.6-2					
type	cfMLangString__Type					
properties	isRef	0	content	complex		
attributes	Name	Type	Use	Default	Fixed	annotation
	cfLangCode	xs:string	required			
	cfTrans	cfTrans__Type	required			
source	<code><xs:element name="cfName" type="cfMLangString__Type"/></code>					

element cfIndic__Type/cfDescr

diagram						
namespace	urn:xmlns:org:eurocris:cerif-1.6-2					
type	cfMLangString__Type					
properties	isRef	0	content	complex		
attributes	Name	Type	Use	Default	Fixed	annotation
	cfLangCode	xs:string	required			
	cfTrans	cfTrans__Type	required			
source	<code><xs:element name="cfDescr" type="cfMLangString__Type"/></code>					

element cfIndic__Type/cfKeyw

diagram						
namespace	urn:xmlns:org:eurocris:cerif-1.6-2					
type	cfMLangString__Type					
properties	isRef	0	content	complex		

attributes	Name	Type	Use	Default	Fixed	annotation
	cfLangCode	xs:string	required			
	cfTrans	cfTrans_Type	required			
source	<code><xs:element name="cfKeyw" type="cfMLangString__Type"/></code>					

element cfIndic_Type/cfIndic_Meas

diagram	
namespace	urn:xmlns:org:eurocris:cerif-1.6-2
properties	isRef 0 content complex
children	cfMeasId cfClassId cfClassSchemeld cfStartDate cfEndDate cfFraction
source	<pre> <xs:element name="cfIndic_Meas"> <xs:complexType> <xs:sequence> <xs:element name="cfMeasId" type="cfId__Type"/> <xs:group ref="cfCoreClassWithFraction__Group"/> </xs:sequence> </xs:complexType> </xs:element> </pre>

element cfIndic_Type/cfIndic_Meas/cfMeasId

diagram	
namespace	urn:xmlns:org:eurocris:cerif-1.6-2
type	cfId_Type
properties	isRef 0 content simple
facets	Kind Value annotation maxLength 128
source	<code><xs:element name="cfMeasId" type="cfId__Type"/></code>

element cfIndic_Type/cfIndic_Class

diagram	
namespace	urn:xmlns:org:eurocris:cerif-1.6-2
type	cfCoreClassWithFraction_Type
properties	isRef 0 content complex

children	cfClassId cfClassSchemeld cfStartDate cfEndDate cfFraction
source	<code><xs:element name="cfIndic_Class" type="cfCoreClassWithFraction__Type"/></code>

element cfIndic__Type/cfPers_Indic

diagram	
namespace	urn:xmlns:org:eurocris:cerif-1.6-2
properties	isRef 0 content complex
children	cfPersId cfClassId cfClassSchemeld cfStartDate cfEndDate cfFraction
source	<pre> <xs:element name="cfPers_Indic"> <xs:complexType> <xs:sequence> <xs:element name="cfPersId" type="cfId__Type"/> <xs:group ref="cfCoreClassWithFraction__Group"/> </xs:sequence> </xs:complexType> </xs:element> </pre>

element cfIndic__Type/cfPers_Indic/cfPersId

diagram	
namespace	urn:xmlns:org:eurocris:cerif-1.6-2
type	cfId__Type
properties	isRef 0 content simple
facets	Kind Value annotation maxLength 128
source	<code><xs:element name="cfPersId" type="cfId__Type"/></code>

element cfIndic__Type/cfOrgUnit_Indic

diagram	
namespace	urn:xmlns:org:eurocris:cerif-1.6-2
properties	isRef 0 content complex
children	cfOrgUnitId cfClassId cfClassSchemeld cfStartDate cfEndDate cfFraction
source	<pre> <xs:element name="cfOrgUnit_Indic"> <xs:complexType> </pre>

	<pre> <xs:sequence> <xs:element name="cfOrgUnitId" type="cfId__Type"/> <xs:group ref="cfCoreClassWithFraction__Group"/> </xs:sequence> </xs:complexType> </xs:element> </pre>
--	---

element cfIndic__Type/cfOrgUnit_Indic/cfOrgUnitId

diagram	
namespace	urn:xmlns:org:eurocris:cerif-1.6-2
type	cfId__Type
properties	isRef 0 content simple
facets	Kind Value annotation maxLength 128
source	<pre><xs:element name="cfOrgUnitId" type="cfId__Type"/></pre>

element cfIndic__Type/cfProj_Indic

diagram	
namespace	urn:xmlns:org:eurocris:cerif-1.6-2
properties	isRef 0 content complex
children	cfProjId cfClassId cfClassSchemeld cfStartDate cfEndDate cfFraction
source	<pre> <xs:element name="cfProj_Indic"> <xs:complexType> <xs:sequence> <xs:element name="cfProjId" type="cfId__Type"/> <xs:group ref="cfCoreClassWithFraction__Group"/> </xs:sequence> </xs:complexType> </xs:element> </pre>

element cfIndic__Type/cfProj_Indic/cfProjId

diagram	
namespace	urn:xmlns:org:eurocris:cerif-1.6-2
type	cfId__Type
properties	isRef 0 content simple
facets	Kind Value annotation maxLength 128
source	<pre><xs:element name="cfProjId" type="cfId__Type"/></pre>

element **cfIndic__Type/cfResPubl_Indic**

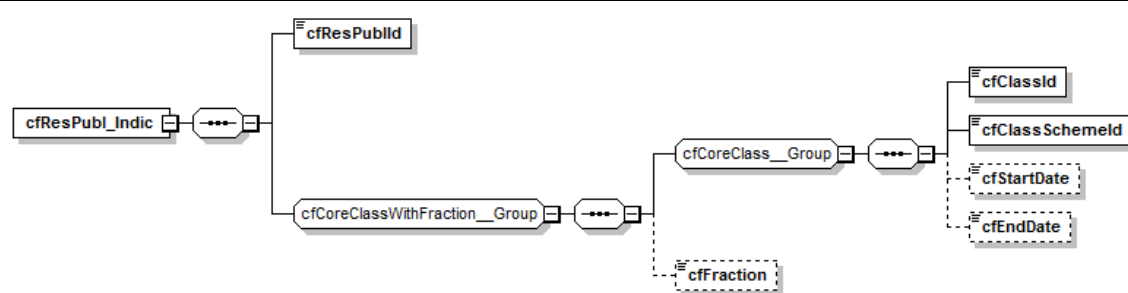
diagram	
namespace	urn:xmlns:org:eurocris:cerif-1.6-2
properties	isRef 0 content complex
children	cfResPublId cfClassId cfClassSchemeld cfStartDate cfEndDate cfFraction
source	<pre><xs:element name="cfResPubl_Indic"> <xs:complexType> <xs:sequence> <xs:element name="cfResPublId" type="cflD__Type"/> <xs:group ref="cfCoreClassWithFraction__Group"/> </xs:sequence> </xs:complexType> </xs:element></pre>

element **cfIndic__Type/cfResPubl_Indic/cfResPublId**

diagram	
namespace	urn:xmlns:org:eurocris:cerif-1.6-2
type	cflD__Type
properties	isRef 0 content simple
facets	Kind Value annotation maxLength 128
source	<pre><xs:element name="cfResPublId" type="cflD__Type"/></pre>

element **cfIndic__Type/cfEvent_Indic**

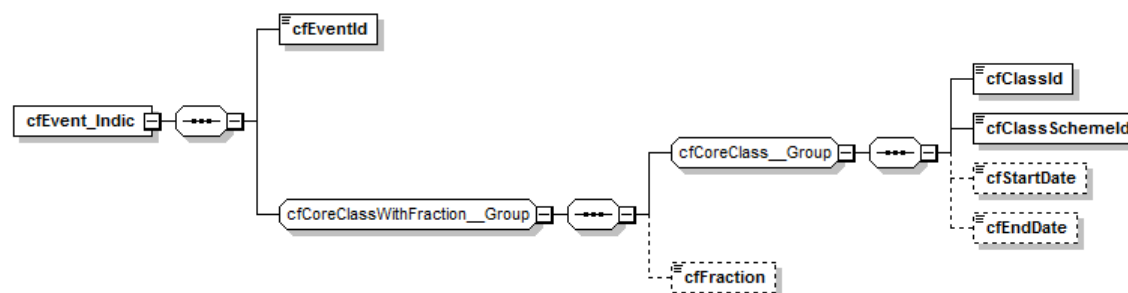
diagram	
namespace	urn:xmlns:org:eurocris:cerif-1.6-2
properties	isRef 0 content complex
children	cfEventId cfClassId cfClassSchemeld cfStartDate cfEndDate cfFraction
source	<pre><xs:element name="cfEvent_Indic"> <xs:complexType> <xs:sequence> <xs:element name="cfEventId" type="cflD__Type"/> <xs:group ref="cfCoreClassWithFraction__Group"/> </xs:sequence> </xs:complexType> </xs:element></pre>

	<pre></xs:complexType> </xs:element></pre>
--	--

element **cfIndic__Type/cfEvent__Indic/cfEventId**

diagram	
namespace	urn:xmlns:org:eurocris:cerif-1.6-2
type	cfd__Type
properties	isRef 0 content simple
facets	Kind Value annotation maxLength 128
source	<pre><xs:element name="cfEventId" type="cfd__Type"/></pre>

element **cfIndic__Type/cfIndic__Indic**

diagram	
namespace	urn:xmlns:org:eurocris:cerif-1.6-2
properties	isRef 0 content complex
children	cfIndicId2 cfIndicId1 cfClassId cfClassSchemeId cfStartDate cfEndDate cfFraction
source	<pre><xs:element name="cfIndic__Indic"> <xs:complexType> <xs:sequence> <xs:choice> <xs:element name="cfIndicId2" type="cfd__Type"/> <xs:element name="cfIndicId1" type="cfd__Type"/> </xs:choice> <xs:group ref="cfCoreClassWithFraction__Group"/> </xs:sequence> </xs:complexType> </xs:element></pre>

element **cfIndic__Type/cfIndic__Indic/cfIndicId2**

diagram	
namespace	urn:xmlns:org:eurocris:cerif-1.6-2
type	cfd__Type
properties	isRef 0 content simple
facets	Kind Value annotation maxLength 128
source	<pre><xs:element name="cfIndicId2" type="cfd__Type"/></pre>

element **cfIndic__Type/cfIndic_Indic/cfIndicId1**

diagram	
namespace	urn:xmlns:org:eurocris:cerif-1.6-2
type	cfdl__Type
properties	isRef 0 content simple
facets	Kind Value annotation maxLength 128
source	<code><xs:element name="cfIndicId1" type="cfdl__Type"/></code>

element **cfIndic__Type/cfFund_Indic**

diagram	
namespace	urn:xmlns:org:eurocris:cerif-1.6-2
properties	isRef 0 content complex
children	cfFundId cfClassId cfClassSchemeId cfStartDate cfEndDate cfFraction cfAmount
source	<code><xs:element name="cfFund_Indic"> <xs:complexType> <xs:sequence> <xs:element name="cfFundId" type="cfdl__Type"/> <xs:group ref="cfCoreClassWithFraction__Group"/> <xs:element name="cfAmount" type="cfAmount__Type" minOccurs="0"/> </xs:sequence> </xs:complexType> </xs:element></code>

element **cfIndic__Type/cfFund_Indic/cfFundId**

diagram	
namespace	urn:xmlns:org:eurocris:cerif-1.6-2
type	cfdl__Type
properties	isRef 0 content simple
facets	Kind Value annotation maxLength 128
source	<code><xs:element name="cfFundId" type="cfdl__Type"/></code>

element **cfIndic__Type/cfFund_Indic/cfAmount**

diagram						
namespace	urn:xmlns:org:eurocris:cerif-1.6-2					
type	cfAmount_Type					
properties	isRef	0	minOcc	0	maxOcc	1
	content	complex				
attributes	Name	Type	Use	Default	Fixed	annotation
	cfCurrCode	xs:string	required			
source	<code><xs:element name="cfAmount" type="cfAmount__Type" minOccurs="0"/></code>					

element **cfIndic__Type/cfFedId**

diagram						
namespace	urn:xmlns:org:eurocris:cerif-1.6-2					
type	cfFedId_EmbType					
properties	isRef	0	content	complex		
children	cfFedIdId cfFedId cfClassId cfClassSchemeld cfStartDate cfEndDate cfFedId_Class					
source	<code><xs:element name="cfFedId" type="cfFedId__EmbType"/></code>					

complexType **cfIndic_Class_Type**

diagram	
namespace	urn:xmlns:org:eurocris:cerif-1.6-2
children	cfIndicid cfClassid cfClassSchemeld cfStartDate cfEndDate cfFraction
used by	element CERIF/cfIndic_Class
source	<pre><xs:complexType name="cfIndic_Class_Type"> <xs:sequence> <xs:element name="cfIndicid" type="cfId_Type"/> <xs:group ref="cfCoreClassWithFraction_Group"/> </xs:sequence> </xs:complexType></pre>

element **cfIndic_Class_Type/cfIndicid**

diagram	
namespace	urn:xmlns:org:eurocris:cerif-1.6-2
type	cfId_Type
properties	isRef 0 content simple
facets	Kind Value annotation maxLength 128
source	<pre><xs:element name="cfIndicid" type="cfId_Type"/></pre>

complexType **cfIndic_Indic_Type**

diagram	
namespace	urn:xmlns:org:eurocris:cerif-1.6-2
children	cfIndicid1 cfIndicid2 cfClassid cfClassSchemeld cfStartDate cfEndDate cfFraction
used by	element CERIF/cfIndic_Indic
source	<pre><xs:complexType name="cfIndic_Indic_Type"> <xs:sequence> <xs:element name="cfIndicid1" type="cfId_Type"/> <xs:element name="cfIndicid2" type="cfId_Type"/> <xs:group ref="cfCoreClassWithFraction_Group"/> </xs:sequence> </xs:complexType></pre>

element **cfIndic_Indic_Type/cfIndicId1**

diagram	
namespace	urn:xmlns:org:eurocris:cerif-1.6-2
type	cfId_Type
properties	isRef 0 content simple
facets	Kind Value annotation maxLength 128
source	<code><xs:element name="cfIndicId1" type="cfId_Type"/></code>

element **cfIndic_Indic_Type/cfIndicId2**

diagram	
namespace	urn:xmlns:org:eurocris:cerif-1.6-2
type	cfId_Type
properties	isRef 0 content simple
facets	Kind Value annotation maxLength 128
source	<code><xs:element name="cfIndicId2" type="cfId_Type"/></code>

complexType **cfIndic_Meas_Type**

diagram	
namespace	urn:xmlns:org:eurocris:cerif-1.6-2
children	cfIndicId cfMeasId cfClassId cfClassSchemId cfStartDate cfEndDate cfFraction
used by	element CERIF/cfIndic_Meas
source	<code><xs:complexType name="cfIndic_Meas_Type"> <xs:sequence> <xs:element name="cfIndicId" type="cfId_Type"/> <xs:element name="cfMeasId" type="cfId_Type"/> <xs:group ref="cfCoreClassWithFraction_Group"/> </xs:sequence> </xs:complexType></code>

element **cfIndic_Meas_Type/cfIndicId**

diagram	
namespace	urn:xmlns:org:eurocris:cerif-1.6-2
type	cfId_Type

properties	isRef 0 content simple
facets	Kind Value annotation maxLength 128
source	<code><xs:element name="cfIndicId" type="cfd__Type"/></code>

element **cfIndic_Meas_Type/cfMeasId**

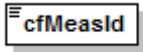
diagram	
namespace	urn:xmlns:org:eurocris:cerif-1.6-2
type	cfd__Type
properties	isRef 0 content simple
facets	Kind Value annotation maxLength 128
source	<code><xs:element name="cfMeasId" type="cfd__Type"/></code>

complexType **cfIndicDescr_Type**

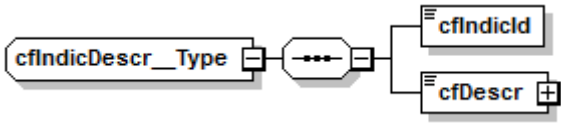
diagram	
namespace	urn:xmlns:org:eurocris:cerif-1.6-2
children	cfIndicId cfDescr
used by	element CERIF/cfIndicDescr
source	<code><xs:complexType name="cfIndicDescr_Type"> <xs:sequence> <xs:element name="cfIndicId" type="cfd__Type"/> <xs:element name="cfDescr" type="cfMLangString__Type"/> </xs:sequence> </xs:complexType></code>

element **cfIndicDescr_Type/cfIndicId**

diagram	
namespace	urn:xmlns:org:eurocris:cerif-1.6-2
type	cfd__Type
properties	isRef 0 content simple
facets	Kind Value annotation maxLength 128
source	<code><xs:element name="cfIndicId" type="cfd__Type"/></code>

element **cfIndicDescr__Type/cfDescr**

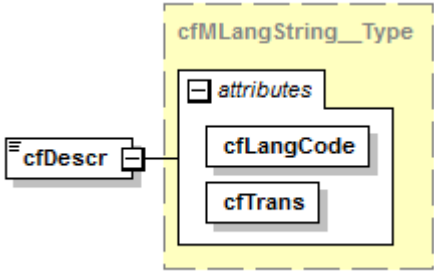
diagram																			
namespace	urn:xmlns:org:eurocris:cerif-1.6-2																		
type	cfMLangString__Type																		
properties	isRef 0 content complex																		
attributes	<table border="1"> <thead> <tr> <th>Name</th> <th>Type</th> <th>Use</th> <th>Default</th> <th>Fixed</th> <th>annotation</th> </tr> </thead> <tbody> <tr> <td>cfLangCode</td> <td>xs:string</td> <td>required</td> <td></td> <td></td> <td></td> </tr> <tr> <td>cfTrans</td> <td>cfTrans__Type</td> <td>required</td> <td></td> <td></td> <td></td> </tr> </tbody> </table>	Name	Type	Use	Default	Fixed	annotation	cfLangCode	xs:string	required				cfTrans	cfTrans__Type	required			
Name	Type	Use	Default	Fixed	annotation														
cfLangCode	xs:string	required																	
cfTrans	cfTrans__Type	required																	
source	<code><xs:element name="cfDescr" type="cfMLangString__Type"/></code>																		

complexType **cfIndicKeyw__Type**

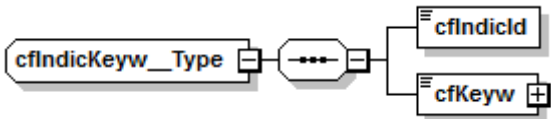
diagram	
namespace	urn:xmlns:org:eurocris:cerif-1.6-2
children	cfIndicId cfKeyw
used by	element CERIF/cfIndicKeyw
source	<code><xs:complexType name="cfIndicKeyw__Type"> <xs:sequence> <xs:element name="cfIndicId" type="cfId__Type"/> <xs:element name="cfKeyw" type="cfMLangString__Type"/> </xs:sequence> </xs:complexType></code>

element **cfIndicKeyw__Type/cfIndicId**

diagram							
namespace	urn:xmlns:org:eurocris:cerif-1.6-2						
type	cfId__Type						
properties	isRef 0 content simple						
facets	<table border="1"> <thead> <tr> <th>Kind</th> <th>Value</th> <th>annotation</th> </tr> </thead> <tbody> <tr> <td>maxLength</td> <td>128</td> <td></td> </tr> </tbody> </table>	Kind	Value	annotation	maxLength	128	
Kind	Value	annotation					
maxLength	128						
source	<code><xs:element name="cfIndicId" type="cfId__Type"/></code>						

element **cfIndicKeyw__Type/cfKeyw**

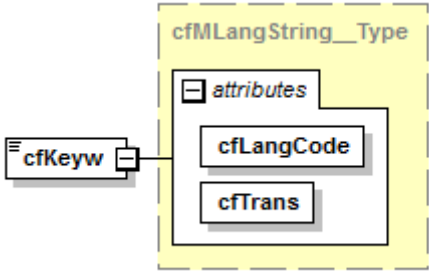
diagram																			
namespace	urn:xmlns:org:eurocris:cerif-1.6-2																		
type	cfMLangString__Type																		
properties	isRef 0 content complex																		
attributes	<table border="1"> <thead> <tr> <th>Name</th> <th>Type</th> <th>Use</th> <th>Default</th> <th>Fixed</th> <th>annotation</th> </tr> </thead> <tbody> <tr> <td>cfLangCode</td> <td>xs:string</td> <td>required</td> <td></td> <td></td> <td></td> </tr> <tr> <td>cfTrans</td> <td>cfTrans__Type</td> <td>required</td> <td></td> <td></td> <td></td> </tr> </tbody> </table>	Name	Type	Use	Default	Fixed	annotation	cfLangCode	xs:string	required				cfTrans	cfTrans__Type	required			
Name	Type	Use	Default	Fixed	annotation														
cfLangCode	xs:string	required																	
cfTrans	cfTrans__Type	required																	
source	<code><xs:element name="cfKeyw" type="cfMLangString__Type"/></code>																		

complexType **cfIndicName__Type**

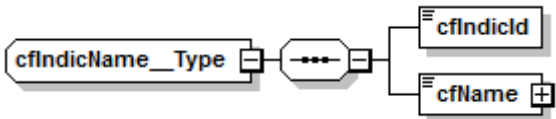
diagram	
namespace	urn:xmlns:org:eurocris:cerif-1.6-2
children	cfIndicId cfName
used by	element CERIF/cfIndicName
source	<code><xs:complexType name="cfIndicName__Type"> <xs:sequence> <xs:element name="cfIndicId" type="cfId__Type"/> <xs:element name="cfName" type="cfMLangString__Type"/> </xs:sequence> </xs:complexType></code>

element **cfIndicName__Type/cfIndicId**

diagram							
namespace	urn:xmlns:org:eurocris:cerif-1.6-2						
type	cfId__Type						
properties	isRef 0 content simple						
facets	<table border="1"> <thead> <tr> <th>Kind</th> <th>Value</th> <th>annotation</th> </tr> </thead> <tbody> <tr> <td>maxLength</td> <td>128</td> <td></td> </tr> </tbody> </table>	Kind	Value	annotation	maxLength	128	
Kind	Value	annotation					
maxLength	128						
source	<code><xs:element name="cfIndicId" type="cfId__Type"/></code>						

element **cfIndicName__Type/cfName**

diagram						
namespace	urn:xmlns:org:eurocris:cerif-1.6-2					
type	cfMLangString__Type					
properties	isRef	0	content	complex		
attributes	Name	Type	Use	Default	Fixed	annotation
	cfLangCode	xs:string	required			
	cfTrans	cfTrans__Type	required			
source	<code><xs:element name="cfName" type="cfMLangString__Type"/></code>					

complexType **cfLang__Type**

diagram						
namespace	urn:xmlns:org:eurocris:cerif-1.6-2					
children	cfLangCode cfURI cfName cfPers_Lang cfLang_Class cfFedId					
used by	element	CERIF/cfLang				
source	<pre> <xs:complexType name="cfLang__Type"> <xs:sequence> <xs:element name="cfLangCode" type="xs:string"/> <xs:element name="cfURI" type="xs:string" minOccurs="0"/> <xs:choice minOccurs="0" maxOccurs="unbounded"> <!-- embedded multiple-language attributes --> <xs:element name="cfName" type="cfMLangString__Type"/> <!-- embedded linking entities --> <xs:element name="cfPers_Lang"> <xs:complexType> <xs:sequence> <xs:element name="cfPersId" type="cfId__Type"/> <xs:group ref="cfCoreClassWithFraction__Group"/> <xs:element name="cfSkillReading" type="xs:string" minOccurs="0"/> <xs:element name="cfSkillSpeaking" type="xs:string" minOccurs="0"/> <xs:element name="cfSkillWriting" type="xs:string" minOccurs="0"/> </xs:sequence> </xs:complexType> </xs:element> <xs:element name="cfLang_Class" type="cfCoreClassWithFraction__Type"/> </xs:choice> </xs:sequence> </xs:complexType> </pre>					

	<pre> <!-- embedded federated identifiers --> <xs:element name="cfFedId" type="cfFedId__EmbType"/> </xs:choice> </xs:sequence> </xs:complexType> </pre>
--	---

element cfLang__Type/cfLangCode

diagram	
namespace	urn:xmlns:org:eurocris:cerif-1.6-2
type	xs:string
properties	isRef 0 content simple
source	<code><xs:element name="cfLangCode" type="xs:string"/></code>

element cfLang__Type/cfURI

diagram	
namespace	urn:xmlns:org:eurocris:cerif-1.6-2
type	xs:string
properties	isRef 0 minOcc 0 maxOcc 1 content simple
source	<code><xs:element name="cfURI" type="xs:string" minOccurs="0"/></code>

element cfLang__Type/cfName

diagram																			
namespace	urn:xmlns:org:eurocris:cerif-1.6-2																		
type	cfMLangString__Type																		
properties	isRef 0 content complex																		
attributes	<table border="1"> <thead> <tr> <th>Name</th> <th>Type</th> <th>Use</th> <th>Default</th> <th>Fixed</th> <th>annotation</th> </tr> </thead> <tbody> <tr> <td>cfLangCode</td> <td>xs:string</td> <td>required</td> <td></td> <td></td> <td></td> </tr> <tr> <td>cfTrans</td> <td>cfTrans__Type</td> <td>required</td> <td></td> <td></td> <td></td> </tr> </tbody> </table>	Name	Type	Use	Default	Fixed	annotation	cfLangCode	xs:string	required				cfTrans	cfTrans__Type	required			
Name	Type	Use	Default	Fixed	annotation														
cfLangCode	xs:string	required																	
cfTrans	cfTrans__Type	required																	
source	<code><xs:element name="cfName" type="cfMLangString__Type"/></code>																		

element **cfLang_Type/cfPers_Lang**

diagram	
namespace	urn:xmlns:org:eurocris:cerif-1.6-2
properties	isRef 0 content complex
children	cfPersId cfClassId cfClassSchemeld cfStartDate cfEndDate cfFraction cfSkillReading cfSkillSpeaking cfSkillWriting
source	<pre> <xs:element name="cfPers_Lang"> <xs:complexType> <xs:sequence> <xs:element name="cfPersId" type="cfId__Type"/> <xs:group ref="cfCoreClassWithFraction__Group"/> <xs:element name="cfSkillReading" type="xs:string" minOccurs="0"/> <xs:element name="cfSkillSpeaking" type="xs:string" minOccurs="0"/> <xs:element name="cfSkillWriting" type="xs:string" minOccurs="0"/> </xs:sequence> </xs:complexType> </xs:element> </pre>

element **cfLang_Type/cfPers_Lang/cfPersId**

diagram	
namespace	urn:xmlns:org:eurocris:cerif-1.6-2
type	cfId_Type
properties	isRef 0 content simple
facets	Kind Value annotation maxLength 128
source	<pre><xs:element name="cfPersId" type="cfId__Type"/></pre>

element **cfLang_Type/cfPers_Lang/cfSkillReading**

diagram	
namespace	urn:xmlns:org:eurocris:cerif-1.6-2
type	xs:string
properties	isRef 0 minOcc 0 maxOcc 1 content simple
source	<pre><xs:element name="cfSkillReading" type="xs:string" minOccurs="0"/></pre>

element cfLang__Type/cfPers_Lang/cfSkillSpeaking

diagram	
namespace	urn:xmlns:org:eurocris:cerif-1.6-2
type	xs:string
properties	isRef 0 minOcc 0 maxOcc 1 content simple
source	<xs:element name="cfSkillSpeaking" type="xs:string" minOccurs="0"/>

element cfLang__Type/cfPers_Lang/cfSkillWriting

diagram	
namespace	urn:xmlns:org:eurocris:cerif-1.6-2
type	xs:string
properties	isRef 0 minOcc 0 maxOcc 1 content simple
source	<xs:element name="cfSkillWriting" type="xs:string" minOccurs="0"/>

element cfLang__Type/cfLang_Class

diagram	
namespace	urn:xmlns:org:eurocris:cerif-1.6-2
type	cfCoreClassWithFraction__Type
properties	isRef 0 content complex
children	cfClassId cfClassSchemeld cfStartDate cfEndDate cfFraction
source	<xs:element name="cfLang_Class" type="cfCoreClassWithFraction__Type"/>

element **cfLang_Type/cfFedId**

diagram	
namespace	urn:xmlns:org:eurocris:cerif-1.6-2
type	cfFedId__EmbType
properties	isRef 0 content complex
children	cfFedIdId cfFedId cfClassId cfClassSchemeld cfStartDate cfEndDate cfFedId_Class
source	<code><xs:element name="cfFedId" type="cfFedId__EmbType"/></code>

complexType **cfLang_Class_Type**

diagram	
namespace	urn:xmlns:org:eurocris:cerif-1.6-2
children	cfLangCode cfClassId cfClassSchemeld cfStartDate cfEndDate cfFraction
used by	element CERIF/cfLang_Class
source	<pre> <xs:complexType name="cfLang_Class_Type"> <xs:sequence> <xs:element name="cfLangCode" type="xs:string"/> <xs:group ref="cfCoreClassWithFraction__Group"/> </xs:sequence> </xs:complexType> </pre>

element **cfLang_Class_Type/cfLangCode**

diagram	
namespace	urn:xmlns:org:eurocris:cerif-1.6-2
type	xs:string
properties	isRef 0 content simple

source	<xs:element name="cfLangCode" type="xs:string"/>
--------	--

complexType cfLangName__Type

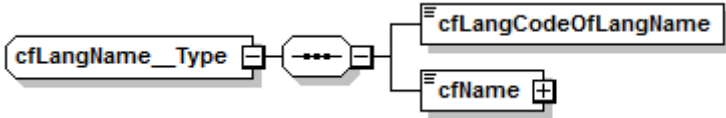
diagram	
namespace	urn:xmlns:org:eurocris:cerif-1.6-2
children	cfLangCodeOfLangName cfName
used by	element CERIF/cfLangName
source	<pre><xs:complexType name="cfLangName__Type"> <xs:sequence> <xs:element name="cfLangCodeOfLangName" type="xs:string"/> <xs:element name="cfName" type="cfMLangString__Type"/> </xs:sequence> </xs:complexType></pre>

element cfLangName__Type/cfLangCodeOfLangName

diagram	
namespace	urn:xmlns:org:eurocris:cerif-1.6-2
type	xs:string
properties	isRef 0 content simple
source	<xs:element name="cfLangCodeOfLangName" type="xs:string"/>

element cfLangName__Type/cfName

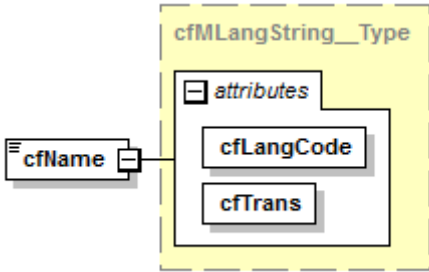
diagram																			
namespace	urn:xmlns:org:eurocris:cerif-1.6-2																		
type	cfMLangString__Type																		
properties	isRef 0 content complex																		
attributes	<table border="1"> <thead> <tr> <th>Name</th> <th>Type</th> <th>Use</th> <th>Default</th> <th>Fixed</th> <th>annotation</th> </tr> </thead> <tbody> <tr> <td>cfLangCode</td> <td>xs:string</td> <td>required</td> <td></td> <td></td> <td></td> </tr> <tr> <td>cfTrans</td> <td>cfTrans__Type</td> <td>required</td> <td></td> <td></td> <td></td> </tr> </tbody> </table>	Name	Type	Use	Default	Fixed	annotation	cfLangCode	xs:string	required				cfTrans	cfTrans__Type	required			
Name	Type	Use	Default	Fixed	annotation														
cfLangCode	xs:string	required																	
cfTrans	cfTrans__Type	required																	
source	<xs:element name="cfName" type="cfMLangString__Type"/>																		

complexType cfMeas__Type

<p>diagram</p>	
<p>namespace</p>	<p>urn:xmlns:org:eurocris:cerif-1.6-2</p>
<p>children</p>	<p>cfMeasId cfCountInt cfValFloatP cfValJudgeNum cfCountIntChange cfCountFloatPChange cfValJudgeNumChange cfValJudgeText cfValJudgeTextChange cfDateTime cfURI cfName cfDescr cfKeyw cfIndic_Meas cfMeas_Class cfPers_Meas cfOrgUnit_Meas cfProj_Meas cfResPubl_Meas cfEvent_Meas cfMeas_Meas cfFund_Meas cfFedId</p>
<p>used by</p>	<p>element CERIF/cfMeas</p>
<p>source</p>	<p><xs:complexType name="cfMeas__Type"></p>

```

<xs:sequence>
  <xs:element name="cfMeasId" type="cfId__Type"/>
  <xs:element name="cfCountInt" type="xs:int" minOccurs="0"/>
  <xs:element name="cfValFloatP" type="xs:float" minOccurs="0"/>
  <xs:element name="cfValJudgeNum" type="xs:float" minOccurs="0"/>
  <xs:element name="cfCountIntChange" type="xs:int" minOccurs="0"/>
  <xs:element name="cfCountFloatPChange" type="xs:float" minOccurs="0"/>
  <xs:element name="cfValJudgeNumChange" type="xs:float" minOccurs="0"/>
  <xs:element name="cfValJudgeText" type="xs:string" minOccurs="0"/>
  <xs:element name="cfValJudgeTextChange" type="xs:string" minOccurs="0"/>
  <xs:element name="cfDateTime" type="xs:dateTime" minOccurs="0"/>
  <xs:element name="cfURI" type="xs:string" minOccurs="0"/>
  <xs:choice minOccurs="0" maxOccurs="unbounded">
    <!-- embedded multiple-language attributes -->
    <xs:element name="cfName" type="cfMLangString__Type"/>
    <xs:element name="cfDescr" type="cfMLangString__Type"/>
    <xs:element name="cfKeyw" type="cfMLangString__Type"/>
    <!-- embedded linking entities -->
    <xs:element name="cfIndic_Meas">
      <xs:complexType>
        <xs:sequence>
          <xs:element name="cfIndicId" type="cfId__Type"/>
          <xs:group ref="cfCoreClassWithFraction__Group"/>
        </xs:sequence>
      </xs:complexType>
    </xs:element>
    <xs:element name="cfMeas_Class" type="cfCoreClassWithFraction__Type"/>
    <xs:element name="cfPers_Meas">
      <xs:complexType>
        <xs:sequence>
          <xs:element name="cfPersId" type="cfId__Type"/>
          <xs:group ref="cfCoreClassWithFraction__Group"/>
        </xs:sequence>
      </xs:complexType>
    </xs:element>
    <xs:element name="cfOrgUnit_Meas">
      <xs:complexType>
        <xs:sequence>
          <xs:element name="cfOrgUnitId" type="cfId__Type"/>
          <xs:group ref="cfCoreClassWithFraction__Group"/>
        </xs:sequence>
      </xs:complexType>
    </xs:element>
    <xs:element name="cfProj_Meas">
      <xs:complexType>
        <xs:sequence>
          <xs:element name="cfProjId" type="cfId__Type"/>
          <xs:group ref="cfCoreClassWithFraction__Group"/>
        </xs:sequence>
      </xs:complexType>
    </xs:element>
    <xs:element name="cfResPubl_Meas">
      <xs:complexType>
        <xs:sequence>
          <xs:element name="cfResPublId" type="cfId__Type"/>
          <xs:group ref="cfCoreClassWithFraction__Group"/>
        </xs:sequence>
      </xs:complexType>
    </xs:element>
    <xs:element name="cfEvent_Meas">
      <xs:complexType>
        <xs:sequence>

```

	<pre> <xs:element name="cfEventId" type="cfId__Type"/> <xs:group ref="cfCoreClassWithFraction__Group"/> </xs:sequence> </xs:complexType> </xs:element> <xs:element name="cfMeas_Meas"> <xs:complexType> <xs:sequence> <xs:choice> <xs:element name="cfMeasId2" type="cfId__Type"/> <xs:element name="cfMeasd1" type="cfId__Type"/> </xs:choice> <xs:group ref="cfCoreClassWithFraction__Group"/> </xs:sequence> </xs:complexType> </xs:element> <xs:element name="cfFund_Meas"> <xs:complexType> <xs:sequence> <xs:element name="cfFundId" type="cfId__Type"/> <xs:group ref="cfCoreClassWithFraction__Group"/> <xs:element name="cfAmount" type="cfAmount__Type" minOccurs="0"/> </xs:sequence> </xs:complexType> </xs:element> <!-- embedded federated identifiers --> <xs:element name="cfFedId" type="cfFedId__EmbType"/> </xs:choice> </xs:sequence> </xs:complexType> </pre>
--	--

element cfMeas__Type/cfMeasId

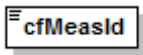
diagram	
namespace	urn:xmlns:org:eurocris:cerif-1.6-2
type	cfId__Type
properties	isRef 0 content simple
facets	Kind Value annotation maxLength 128
source	<code><xs:element name="cfMeasId" type="cfId__Type"/></code>

element cfMeas__Type/cfCountInt

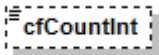
diagram	
namespace	urn:xmlns:org:eurocris:cerif-1.6-2
type	xs:int
properties	isRef 0 minOcc 0 maxOcc 1 content simple
source	<code><xs:element name="cfCountInt" type="xs:int" minOccurs="0"/></code>

element **cfMeas__Type/cfValFloatP**

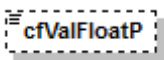
diagram	
namespace	urn:xmlns:org:eurocris:cerif-1.6-2
type	xs:float
properties	isRef 0 minOcc 0 maxOcc 1 content simple
source	<code><xs:element name="cfValFloatP" type="xs:float" minOccurs="0"/></code>

element **cfMeas__Type/cfValJudgeNum**

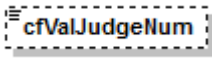
diagram	
namespace	urn:xmlns:org:eurocris:cerif-1.6-2
type	xs:float
properties	isRef 0 minOcc 0 maxOcc 1 content simple
source	<code><xs:element name="cfValJudgeNum" type="xs:float" minOccurs="0"/></code>

element **cfMeas__Type/cfCountIntChange**

diagram	
namespace	urn:xmlns:org:eurocris:cerif-1.6-2
type	xs:int
properties	isRef 0 minOcc 0 maxOcc 1 content simple
source	<code><xs:element name="cfCountIntChange" type="xs:int" minOccurs="0"/></code>

element **cfMeas__Type/cfCountFloatPChange**

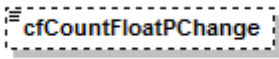
diagram	
namespace	urn:xmlns:org:eurocris:cerif-1.6-2
type	xs:float
properties	isRef 0 minOcc 0 maxOcc 1 content simple
source	<code><xs:element name="cfCountFloatPChange" type="xs:float" minOccurs="0"/></code>

element **cfMeas__Type/cfValJudgeNumChange**

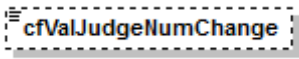
diagram	
namespace	urn:xmlns:org:eurocris:cerif-1.6-2
type	xs:float
properties	isRef 0 minOcc 0 maxOcc 1

	content simple
source	<code><xs:element name="cfValJudgeNumChange" type="xs:float" minOccurs="0"/></code>

element **cfMeas_Type/cfValJudgeText**

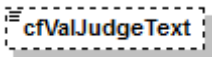
diagram	
namespace	urn:xmlns:org:eurocris:cerif-1.6-2
type	xs:string
properties	isRef 0 minOcc 0 maxOcc 1 content simple
source	<code><xs:element name="cfValJudgeText" type="xs:string" minOccurs="0"/></code>

element **cfMeas_Type/cfValJudgeTextChange**

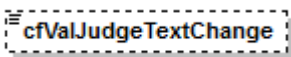
diagram	
namespace	urn:xmlns:org:eurocris:cerif-1.6-2
type	xs:string
properties	isRef 0 minOcc 0 maxOcc 1 content simple
source	<code><xs:element name="cfValJudgeTextChange" type="xs:string" minOccurs="0"/></code>

element **cfMeas_Type/cfDateTime**

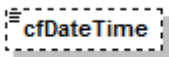
diagram	
namespace	urn:xmlns:org:eurocris:cerif-1.6-2
type	xs:dateTime
properties	isRef 0 minOcc 0 maxOcc 1 content simple
source	<code><xs:element name="cfDateTime" type="xs:dateTime" minOccurs="0"/></code>

element **cfMeas_Type/cfURI**

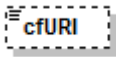
diagram	
namespace	urn:xmlns:org:eurocris:cerif-1.6-2
type	xs:string
properties	isRef 0 minOcc 0 maxOcc 1 content simple
source	<code><xs:element name="cfURI" type="xs:string" minOccurs="0"/></code>

element **cfMeas__Type/cfName**

diagram						
namespace	urn:xmlns:org:eurocris:cerif-1.6-2					
type	cfMLangString__Type					
properties	isRef	0	content	complex		
attributes	Name	Type	Use	Default	Fixed	annotation
	cfLangCode	xs:string	required			
	cfTrans	cfTrans__Type	required			
source	<code><xs:element name="cfName" type="cfMLangString__Type"/></code>					

element **cfMeas__Type/cfDescr**

diagram						
namespace	urn:xmlns:org:eurocris:cerif-1.6-2					
type	cfMLangString__Type					
properties	isRef	0	content	complex		
attributes	Name	Type	Use	Default	Fixed	annotation
	cfLangCode	xs:string	required			
	cfTrans	cfTrans__Type	required			
source	<code><xs:element name="cfDescr" type="cfMLangString__Type"/></code>					

element **cfMeas__Type/cfKeyw**

diagram						
namespace	urn:xmlns:org:eurocris:cerif-1.6-2					
type	cfMLangString__Type					
properties	isRef	0	content	complex		

attributes	Name	Type	Use	Default	Fixed	annotation
	cfLangCode	xs:string	required			
	cfTrans	cfTrans_Type	required			
source	<code><xs:element name="cfKeyw" type="cfMLangString__Type"/></code>					

element cfMeas_Type/cfIndic_Meas

diagram	
namespace	urn:xmlns:org:eurocris:cerif-1.6-2
properties	isRef 0 content complex
children	cfIndicId cfClassId cfClassSchemeld cfStartDate cfEndDate cfFraction
source	<pre> <xs:element name="cfIndic_Meas"> <xs:complexType> <xs:sequence> <xs:element name="cfIndicId" type="cfId__Type"/> <xs:group ref="cfCoreClassWithFraction__Group"/> </xs:sequence> </xs:complexType> </xs:element> </pre>

element cfMeas_Type/cfIndic_Meas/cfIndicId

diagram	
namespace	urn:xmlns:org:eurocris:cerif-1.6-2
type	cfId_Type
properties	isRef 0 content simple
facets	Kind Value annotation maxLength 128
source	<code><xs:element name="cfIndicId" type="cfId__Type"/></code>

element cfMeas_Type/cfMeas_Class

diagram	
namespace	urn:xmlns:org:eurocris:cerif-1.6-2
type	cfCoreClassWithFraction_Type

properties	isRef 0 content complex
children	cfClassId cfClassSchemeld cfStartDate cfEndDate cfFraction
source	<code><xs:element name="cfMeas_Class" type="cfCoreClassWithFraction__Type"/></code>

element **cfMeas__Type/cfPers_Meas**

diagram	
namespace	urn:xmlns:org:eurocris:cerif-1.6-2
properties	isRef 0 content complex
children	cfPersId cfClassId cfClassSchemeld cfStartDate cfEndDate cfFraction
source	<code><xs:element name="cfPers_Meas"> <xs:complexType> <xs:sequence> <xs:element name="cfPersId" type="cfId__Type"/> <xs:group ref="cfCoreClassWithFraction__Group"/> </xs:sequence> </xs:complexType> </xs:element></code>

element **cfMeas__Type/cfPers_Meas/cfPersId**

diagram	
namespace	urn:xmlns:org:eurocris:cerif-1.6-2
type	cfId__Type
properties	isRef 0 content simple
facets	Kind Value annotation maxLength 128
source	<code><xs:element name="cfPersId" type="cfId__Type"/></code>

element **cfMeas__Type/cfOrgUnit_Meas**

diagram	
namespace	urn:xmlns:org:eurocris:cerif-1.6-2
properties	isRef 0 content complex

children	cfOrgUnitId cfClassId cfClassSchemeld cfStartDate cfEndDate cfFraction
source	<pre><xs:element name="cfOrgUnit_Meas"> <xs:complexType> <xs:sequence> <xs:element name="cfOrgUnitId" type="cfId__Type"/> <xs:group ref="cfCoreClassWithFraction__Group"/> </xs:sequence> </xs:complexType> </xs:element></pre>

element cfMeas__Type/cfOrgUnit_Meas/cfOrgUnitId

diagram	
namespace	urn:xmlns:org:eurocris:cerif-1.6-2
type	cfId__Type
properties	isRef 0 content simple
facets	Kind Value annotation maxLength 128
source	<pre><xs:element name="cfOrgUnitId" type="cfId__Type"/></pre>

element cfMeas__Type/cfProj_Meas

diagram	
namespace	urn:xmlns:org:eurocris:cerif-1.6-2
properties	isRef 0 content complex
children	cfProjId cfClassId cfClassSchemeld cfStartDate cfEndDate cfFraction
source	<pre><xs:element name="cfProj_Meas"> <xs:complexType> <xs:sequence> <xs:element name="cfProjId" type="cfId__Type"/> <xs:group ref="cfCoreClassWithFraction__Group"/> </xs:sequence> </xs:complexType> </xs:element></pre>

element cfMeas__Type/cfProj_Meas/cfProjId

diagram	
namespace	urn:xmlns:org:eurocris:cerif-1.6-2
type	cfId__Type
properties	isRef 0 content simple
facets	Kind Value annotation maxLength 128

source	<code><xs:element name="cfProjId" type="cflD__Type"/></code>
--------	--

element **cfMeas__Type/cfResPubl_Meas**

diagram	
namespace	urn:xmlns:org:eurocris:cerif-1.6-2
properties	isRef 0 content complex
children	cfResPublId cfClassId cfClassSchemeId cfStartDate cfEndDate cfFraction
source	<pre><xs:element name="cfResPubl_Meas"> <xs:complexType> <xs:sequence> <xs:element name="cfResPublId" type="cflD__Type"/> <xs:group ref="cfCoreClassWithFraction__Group"/> </xs:sequence> </xs:complexType> </xs:element></pre>

element **cfMeas__Type/cfResPubl_Meas/cfResPublId**

diagram	
namespace	urn:xmlns:org:eurocris:cerif-1.6-2
type	cflD__Type
properties	isRef 0 content simple
facets	Kind Value annotation maxLength 128
source	<code><xs:element name="cfResPublId" type="cflD__Type"/></code>

element **cfMeas__Type/cfEvent_Meas**

diagram	
namespace	urn:xmlns:org:eurocris:cerif-1.6-2
properties	isRef 0 content complex
children	cfEventId cfClassId cfClassSchemeId cfStartDate cfEndDate cfFraction
source	<pre><xs:element name="cfEvent_Meas"> <xs:complexType> <xs:sequence> <xs:element name="cfEventId" type="cflD__Type"/> </xs:sequence> </xs:complexType> </xs:element></pre>

	<pre><xs:group ref="cfCoreClassWithFraction__Group"/> </xs:sequence> </xs:complexType> </xs:element></pre>
--	--

element **cfMeas__Type/cfEvent_Meas/cfEventId**

diagram	
namespace	urn:xmlns:org:eurocris:cerif-1.6-2
type	cfId__Type
properties	isRef 0 content simple
facets	Kind Value annotation maxLength 128
source	<pre><xs:element name="cfEventId" type="cfId__Type"/></pre>

element **cfMeas__Type/cfMeas_Meas**

diagram	
namespace	urn:xmlns:org:eurocris:cerif-1.6-2
properties	isRef 0 content complex
children	cfMeasId2 cfMeasId1 cfClassId cfClassSchemeld cfStartDate cfEndDate cfFraction
source	<pre><xs:element name="cfMeas_Meas"> <xs:complexType> <xs:sequence> <xs:choice> <xs:element name="cfMeasId2" type="cfId__Type"/> <xs:element name="cfMeasId1" type="cfId__Type"/> </xs:choice> <xs:group ref="cfCoreClassWithFraction__Group"/> </xs:sequence> </xs:complexType> </xs:element></pre>

element **cfMeas__Type/cfMeas_Meas/cfMeasId2**

diagram	
namespace	urn:xmlns:org:eurocris:cerif-1.6-2
type	cfId__Type
properties	isRef 0 content simple
facets	Kind Value annotation maxLength 128
source	<pre><xs:element name="cfMeasId2" type="cfId__Type"/></pre>

element **cfMeas_Type/cfMeas_Meas/cfMeasd1**

diagram	
namespace	urn:xmlns:org:eurocris:cerif-1.6-2
type	cflid_Type
properties	isRef 0 content simple
facets	Kind Value annotation maxLength 128
source	<code><xs:element name="cfMeasd1" type="cflid_Type"/></code>

element **cfMeas_Type/cfFund_Meas**

diagram	
namespace	urn:xmlns:org:eurocris:cerif-1.6-2
properties	isRef 0 content complex
children	cfFundId cfClassId cfClassSchemeld cfStartDate cfEndDate cfFraction cfAmount
source	<code><xs:element name="cfFund_Meas"> <xs:complexType> <xs:sequence> <xs:element name="cfFundId" type="cflid_Type"/> <xs:group ref="cfCoreClassWithFraction_Group"/> <xs:element name="cfAmount" type="cfAmount_Type" minOccurs="0"/> </xs:sequence> </xs:complexType> </xs:element></code>

element **cfMeas_Type/cfFund_Meas/cfFundId**

diagram	
namespace	urn:xmlns:org:eurocris:cerif-1.6-2
type	cflid_Type
properties	isRef 0 content simple
facets	Kind Value annotation maxLength 128
source	<code><xs:element name="cfFundId" type="cflid_Type"/></code>

element **cfMeas__Type/cfFund_Meas/cfAmount**

diagram						
namespace	urn:xmlns:org:eurocris:cerif-1.6-2					
type	cfAmount_Type					
properties	isRef	0	minOcc	0	maxOcc	1
	content	complex				
attributes	Name	Type	Use	Default	Fixed	annotation
	cfCurrCode	xs:string	required			
source	<code><xs:element name="cfAmount" type="cfAmount_Type" minOccurs="0"/></code>					

element **cfMeas__Type/cfFedId**

diagram						
namespace	urn:xmlns:org:eurocris:cerif-1.6-2					
type	cfFedId_EmbType					
properties	isRef	0	content	complex		
children	cfFedIdId cfFedId cfClassId cfClassSchemeld cfStartDate cfEndDate cfFedId_Class					
source	<code><xs:element name="cfFedId" type="cfFedId__EmbType"/></code>					

complexType **cfMeas_Class_Type**

diagram	
namespace	urn.xmlns:org:eurocris:cerif-1.6-2
children	cfMeasId cfClassId cfClassSchemeld cfStartDate cfEndDate cfFraction
used by	element CERIF/cfMeas_Class
source	<pre><xs:complexType name="cfMeas_Class_Type"> <xs:sequence> <xs:element name="cfMeasId" type="cfId__Type"/> <xs:group ref="cfCoreClassWithFraction_Group"/> </xs:sequence> </xs:complexType></pre>

element **cfMeas_Class_Type/cfMeasId**

diagram	
namespace	urn.xmlns:org:eurocris:cerif-1.6-2
type	cfId__Type
properties	isRef 0 content simple
facets	Kind Value annotation maxLength 128
source	<pre><xs:element name="cfMeasId" type="cfId__Type"/></pre>

complexType **cfMeas_Meas_Type**

diagram	
namespace	urn.xmlns:org:eurocris:cerif-1.6-2
children	cfMeasId1 cfMeasId2 cfClassId cfClassSchemeld cfStartDate cfEndDate cfFraction
used by	element CERIF/cfMeas_Meas
source	<pre><xs:complexType name="cfMeas_Meas_Type"> <xs:sequence> <xs:element name="cfMeasId1" type="cfId__Type"/> <xs:element name="cfMeasId2" type="cfId__Type"/> <xs:group ref="cfCoreClassWithFraction_Group"/> </xs:sequence> </xs:complexType></pre>

element **cfMeas_Meas_Type/cfMeasd1**

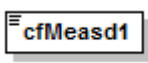
diagram	
namespace	urn:xmlns:org:eurocris:cerif-1.6-2
type	cflD_Type
properties	isRef 0 content simple
facets	Kind Value annotation maxLength 128
source	<code><xs:element name="cfMeasd1" type="cflD_Type"/></code>

element **cfMeas_Meas_Type/cfMeasId2**

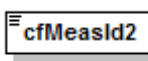
diagram	
namespace	urn:xmlns:org:eurocris:cerif-1.6-2
type	cflD_Type
properties	isRef 0 content simple
facets	Kind Value annotation maxLength 128
source	<code><xs:element name="cfMeasId2" type="cflD_Type"/></code>

complexType **cfMeasDescr__Type**

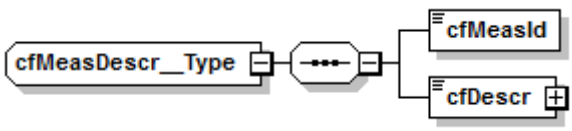
diagram	
namespace	urn:xmlns:org:eurocris:cerif-1.6-2
children	cfMeasId cfDescr
used by	element CERIF/cfMeasDescr
source	<code><xs:complexType name="cfMeasDescr__Type"> <xs:sequence> <xs:element name="cfMeasId" type="cflD_Type"/> <xs:element name="cfDescr" type="cfMLangString__Type"/> </xs:sequence> </xs:complexType></code>

element **cfMeasDescr__Type/cfMeasId**

diagram	
namespace	urn:xmlns:org:eurocris:cerif-1.6-2
type	cflD_Type
properties	isRef 0 content simple
facets	Kind Value annotation maxLength 128
source	<code><xs:element name="cfMeasId" type="cflD_Type"/></code>

element **cfMeasDescr__Type**/cfDescr

diagram																			
namespace	urn:xmlns:org:eurocris:cerif-1.6-2																		
type	cfMLangString__Type																		
properties	isRef 0 content complex																		
attributes	<table border="1"> <thead> <tr> <th>Name</th> <th>Type</th> <th>Use</th> <th>Default</th> <th>Fixed</th> <th>annotation</th> </tr> </thead> <tbody> <tr> <td>cfLangCode</td> <td>xs:string</td> <td>required</td> <td></td> <td></td> <td></td> </tr> <tr> <td>cfTrans</td> <td>cfTrans__Type</td> <td>required</td> <td></td> <td></td> <td></td> </tr> </tbody> </table>	Name	Type	Use	Default	Fixed	annotation	cfLangCode	xs:string	required				cfTrans	cfTrans__Type	required			
Name	Type	Use	Default	Fixed	annotation														
cfLangCode	xs:string	required																	
cfTrans	cfTrans__Type	required																	
source	<code><xs:element name="cfDescr" type="cfMLangString__Type"/></code>																		

complexType **cfMeasKeyw__Type**

diagram	
namespace	urn:xmlns:org:eurocris:cerif-1.6-2
children	cfMeasId cfKeyw
used by	element CERIF/cfMeasKeyw
source	<pre> <xs:complexType name="cfMeasKeyw__Type"> <xs:sequence> <xs:element name="cfMeasId" type="cfId__Type"/> <xs:element name="cfKeyw" type="cfMLangString__Type"/> </xs:sequence> </xs:complexType> </pre>

element **cfMeasKeyw__Type**/cfMeasId

diagram							
namespace	urn:xmlns:org:eurocris:cerif-1.6-2						
type	cfId__Type						
properties	isRef 0 content simple						
facets	<table border="1"> <thead> <tr> <th>Kind</th> <th>Value</th> <th>annotation</th> </tr> </thead> <tbody> <tr> <td>maxLength</td> <td>128</td> <td></td> </tr> </tbody> </table>	Kind	Value	annotation	maxLength	128	
Kind	Value	annotation					
maxLength	128						
source	<code><xs:element name="cfMeasId" type="cfId__Type"/></code>						

element **cfMeasKeyw__Type/cfKeyw**

diagram																			
namespace	urn:xmlns:org:eurocris:cerif-1.6-2																		
type	cfMLangString__Type																		
properties	isRef 0 content complex																		
attributes	<table border="1"> <thead> <tr> <th>Name</th> <th>Type</th> <th>Use</th> <th>Default</th> <th>Fixed</th> <th>annotation</th> </tr> </thead> <tbody> <tr> <td>cfLangCode</td> <td>xs:string</td> <td>required</td> <td></td> <td></td> <td></td> </tr> <tr> <td>cfTrans</td> <td>cfTrans__Type</td> <td>required</td> <td></td> <td></td> <td></td> </tr> </tbody> </table>	Name	Type	Use	Default	Fixed	annotation	cfLangCode	xs:string	required				cfTrans	cfTrans__Type	required			
Name	Type	Use	Default	Fixed	annotation														
cfLangCode	xs:string	required																	
cfTrans	cfTrans__Type	required																	
source	<code><xs:element name="cfKeyw" type="cfMLangString__Type"/></code>																		

complexType **cfMeasName__Type**

diagram	
namespace	urn:xmlns:org:eurocris:cerif-1.6-2
children	cfMeasId cfName
used by	element CERIF/cfMeasName
source	<pre> <xs:complexType name="cfMeasName__Type"> <xs:sequence> <xs:element name="cfMeasId" type="cfId__Type"/> <xs:element name="cfName" type="cfMLangString__Type"/> </xs:sequence> </xs:complexType> </pre>

element **cfMeasName__Type/cfMeasId**

diagram							
namespace	urn:xmlns:org:eurocris:cerif-1.6-2						
type	cfId__Type						
properties	isRef 0 content simple						
facets	<table border="1"> <thead> <tr> <th>Kind</th> <th>Value</th> <th>annotation</th> </tr> </thead> <tbody> <tr> <td>maxLength</td> <td>128</td> <td></td> </tr> </tbody> </table>	Kind	Value	annotation	maxLength	128	
Kind	Value	annotation					
maxLength	128						
source	<code><xs:element name="cfMeasId" type="cfId__Type"/></code>						

element **cfMeasName__Type/cfName**

diagram																			
namespace	urn.xmlns:org:eurocris:cerif-1.6-2																		
type	cfMLangString__Type																		
properties	isRef 0 content complex																		
attributes	<table border="1"> <thead> <tr> <th>Name</th> <th>Type</th> <th>Use</th> <th>Default</th> <th>Fixed</th> <th>annotation</th> </tr> </thead> <tbody> <tr> <td>cfLangCode</td> <td>xs:string</td> <td>required</td> <td></td> <td></td> <td></td> </tr> <tr> <td>cfTrans</td> <td>cfTrans__Type</td> <td>required</td> <td></td> <td></td> <td></td> </tr> </tbody> </table>	Name	Type	Use	Default	Fixed	annotation	cfLangCode	xs:string	required				cfTrans	cfTrans__Type	required			
Name	Type	Use	Default	Fixed	annotation														
cfLangCode	xs:string	required																	
cfTrans	cfTrans__Type	required																	
source	<code><xs:element name="cfName" type="cfMLangString__Type"/></code>																		

complexType **cfMetrics__Type**

diagram	
namespace	urn.xmlns:org:eurocris:cerif-1.6-2
children	cfMetricsId cfURI cfName cfDescr cfKeyw cfMetrics_Class cfResPubl_Metrics cfFedId
used by	element CERIF/cfMetrics
source	<pre> <xs:complexType name="cfMetrics__Type"> <xs:sequence> <xs:element name="cfMetricsId" type="cfId__Type"/> <xs:element name="cfURI" type="xs:string" minOccurs="0"/> <xs:choice minOccurs="0" maxOccurs="unbounded"> <!-- embedded multiple-language attributes --> <xs:element name="cfName" type="cfMLangString__Type"/> <xs:element name="cfDescr" type="cfMLangString__Type"/> <xs:element name="cfKeyw" type="cfMLangString__Type"/> <!-- embedded linking entities --> <xs:element name="cfMetrics_Class" type="cfCoreClassWithFraction__Type"/> <xs:element name="cfResPubl_Metrics"/> </xs:choice> </xs:sequence> </xs:complexType> </pre>

	<pre> <xs:element name="cfYear" type="xs:int" minOccurs="0"/> <xs:element name="cfCount" type="xs:float" minOccurs="0"/> </xs:sequence> </xs:complexType> </xs:element> <!-- embedded federated identifiers --> <xs:element name="cfFedId" type="cfFedId__EmbType"/> </xs:choice> </xs:sequence> </xs:complexType> </pre>
--	---

element cfMetrics__Type/cfMetricsId

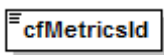
diagram	
namespace	urn:xmlns:org:eurocris:cerif-1.6-2
type	cfd__Type
properties	isRef 0 content simple
facets	Kind Value annotation maxLength 128
source	<pre><xs:element name="cfMetricsId" type="cfd__Type"/></pre>

element cfMetrics__Type/cfURI

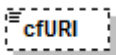
diagram	
namespace	urn:xmlns:org:eurocris:cerif-1.6-2
type	xs:string
properties	isRef 0 minOcc 0 maxOcc 1 content simple
source	<pre><xs:element name="cfURI" type="xs:string" minOccurs="0"/></pre>

element cfMetrics__Type/cfName

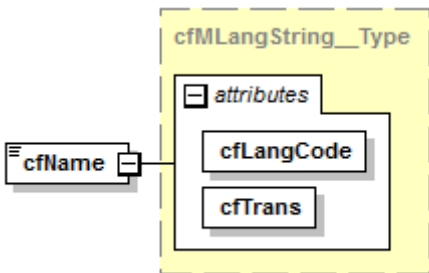
diagram																			
namespace	urn:xmlns:org:eurocris:cerif-1.6-2																		
type	cfMLangString__Type																		
properties	isRef 0 content complex																		
attributes	<table border="1"> <thead> <tr> <th>Name</th> <th>Type</th> <th>Use</th> <th>Default</th> <th>Fixed</th> <th>annotation</th> </tr> </thead> <tbody> <tr> <td>cfLangCode</td> <td>xs:string</td> <td>required</td> <td></td> <td></td> <td></td> </tr> <tr> <td>cfTrans</td> <td>cfTrans__Type</td> <td>required</td> <td></td> <td></td> <td></td> </tr> </tbody> </table>	Name	Type	Use	Default	Fixed	annotation	cfLangCode	xs:string	required				cfTrans	cfTrans__Type	required			
Name	Type	Use	Default	Fixed	annotation														
cfLangCode	xs:string	required																	
cfTrans	cfTrans__Type	required																	
source	<pre><xs:element name="cfName" type="cfMLangString__Type"/></pre>																		

element **cfMetrics__Type/cfDescr**

diagram						
namespace	urn:xmlns:org:eurocris:cerif-1.6-2					
type	cfMLangString__Type					
properties	isRef	0	content	complex		
attributes	Name	Type	Use	Default	Fixed	annotation
	cfLangCode	xs:string	required			
	cfTrans	cfTrans__Type	required			
source	<code><xs:element name="cfDescr" type="cfMLangString__Type"/></code>					

element **cfMetrics__Type/cfKeyw**

diagram						
namespace	urn:xmlns:org:eurocris:cerif-1.6-2					
type	cfMLangString__Type					
properties	isRef	0	content	complex		
attributes	Name	Type	Use	Default	Fixed	annotation
	cfLangCode	xs:string	required			
	cfTrans	cfTrans__Type	required			
source	<code><xs:element name="cfKeyw" type="cfMLangString__Type"/></code>					

element **cfMetrics__Type/cfMetrics_Class**

diagram						
namespace	urn:xmlns:org:eurocris:cerif-1.6-2					
type	cfCoreClassWithFraction__Type					
properties	isRef	0	content	complex		

children	cfClassId cfClassSchemeId cfStartDate cfEndDate cfFraction
source	<xs:element name="cfMetrics_Class" type="cfCoreClassWithFraction__Type"/>

element **cfMetrics__Type/cfResPubl_Metrics**

diagram	
namespace	urn.xmlns:org:eurocris:cerif-1.6-2
properties	isRef 0 content complex
children	cfResPublId cfClassId cfClassSchemeId cfStartDate cfEndDate cfFraction cfYear cfCount
source	<pre><xs:element name="cfResPubl_Metrics"> <xs:complexType> <xs:sequence> <xs:element name="cfResPublId" type="cfId__Type"/> <xs:group ref="cfCoreClassWithFraction__Group"/> <xs:element name="cfYear" type="xs:int" minOccurs="0"/> <xs:element name="cfCount" type="xs:float" minOccurs="0"/> </xs:sequence> </xs:complexType> </xs:element></pre>

element **cfMetrics__Type/cfResPubl_Metrics/cfResPublId**

diagram	
namespace	urn.xmlns:org:eurocris:cerif-1.6-2
type	cfId__Type
properties	isRef 0 content simple
facets	Kind Value annotation maxLength 128
source	<xs:element name="cfResPublId" type="cfId__Type"/>

element **cfMetrics__Type/cfResPubl_Metrics/cfYear**

diagram	
namespace	urn.xmlns:org:eurocris:cerif-1.6-2
type	xs:int
properties	isRef 0 minOcc 0 maxOcc 1 content simple
source	<xs:element name="cfYear" type="xs:int" minOccurs="0"/>

element **cfMetrics_Type/cfResPubl_Metrics/cfCount**

diagram	
namespace	urn:xmlns:org:eurocris:cerif-1.6-2
type	xs:float
properties	isRef 0 minOcc 0 maxOcc 1 content simple
source	<xs:element name="cfCount" type="xs:float" minOccurs="0"/>

element **cfMetrics_Type/cfFedId**

diagram	
namespace	urn:xmlns:org:eurocris:cerif-1.6-2
type	cfFedId_EmbType
properties	isRef 0 content complex
children	cfFedIdId cfFedId cfClassId cfClassSchemeId cfStartDate cfEndDate cfFedId_Class
source	<xs:element name="cfFedId" type="cfFedId__EmbType"/>

complexType **cfMetrics_Class_Type**

diagram	
namespace	urn:xmlns:org:eurocris:cerif-1.6-2
children	cfMetricsId cfClassId cfClassSchemeId cfStartDate cfEndDate cfFraction
used by	element CERIF/cfMetrics_Class
source	<xs:complexType name="cfMetrics_Class_Type">

	<pre><xs:sequence> <xs:element name="cfMetricsId" type="cfId__Type"/> <xs:group ref="cfCoreClassWithFraction__Group"/> </xs:sequence> </xs:complexType></pre>
--	---

element **cfMetrics_Class_Type/cfMetricsId**

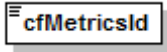
diagram	
namespace	urn:xmlns:org:eurocris:cerif-1.6-2
type	cfId__Type
properties	isRef 0 content simple
facets	Kind Value annotation maxLength 128
source	<pre><xs:element name="cfMetricsId" type="cfId__Type"/></pre>

complexType **cfMetricsDescr__Type**

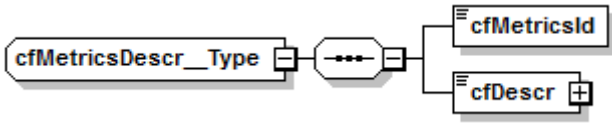
diagram	
namespace	urn:xmlns:org:eurocris:cerif-1.6-2
children	cfMetricsId cfDescr
used by	element CERIF/cfMetricsDescr
source	<pre><xs:complexType name="cfMetricsDescr__Type"> <xs:sequence> <xs:element name="cfMetricsId" type="cfId__Type"/> <xs:element name="cfDescr" type="cfMLangString__Type"/> </xs:sequence> </xs:complexType></pre>

element **cfMetricsDescr__Type/cfMetricsId**

diagram	
namespace	urn:xmlns:org:eurocris:cerif-1.6-2
type	cfId__Type
properties	isRef 0 content simple
facets	Kind Value annotation maxLength 128
source	<pre><xs:element name="cfMetricsId" type="cfId__Type"/></pre>

element **cfMetricsDescr__Type/cfDescr**

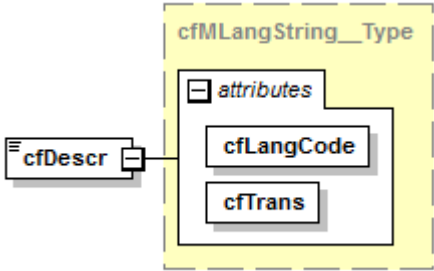
diagram																			
namespace	urn:xmlns:org:eurocris:cerif-1.6-2																		
type	cfMLangString__Type																		
properties	isRef 0 content complex																		
attributes	<table border="1"> <thead> <tr> <th>Name</th> <th>Type</th> <th>Use</th> <th>Default</th> <th>Fixed</th> <th>annotation</th> </tr> </thead> <tbody> <tr> <td>cfLangCode</td> <td>xs:string</td> <td>required</td> <td></td> <td></td> <td></td> </tr> <tr> <td>cfTrans</td> <td>cfTrans__Type</td> <td>required</td> <td></td> <td></td> <td></td> </tr> </tbody> </table>	Name	Type	Use	Default	Fixed	annotation	cfLangCode	xs:string	required				cfTrans	cfTrans__Type	required			
Name	Type	Use	Default	Fixed	annotation														
cfLangCode	xs:string	required																	
cfTrans	cfTrans__Type	required																	
source	<code><xs:element name="cfDescr" type="cfMLangString__Type"/></code>																		

complexType **cfMetricsKeyw__Type**

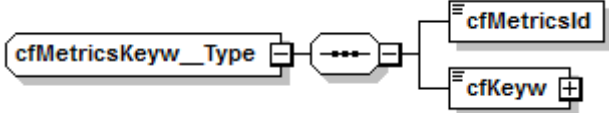
diagram	
namespace	urn:xmlns:org:eurocris:cerif-1.6-2
children	cfMetricsId cfKeyw
used by	element CERIF/cfMetricsKeyw
source	<code><xs:complexType name="cfMetricsKeyw__Type"> <xs:sequence> <xs:element name="cfMetricsId" type="cfId__Type"/> <xs:element name="cfKeyw" type="cfMLangString__Type"/> </xs:sequence> </xs:complexType></code>

element **cfMetricsKeyw__Type/cfMetricsId**

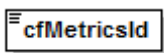
diagram							
namespace	urn:xmlns:org:eurocris:cerif-1.6-2						
type	cfId__Type						
properties	isRef 0 content simple						
facets	<table border="1"> <thead> <tr> <th>Kind</th> <th>Value</th> <th>annotation</th> </tr> </thead> <tbody> <tr> <td>maxLength</td> <td>128</td> <td></td> </tr> </tbody> </table>	Kind	Value	annotation	maxLength	128	
Kind	Value	annotation					
maxLength	128						
source	<code><xs:element name="cfMetricsId" type="cfId__Type"/></code>						

element **cfMetricsKeyw__Type/cfKeyw**

diagram																			
namespace	urn:xmlns:org:eurocris:cerif-1.6-2																		
type	cfMLangString__Type																		
properties	isRef 0 content complex																		
attributes	<table border="1"> <thead> <tr> <th>Name</th> <th>Type</th> <th>Use</th> <th>Default</th> <th>Fixed</th> <th>annotation</th> </tr> </thead> <tbody> <tr> <td>cfLangCode</td> <td>xs:string</td> <td>required</td> <td></td> <td></td> <td></td> </tr> <tr> <td>cfTrans</td> <td>cfTrans__Type</td> <td>required</td> <td></td> <td></td> <td></td> </tr> </tbody> </table>	Name	Type	Use	Default	Fixed	annotation	cfLangCode	xs:string	required				cfTrans	cfTrans__Type	required			
Name	Type	Use	Default	Fixed	annotation														
cfLangCode	xs:string	required																	
cfTrans	cfTrans__Type	required																	
source	<code><xs:element name="cfKeyw" type="cfMLangString__Type"/></code>																		

complexType **cfMetricsName__Type**

diagram	
namespace	urn:xmlns:org:eurocris:cerif-1.6-2
children	cfMetricsId cfName
used by	element CERIF/cfMetricsName
source	<pre> <xs:complexType name="cfMetricsName__Type"> <xs:sequence> <xs:element name="cfMetricsId" type="cfId__Type"/> <xs:element name="cfName" type="cfMLangString__Type"/> </xs:sequence> </xs:complexType> </pre>

element **cfMetricsName__Type/cfMetricsId**

diagram							
namespace	urn:xmlns:org:eurocris:cerif-1.6-2						
type	cfId__Type						
properties	isRef 0 content simple						
facets	<table border="1"> <thead> <tr> <th>Kind</th> <th>Value</th> <th>annotation</th> </tr> </thead> <tbody> <tr> <td>maxLength</td> <td>128</td> <td></td> </tr> </tbody> </table>	Kind	Value	annotation	maxLength	128	
Kind	Value	annotation					
maxLength	128						
source	<code><xs:element name="cfMetricsId" type="cfId__Type"/></code>						

element **cfMetricsName** Type/cfName

diagram						
namespace	urn:xmlns:org:eurocris:cerif-1.6-2					
type	cfMLangString_Type					
properties	isRef	0	content	complex		
attributes	Name	Type	Use	Default	Fixed	annotation
	cfLangCode	xs:string	required			
	cfTrans	cfTrans_Type	required			
source	<code><xs:element name="cfName" type="cfMLangString_Type"/></code>					

complexType **cfMLangString_Type**

diagram						
namespace	urn:xmlns:org:eurocris:cerif-1.6-2					
type	extension of xs:string					
properties	base	xs:string				
used by	elements	cfResPublAbstr_Type/cfAbstr cfProjAbstr_Type/cfAbstr cfProj_Type/cfAbstr cfResPubl_Type/cfAbstr cfResPubl_Type/cfBiblNote cfResPublBiblNote_Type/cfBiblNote cfClassScheme_Type/cfClass/cfDef cfClass_Type/cfDef cfClassDef_Type/cfDef cfClass_Type/cfDefSrc cfClassScheme_Type/cfClass/cfDefSrc cfClassDef_Type/cfDefSrc cfClass_Type/cfDescr cfEventDescr_Type/cfDescr cfFundDescr_Type/cfDescr cfQual_Type/cfDescr cfQualDescr_Type/cfDescr cfFund_Type/cfDescr cfClassScheme_Type/cfDescr cfCite_Type/cfDescr cfClassScheme_Type/cfClass/cfDescr cfIndicDescr_Type/cfDescr cfCiteDescr_Type/cfDescr cfClassSchemeDescr_Type/cfDescr cfMeasDescr_Type/cfDescr cfClassDescr_Type/cfDescr cfIndic_Type/cfDescr cfMeas_Type/cfDescr cfMetricsDescr_Type/cfDescr cfMetrics_Type/cfDescr cfEvent_Type/cfDescr cfClass_Type/cfDescrSrc cfClassScheme_Type/cfDescrSrc cfClassDescr_Type/cfDescrSrc cfClassSchemeDescr_Type/cfDescrSrc cfClassScheme_Type/cfClass/cfDescrSrc cfCurrency_Type/cfEntName cfCurrencyEntName_Type/cfEntName cfClass_Type/cfEx cfClassEx_Type/cfEx cfClassScheme_Type/cfClass/cfEx cfClass_Type/cfExSrc cfClassScheme_Type/cfClass/cfExSrc cfClassEx_Type/cfExSrc cfMetrics_Type/cfKeyw cfMetricsKeyw_Type/cfKeyw cfMeas_Type/cfKeyw cfIndic_Type/cfKeyw cfIndicKeyw_Type/cfKeyw cfMeasKeyw_Type/cfKeyw cfEvent_Type/cfKeyw cfEventKeyw_Type/cfKeyw cfFund_Type/cfKeyw cfFundKeyw_Type/cfKeyw cfOrgUnit_Type/cfKeyw cfOrgUnitKeyw_Type/cfKeyw cfPers_Type/cfKeyw cfPersKeyw_Type/cfKeyw cfResPublKeyw_Type/cfKeyw cfProj_Type/cfKeyw cfProjKeyw_Type/cfKeyw cfResPubl_Type/cfKeyw cfQual_Type/cfKeyw cfQualKeyw_Type/cfKeyw cfMeasName_Type/cfName cfLangName_Type/cfName cfClassScheme_Type/cfName cfMeas_Type/cfName cfFundName_Type/cfName cfCurrency_Type/cfName cfOrgUnitName_Type/cfName cfCurrencyName_Type/cfName cfIndicName_Type/cfName cfCountryName_Type/cfName cfOrgUnit_Type/cfName cfIndic_Type/cfName cfFund_Type/cfName cfMetricsName_Type/cfName cfEventName_Type/cfName cfMetrics_Type/cfName cfEvent_Type/cfName cfCountry_Type/cfName cfLang_Type/cfName cfClassSchemeName_Type/cfName cfResPublNameAbbrev_Type/cfNameAbbrev cfResPubl_Type/cfNameAbbrev cfClassScheme_Type/cfNameSrc cfClassSchemeName_Type/cfNameSrc cfOrgUnit_Type/cfResAct cfOrgUnitResAct_Type/cfResAct cfPers_Type/cfResInt cfPersResInt_Type/cfResInt cfClass_Type/cfRoleExpr cfClassScheme_Type/cfClass/cfRoleExpr cfClassTerm_Type/cfRoleExpr				

	cfClass_Type/cfRoleExprOpp cfClassScheme_Type/cfClass/cfRoleExprOpp cfClassTerm_Type/cfRoleExprOpp cfResPublSubtitle_Type/cfSubtitle cfResPubl_Type/cfSubtitle cfClassTerm_Type/cfTerm cfClass_Type/cfTerm cfClassScheme_Type/cfClass/cfTerm cfClassTerm_Type/cfTermSrc cfClass_Type/cfTermSrc cfClassScheme_Type/cfClass/cfTermSrc cfProj_Type/cfTitle cfResPubl_Type/cfTitle cfQual_Type/cfTitle cfProjTitle_Type/cfTitle cfResPublTitle_Type/cfTitle cfCiteTitle_Type/cfTitle cfCite_Type/cfTitle cfQualTitle_Type/cfTitle cfResPubl_Type/cfVersInfo cfResPublVersInfo_Type/cfVersInfo					
attributes	Name	Type	Use	Default	Fixed	annotation
	cfLangCode	xs:string	required			
	cfTrans	cfTrans_Type	required			
source	<pre><xs:complexType name="cfMLangString__Type"> <xs:simpleContent> <xs:extension base="xs:string"> <xs:attribute name="cfLangCode" type="xs:string" use="required"/> <xs:attribute name="cfTrans" type="cfTrans__Type" use="required"/> </xs:extension> </xs:simpleContent> </xs:complexType></pre>					

attribute **cfMLangString__Type/@cfLangCode**

type	xs:string
properties	isRef 0 use required
source	<pre><xs:attribute name="cfLangCode" type="xs:string" use="required"/></pre>

attribute **cfMLangString__Type/@cfTrans**

type	cfTrans_Type												
properties	isRef 0 use required												
facets	<table border="0"> <tr> <td>Kind</td> <td>Value</td> <td>annotation</td> </tr> <tr> <td>enumeration</td> <td>o</td> <td>documentation Value in the original language</td> </tr> <tr> <td>enumeration</td> <td>h</td> <td>documentation Human-translated value</td> </tr> <tr> <td>enumeration</td> <td>m</td> <td>documentation Machine-translated value</td> </tr> </table>	Kind	Value	annotation	enumeration	o	documentation Value in the original language	enumeration	h	documentation Human-translated value	enumeration	m	documentation Machine-translated value
Kind	Value	annotation											
enumeration	o	documentation Value in the original language											
enumeration	h	documentation Human-translated value											
enumeration	m	documentation Machine-translated value											
source	<pre><xs:attribute name="cfTrans" type="cfTrans__Type" use="required"/></pre>												

complexType cfOrgUnit__Type

<p>diagram</p>	
<p>namespace</p>	<p>urn:xmlns:org:eurocris:cerif-1.6-2</p>
<p>children</p>	<p>cfOrgUnitId cfAcro cfHeadcount cfTurn cfURI cfName cfResAct cfKeyw cfOrgUnit_Class cfOrgUnit_EAddr cfOrgUnit_Event cfOrgUnit_Fund cfOrgUnit_OrgUnit cfOrgUnit_ResPubl cfPers_OrgUnit cfProj_OrgUnit cfOrgUnit_PAddr cfOrgUnit_DC cfOrgUnit_Meas cfOrgUnit_Indic cfFedId</p>
<p>used by</p>	<p>element CERIF/cfOrgUnit</p>
<p>source</p>	<pre><xs:complexType name="cfOrgUnit__Type"> <xs:sequence> <xs:element name="cfOrgUnitId" type="cfId__Type"/> <xs:element name="cfAcro" type="xs:string" minOccurs="0"/> <xs:element name="cfHeadcount" type="xs:int" minOccurs="0"/> <xs:element name="cfTurn" type="cfAmount__Type" minOccurs="0"/> <xs:element name="cfURI" type="xs:string" minOccurs="0"/> <xs:choice minOccurs="0" maxOccurs="unbounded"> <!-- embedded multiple-language attributes --> </pre>

```

<xs:element name="cfName" type="cfMLangString__Type"/>
<xs:element name="cfResAct" type="cfMLangString__Type"/>
<xs:element name="cfKeyw" type="cfMLangString__Type"/>
<!-- embedded linking entities -->
<xs:element name="cfOrgUnit_Class" type="cfCoreClassWithFraction__Type"/>
<xs:element name="cfOrgUnit_EAddr">
  <xs:complexType>
    <xs:sequence>
      <xs:element name="cfEAddrId" type="cfId__Type"/>
      <xs:group ref="cfCoreClassWithFraction__Group"/>
    </xs:sequence>
  </xs:complexType>
</xs:element>
<xs:element name="cfOrgUnit_Event">
  <xs:complexType>
    <xs:sequence>
      <xs:element name="cfEventId" type="cfId__Type"/>
      <xs:group ref="cfCoreClassWithFraction__Group"/>
    </xs:sequence>
  </xs:complexType>
</xs:element>
<xs:element name="cfOrgUnit_Fund">
  <xs:complexType>
    <xs:sequence>
      <xs:element name="cfFundId" type="cfId__Type"/>
      <xs:group ref="cfCoreClassWithFraction__Group"/>
      <xs:element name="cfAmount" type="cfAmount__Type" minOccurs="0"/>
    </xs:sequence>
  </xs:complexType>
</xs:element>
<xs:element name="cfOrgUnit_OrgUnit">
  <xs:complexType>
    <xs:sequence>
      <xs:choice>
        <xs:element name="cfOrgUnitId2" type="cfId__Type"/>
        <xs:element name="cfOrgUnitId1" type="cfId__Type"/>
      </xs:choice>
      <xs:group ref="cfCoreClassWithFraction__Group"/>
    </xs:sequence>
  </xs:complexType>
</xs:element>
<xs:element name="cfOrgUnit_ResPubl">
  <xs:complexType>
    <xs:sequence>
      <xs:element name="cfResPublId" type="cfId__Type"/>
      <xs:group ref="cfCoreClassWithFraction__Group"/>
      <xs:element name="cfCopyright" type="xs:string" minOccurs="0"/>
      <xs:element name="cfOrder" type="xs:int" minOccurs="0"/>
    </xs:sequence>
  </xs:complexType>
</xs:element>
<xs:element name="cfPers_OrgUnit">
  <xs:complexType>
    <xs:sequence>
      <xs:element name="cfPersId" type="cfId__Type"/>
      <xs:group ref="cfCoreClassWithFraction__Group"/>
    </xs:sequence>
  </xs:complexType>
</xs:element>
<xs:element name="cfProj_OrgUnit">
  <xs:complexType>
    <xs:sequence>

```

	<pre> <xs:element name="cfProjld" type="cflD__Type"/> <xs:group ref="cfCoreClassWithFraction__Group"/> </xs:sequence> </xs:complexType> </xs:element> <xs:element name="cfOrgUnit_PAddr"> <xs:complexType> <xs:sequence> <xs:element name="cfPAddrld" type="cflD__Type"/> <xs:group ref="cfCoreClassWithFraction__Group"/> </xs:sequence> </xs:complexType> </xs:element> <xs:element name="cfOrgUnit_DC"> <xs:complexType> <xs:sequence> <xs:sequence> <xs:element name="cfDCld" type="xs:string"/> <xs:element name="cfDCScheme" type="xs:string"/> </xs:sequence> <xs:group ref="cfCoreClassWithFraction__Group"/> </xs:sequence> </xs:complexType> </xs:element> <xs:element name="cfOrgUnit_Meas"> <xs:complexType> <xs:sequence> <xs:element name="cfMeasld" type="cflD__Type"/> <xs:group ref="cfCoreClassWithFraction__Group"/> </xs:sequence> </xs:complexType> </xs:element> <xs:element name="cfOrgUnit_Indic"> <xs:complexType> <xs:sequence> <xs:element name="cfIndicld" type="cflD__Type"/> <xs:group ref="cfCoreClassWithFraction__Group"/> </xs:sequence> </xs:complexType> </xs:element> <!-- embedded federated identifiers --> <xs:element name="cfFedld" type="cfFedld__EmbType"/> </xs:choice> </xs:sequence> </xs:complexType> </pre>
--	--

element **cfOrgUnit__Type/cfOrgUnitld**

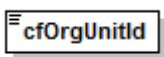
diagram	
namespace	urn:xmlns:org:eurocris:cerif-1.6-2
type	cflD__Type
properties	isRef 0 content simple
facets	Kind Value annotation maxLength 128
source	<pre><xs:element name="cfOrgUnitld" type="cflD__Type"/></pre>

element **cfOrgUnit_Type/cfAcro**

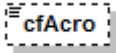
diagram	
namespace	urn:xmlns:org:eurocris:cerif-1.6-2
type	xs:string
properties	isRef 0 minOcc 0 maxOcc 1 content simple
source	<code><xs:element name="cfAcro" type="xs:string" minOccurs="0"/></code>

element **cfOrgUnit_Type/cfHeadcount**

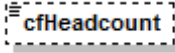
diagram	
namespace	urn:xmlns:org:eurocris:cerif-1.6-2
type	xs:int
properties	isRef 0 minOcc 0 maxOcc 1 content simple
source	<code><xs:element name="cfHeadcount" type="xs:int" minOccurs="0"/></code>

element **cfOrgUnit_Type/cfTurn**

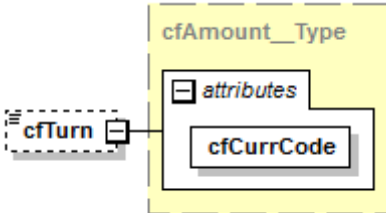
diagram													
namespace	urn:xmlns:org:eurocris:cerif-1.6-2												
type	cfAmount_Type												
properties	isRef 0 minOcc 0 maxOcc 1 content complex												
attributes	<table border="1"> <thead> <tr> <th>Name</th> <th>Type</th> <th>Use</th> <th>Default</th> <th>Fixed</th> <th>annotation</th> </tr> </thead> <tbody> <tr> <td>cfCurrCode</td> <td>xs:string</td> <td>required</td> <td></td> <td></td> <td></td> </tr> </tbody> </table>	Name	Type	Use	Default	Fixed	annotation	cfCurrCode	xs:string	required			
Name	Type	Use	Default	Fixed	annotation								
cfCurrCode	xs:string	required											
source	<code><xs:element name="cfTurn" type="cfAmount_Type" minOccurs="0"/></code>												

element **cfOrgUnit_Type/cfURI**

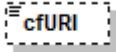
diagram	
namespace	urn:xmlns:org:eurocris:cerif-1.6-2
type	xs:string
properties	isRef 0 minOcc 0 maxOcc 1 content simple
source	<code><xs:element name="cfURI" type="xs:string" minOccurs="0"/></code>

element **cfOrgUnit__Type/cfName**

diagram						
namespace	urn:xmlns:org:eurocris:cerif-1.6-2					
type	cfMLangString__Type					
properties	isRef	0	content	complex		
attributes	Name	Type	Use	Default	Fixed	annotation
	cfLangCode	xs:string	required			
	cfTrans	cfTrans__Type	required			
source	<code><xs:element name="cfName" type="cfMLangString__Type"/></code>					

element **cfOrgUnit__Type/cfResAct**

diagram						
namespace	urn:xmlns:org:eurocris:cerif-1.6-2					
type	cfMLangString__Type					
properties	isRef	0	content	complex		
attributes	Name	Type	Use	Default	Fixed	annotation
	cfLangCode	xs:string	required			
	cfTrans	cfTrans__Type	required			
source	<code><xs:element name="cfResAct" type="cfMLangString__Type"/></code>					

element **cfOrgUnit__Type/cfKeyw**

diagram						
namespace	urn:xmlns:org:eurocris:cerif-1.6-2					
type	cfMLangString__Type					
properties	isRef	0	content	complex		

attributes	Name	Type	Use	Default	Fixed	annotation
	cfLangCode	xs:string	required			
	cfTrans	cfTrans_Type	required			
source	<code><xs:element name="cfKeyw" type="cfMLangString__Type"/></code>					

element cfOrgUnit_Type/cfOrgUnit_Class

diagram	
namespace	urn:xmlns:org:eurocris:cerif-1.6-2
type	cfCoreClassWithFraction_Type
properties	isRef 0 content complex
children	cfClassId cfClassSchemeld cfStartDate cfEndDate cfFraction
source	<code><xs:element name="cfOrgUnit_Class" type="cfCoreClassWithFraction__Type"/></code>

element cfOrgUnit_Type/cfOrgUnit_EAddr

diagram	
namespace	urn:xmlns:org:eurocris:cerif-1.6-2
properties	isRef 0 content complex
children	cfEAddrId cfClassId cfClassSchemeld cfStartDate cfEndDate cfFraction
source	<pre> <xs:element name="cfOrgUnit_EAddr"> <xs:complexType> <xs:sequence> <xs:element name="cfEAddrId" type="cfId__Type"/> <xs:group ref="cfCoreClassWithFraction__Group"/> </xs:sequence> </xs:complexType> </xs:element> </pre>

element cfOrgUnit_Type/cfOrgUnit_EAddr/cfEAddrId

diagram	
namespace	urn:xmlns:org:eurocris:cerif-1.6-2
type	cfId_Type

properties	isRef 0 content simple
facets	Kind Value annotation maxLength 128
source	<xs:element name="cfEAddrId" type="cfId__Type"/>

element cfOrgUnit__Type/cfOrgUnit_Event

diagram	
namespace	urn:xmlns:org:eurocris:cerif-1.6-2
properties	isRef 0 content complex
children	cfEventId cfClassId cfClassSchemeld cfStartDate cfEndDate cfFraction
source	<pre><xs:element name="cfOrgUnit_Event"> <xs:complexType> <xs:sequence> <xs:element name="cfEventId" type="cfId__Type"/> <xs:group ref="cfCoreClassWithFraction__Group"/> </xs:sequence> </xs:complexType> </xs:element></pre>

element cfOrgUnit__Type/cfOrgUnit_Event/cfEventId

diagram	
namespace	urn:xmlns:org:eurocris:cerif-1.6-2
type	cfId__Type
properties	isRef 0 content simple
facets	Kind Value annotation maxLength 128
source	<xs:element name="cfEventId" type="cfId__Type"/>

element cfOrgUnit__Type/cfOrgUnit_Fund

diagram	
namespace	urn:xmlns:org:eurocris:cerif-1.6-2

properties	isRef 0 content complex
children	cfFundId cfClassId cfClassSchemeId cfStartDate cfEndDate cfFraction cfAmount
source	<pre><xs:element name="cfOrgUnit_Fund"> <xs:complexType> <xs:sequence> <xs:element name="cfFundId" type="cfId__Type"/> <xs:group ref="cfCoreClassWithFraction__Group"/> <xs:element name="cfAmount" type="cfAmount__Type" minOccurs="0"/> </xs:sequence> </xs:complexType> </xs:element></pre>

element **cfOrgUnit__Type/cfOrgUnit_Fund/cfFundId**

diagram	
namespace	urn:xmlns:org:eurocris:cerif-1.6-2
type	cfId__Type
properties	isRef 0 content simple
facets	Kind Value annotation maxLength 128
source	<pre><xs:element name="cfFundId" type="cfId__Type"/></pre>

element **cfOrgUnit__Type/cfOrgUnit_Fund/cfAmount**

diagram													
namespace	urn:xmlns:org:eurocris:cerif-1.6-2												
type	cfAmount__Type												
properties	isRef 0 minOcc 0 maxOcc 1 content complex												
attributes	<table border="1"> <thead> <tr> <th>Name</th> <th>Type</th> <th>Use</th> <th>Default</th> <th>Fixed</th> <th>annotation</th> </tr> </thead> <tbody> <tr> <td>cfCurrCode</td> <td>xs:string</td> <td>required</td> <td></td> <td></td> <td></td> </tr> </tbody> </table>	Name	Type	Use	Default	Fixed	annotation	cfCurrCode	xs:string	required			
Name	Type	Use	Default	Fixed	annotation								
cfCurrCode	xs:string	required											
source	<pre><xs:element name="cfAmount" type="cfAmount__Type" minOccurs="0"/></pre>												

element **cfOrgUnit__Type/cfOrgUnit_OrgUnit**

diagram	
namespace	urn:xmlns:org:eurocris:cerif-1.6-2
properties	isRef 0 content complex
children	cfOrgUnitId2 cfOrgUnitId1 cfClassId cfClassSchemeld cfStartDate cfEndDate cfFraction
source	<pre><xs:element name="cfOrgUnit_OrgUnit"> <xs:complexType> <xs:sequence> <xs:choice> <xs:element name="cfOrgUnitId2" type="cflD__Type"/> <xs:element name="cfOrgUnitId1" type="cflD__Type"/> </xs:choice> <xs:group ref="cfCoreClassWithFraction__Group"/> </xs:sequence> </xs:complexType> </xs:element></pre>

element **cfOrgUnit__Type/cfOrgUnit_OrgUnit/cfOrgUnitId2**

diagram	
namespace	urn:xmlns:org:eurocris:cerif-1.6-2
type	cflD__Type
properties	isRef 0 content simple
facets	Kind Value annotation maxLength 128
source	<pre><xs:element name="cfOrgUnitId2" type="cflD__Type"/></pre>

element **cfOrgUnit__Type/cfOrgUnit_OrgUnit/cfOrgUnitId1**

diagram	
namespace	urn:xmlns:org:eurocris:cerif-1.6-2
type	cflD__Type
properties	isRef 0 content simple
facets	Kind Value annotation maxLength 128
source	<pre><xs:element name="cfOrgUnitId1" type="cflD__Type"/></pre>

element **cfOrgUnit_Type/cfOrgUnit_ResPubl**

diagram	
namespace	urn.xmlns:org:eurocris:cerif-1.6-2
properties	isRef 0 content complex
children	cfResPublId cfClassId cfClassSchemeld cfStartDate cfEndDate cfFraction cfCopyright cfOrder
source	<pre> <xs:element name="cfOrgUnit_ResPubl"> <xs:complexType> <xs:sequence> <xs:element name="cfResPublId" type="cfId__Type"/> <xs:group ref="cfCoreClassWithFraction__Group"/> <xs:element name="cfCopyright" type="xs:string" minOccurs="0"/> <xs:element name="cfOrder" type="xs:int" minOccurs="0"/> </xs:sequence> </xs:complexType> </xs:element> </pre>

element **cfOrgUnit_Type/cfOrgUnit_ResPubl/cfResPublId**

diagram							
namespace	urn.xmlns:org:eurocris:cerif-1.6-2						
type	cfId__Type						
properties	isRef 0 content simple						
facets	<table border="1"> <thead> <tr> <th>Kind</th> <th>Value</th> <th>annotation</th> </tr> </thead> <tbody> <tr> <td>maxLength</td> <td>128</td> <td></td> </tr> </tbody> </table>	Kind	Value	annotation	maxLength	128	
Kind	Value	annotation					
maxLength	128						
source	<pre><xs:element name="cfResPublId" type="cfId__Type"/></pre>						

element **cfOrgUnit_Type/cfOrgUnit_ResPubl/cfCopyright**

diagram									
namespace	urn.xmlns:org:eurocris:cerif-1.6-2								
type	xs:string								
properties	<table border="1"> <tbody> <tr> <td>isRef</td> <td>0</td> </tr> <tr> <td>minOcc</td> <td>0</td> </tr> <tr> <td>maxOcc</td> <td>1</td> </tr> <tr> <td>content</td> <td>simple</td> </tr> </tbody> </table>	isRef	0	minOcc	0	maxOcc	1	content	simple
isRef	0								
minOcc	0								
maxOcc	1								
content	simple								
source	<pre><xs:element name="cfCopyright" type="xs:string" minOccurs="0"/></pre>								

element cfOrgUnit_Type/cfOrgUnit_ResPubl/cfOrder

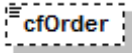
diagram	
namespace	urn:xmlns:org:eurocris:cerif-1.6-2
type	xs:int
properties	isRef 0 minOcc 0 maxOcc 1 content simple
source	<xs:element name="cfOrder" type="xs:int" minOccurs="0"/>

element cfOrgUnit_Type/cfPers_OrgUnit

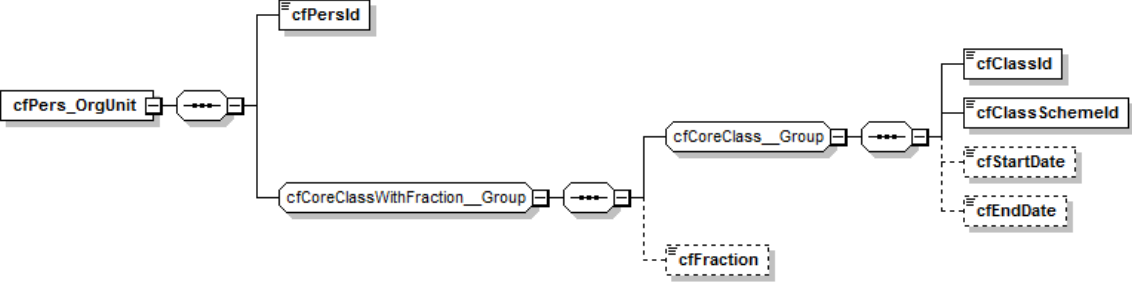
diagram	
namespace	urn:xmlns:org:eurocris:cerif-1.6-2
properties	isRef 0 content complex
children	cfPersId cfClassId cfClassSchemeld cfStartDate cfEndDate cfFraction
source	<xs:element name="cfPers_OrgUnit"> <xs:complexType> <xs:sequence> <xs:element name="cfPersId" type="cfId__Type"/> <xs:group ref="cfCoreClassWithFraction__Group"/> </xs:sequence> </xs:complexType> </xs:element>

element cfOrgUnit_Type/cfPers_OrgUnit/cfPersId

diagram	
namespace	urn:xmlns:org:eurocris:cerif-1.6-2
type	cfId__Type
properties	isRef 0 content simple
facets	Kind Value annotation maxLength 128
source	<xs:element name="cfPersId" type="cfId__Type"/>

element **cfOrgUnit_Type/cfProj_OrgUnit**

diagram	
namespace	urn.xmlns:org:eurocris:cerif-1.6-2
properties	isRef 0 content complex
children	cfProjId cfClassId cfClassSchemeld cfStartDate cfEndDate cfFraction
source	<pre><xs:element name="cfProj_OrgUnit"> <xs:complexType> <xs:sequence> <xs:element name="cfProjId" type="cflD__Type"/> <xs:group ref="cfCoreClassWithFraction__Group"/> </xs:sequence> </xs:complexType> </xs:element></pre>

element **cfOrgUnit_Type/cfProj_OrgUnit/cfProjId**

diagram	
namespace	urn.xmlns:org:eurocris:cerif-1.6-2
type	cflD__Type
properties	isRef 0 content simple
facets	Kind Value annotation maxLength 128
source	<pre><xs:element name="cfProjId" type="cflD__Type"/></pre>

element **cfOrgUnit_Type/cfOrgUnit_PAddr**

diagram	
namespace	urn.xmlns:org:eurocris:cerif-1.6-2
properties	isRef 0 content complex
children	cfPAddrId cfClassId cfClassSchemeld cfStartDate cfEndDate cfFraction
source	<pre><xs:element name="cfOrgUnit_PAddr"> <xs:complexType> <xs:sequence> <xs:element name="cfPAddrId" type="cflD__Type"/> <xs:group ref="cfCoreClassWithFraction__Group"/> </xs:sequence> </xs:complexType> </xs:element></pre>

	<pre></xs:complexType> </xs:element></pre>
--	--

element **cfOrgUnit__Type/cfOrgUnit_PAddr/cfPAddrId**

diagram	
namespace	urn:xmlns:org:eurocris:cerif-1.6-2
type	cflD_Type
properties	isRef 0 content simple
facets	Kind Value annotation maxLength 128
source	<pre><xs:element name="cfPAddrId" type="cflD_Type"/></pre>

element **cfOrgUnit__Type/cfOrgUnit_DC**

diagram	
namespace	urn:xmlns:org:eurocris:cerif-1.6-2
properties	isRef 0 content complex
children	cfDCId cfDCScheme cfClassId cfClassSchemeId cfStartDate cfEndDate cfFraction
source	<pre><xs:element name="cfOrgUnit_DC"> <xs:complexType> <xs:sequence> <xs:sequence> <xs:element name="cfDCId" type="xs:string"/> <xs:element name="cfDCScheme" type="xs:string"/> </xs:sequence> <xs:group ref="cfCoreClassWithFraction__Group"/> </xs:sequence> </xs:complexType> </xs:element></pre>

element **cfOrgUnit__Type/cfOrgUnit_DC/cfDCId**

diagram	
namespace	urn:xmlns:org:eurocris:cerif-1.6-2
type	xs:string
properties	isRef 0 content simple
source	<pre><xs:element name="cfDCId" type="xs:string"/></pre>

element **cfOrgUnit_Type/cfOrgUnit_DC/cfDCScheme**

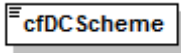
diagram	
namespace	urn:xmlns:org:eurocris:cerif-1.6-2
type	xs:string
properties	isRef 0 content simple
source	<code><xs:element name="cfDCScheme" type="xs:string"/></code>

element **cfOrgUnit_Type/cfOrgUnit_Meas**

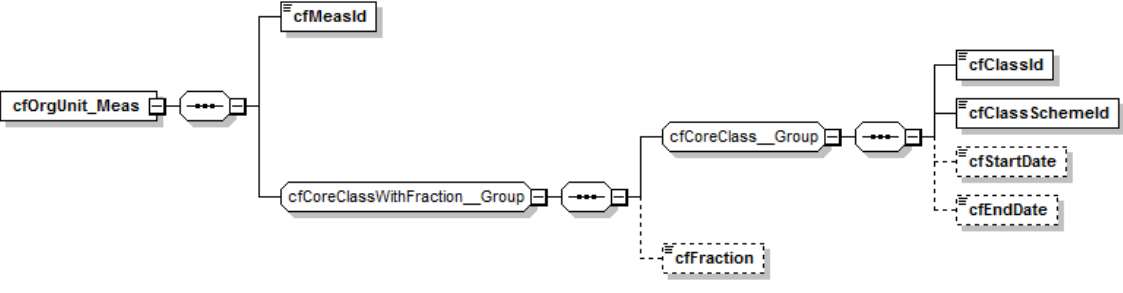
diagram	
namespace	urn:xmlns:org:eurocris:cerif-1.6-2
properties	isRef 0 content complex
children	cfMeasId cfClassId cfClassSchemeld cfStartDate cfEndDate cfFraction
source	<code><xs:element name="cfOrgUnit_Meas"> <xs:complexType> <xs:sequence> <xs:element name="cfMeasId" type="cfId__Type"/> <xs:group ref="cfCoreClassWithFraction__Group"/> </xs:sequence> </xs:complexType> </xs:element></code>

element **cfOrgUnit_Type/cfOrgUnit_Meas/cfMeasId**

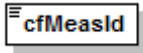
diagram	
namespace	urn:xmlns:org:eurocris:cerif-1.6-2
type	cfId__Type
properties	isRef 0 content simple
facets	Kind Value annotation maxLength 128
source	<code><xs:element name="cfMeasId" type="cfId__Type"/></code>

element **cfOrgUnit_Type/cfOrgUnit_Indic**

diagram	
namespace	urn:xmlns:org:eurocris:cerif-1.6-2
properties	isRef 0 content complex
children	cfIndicId cfClassId cfClassSchemeld cfStartDate cfEndDate cfFraction
source	<pre> <xs:element name="cfOrgUnit_Indic"> <xs:complexType> <xs:sequence> <xs:element name="cfIndicId" type="cfId__Type"/> <xs:group ref="cfCoreClassWithFraction__Group"/> </xs:sequence> </xs:complexType> </xs:element> </pre>

element **cfOrgUnit_Type/cfOrgUnit_Indic/cfIndicId**

diagram	
namespace	urn:xmlns:org:eurocris:cerif-1.6-2
type	cfId_Type
properties	isRef 0 content simple
facets	Kind Value annotation maxLength 128
source	<pre> <xs:element name="cfIndicId" type="cfId__Type"/> </pre>

element **cfOrgUnit_Type/cfFedId**

diagram	
namespace	urn:xmlns:org:eurocris:cerif-1.6-2

type	cfFedld_EmbType
properties	isRef 0 content complex
children	cfFedldId cfFedld cfClassId cfClassSchemeId cfStartDate cfEndDate cfFedld_Class
source	<code><xs:element name="cfFedld" type="cfFedld__EmbType"/></code>

complexType **cfOrgUnit_Class_Type**

diagram	
namespace	urn:xmlns:org:eurocris:cerif-1.6-2
children	cfOrgUnitId cfClassId cfClassSchemeId cfStartDate cfEndDate cfFraction
used by	element CERIF/cfOrgUnit_Class
source	<pre> <xs:complexType name="cfOrgUnit_Class_Type"> <xs:sequence> <xs:element name="cfOrgUnitId" type="cfld__Type"/> <xs:group ref="cfCoreClassWithFraction_Group"/> </xs:sequence> </xs:complexType> </pre>

element **cfOrgUnit_Class_Type/cfOrgUnitId**

diagram	
namespace	urn:xmlns:org:eurocris:cerif-1.6-2
type	cfld_Type
properties	isRef 0 content simple
facets	Kind Value annotation maxLength 128
source	<code><xs:element name="cfOrgUnitId" type="cfld__Type"/></code>

complexType **cfOrgUnit_DC_Type**

diagram	
namespace	urn:xmlns:org:eurocris:cerif-1.6-2
children	cfOrgUnitId cfDCId cfDCScheme cfClassId cfClassSchemeId cfStartDate cfEndDate cfFraction

used by	element CERIF/cfOrgUnit_DC
source	<pre><xs:complexType name="cfOrgUnit_DC__Type"> <xs:sequence> <xs:element name="cfOrgUnitId" type="cfId__Type"/> <xs:element name="cfDCId" type="xs:string"/> <xs:element name="cfDCScheme" type="xs:string"/> <xs:group ref="cfCoreClassWithFraction__Group"/> </xs:sequence> </xs:complexType></pre>

element cfOrgUnit_DC__Type/cfOrgUnitId

diagram	
namespace	urn:xmlns:org:eurocris:cerif-1.6-2
type	cfId__Type
properties	isRef 0 content simple
facets	Kind Value annotation maxLength 128
source	<pre><xs:element name="cfOrgUnitId" type="cfId__Type"/></pre>

element cfOrgUnit_DC__Type/cfDCId

diagram	
namespace	urn:xmlns:org:eurocris:cerif-1.6-2
type	xs:string
properties	isRef 0 content simple
source	<pre><xs:element name="cfDCId" type="xs:string"/></pre>

element cfOrgUnit_DC__Type/cfDCScheme

diagram	
namespace	urn:xmlns:org:eurocris:cerif-1.6-2
type	xs:string
properties	isRef 0 content simple
source	<pre><xs:element name="cfDCScheme" type="xs:string"/></pre>

complexType cfOrgUnit_EAddr__Type

diagram	
namespace	urn:xmlns:org:eurocris:cerif-1.6-2

children	cfOrgUnitId cfEAddrId cfClassId cfClassSchemeId cfStartDate cfEndDate cfFraction
used by	element CERIF/cfOrgUnit_EAddr
source	<pre><xs:complexType name="cfOrgUnit_EAddr__Type"> <xs:sequence> <xs:element name="cfOrgUnitId" type="cfId__Type"/> <xs:element name="cfEAddrId" type="cfId__Type"/> <xs:group ref="cfCoreClassWithFraction__Group"/> </xs:sequence> </xs:complexType></pre>

element **cfOrgUnit_EAddr__Type/cfOrgUnitId**

diagram	
namespace	urn:xmlns:org:eurocris:cerif-1.6-2
type	cfId__Type
properties	isRef 0 content simple
facets	Kind Value annotation maxLength 128
source	<pre><xs:element name="cfOrgUnitId" type="cfId__Type"/></pre>

element **cfOrgUnit_EAddr__Type/cfEAddrId**

diagram	
namespace	urn:xmlns:org:eurocris:cerif-1.6-2
type	cfId__Type
properties	isRef 0 content simple
facets	Kind Value annotation maxLength 128
source	<pre><xs:element name="cfEAddrId" type="cfId__Type"/></pre>

complexType **cfOrgUnit_Event__Type**

diagram	
namespace	urn:xmlns:org:eurocris:cerif-1.6-2
children	cfOrgUnitId cfEventId cfClassId cfClassSchemeId cfStartDate cfEndDate cfFraction
used by	element CERIF/cfOrgUnit_Event
source	<pre><xs:complexType name="cfOrgUnit_Event__Type"> <xs:sequence> <xs:element name="cfOrgUnitId" type="cfId__Type"/> <xs:element name="cfEventId" type="cfId__Type"/> <xs:group ref="cfCoreClassWithFraction__Group"/> </xs:sequence></pre>

	</xs:complexType>
--	-------------------

element cfOrgUnit_Event__Type/cfOrgUnitId

diagram	
namespace	urn:xmlns:org:eurocris:cerif-1.6-2
type	cfId_Type
properties	isRef 0 content simple
facets	Kind Value annotation maxLength 128
source	<xs:element name="cfOrgUnitId" type="cfId__Type"/>

element cfOrgUnit_Event__Type/cfEventId

diagram	
namespace	urn:xmlns:org:eurocris:cerif-1.6-2
type	cfId_Type
properties	isRef 0 content simple
facets	Kind Value annotation maxLength 128
source	<xs:element name="cfEventId" type="cfId__Type"/>

complexType cfOrgUnit_Fund__Type

diagram	
namespace	urn:xmlns:org:eurocris:cerif-1.6-2
children	cfOrgUnitId cfFundId cfClassId cfClassSchemeld cfStartDate cfEndDate cfFraction cfAmount
used by	element CERIF/cfOrgUnit_Fund
source	<pre> <xs:complexType name="cfOrgUnit_Fund__Type"> <xs:sequence> <xs:element name="cfOrgUnitId" type="cfId__Type"/> <xs:element name="cfFundId" type="cfId__Type"/> <xs:group ref="cfCoreClassWithFraction__Group"/> <xs:element name="cfAmount" type="cfAmount__Type" minOccurs="0"/> </xs:sequence> </xs:complexType> </pre>

element cfOrgUnit_Fund_Type/cfOrgUnitId

diagram	
namespace	urn:xmlns:org:eurocris:cerif-1.6-2
type	cfd_Type
properties	isRef 0 content simple
facets	Kind Value annotation maxLength 128
source	<code><xs:element name="cfOrgUnitId" type="cfd__Type"/></code>

element cfOrgUnit_Fund_Type/cfFundId

diagram	
namespace	urn:xmlns:org:eurocris:cerif-1.6-2
type	cfd_Type
properties	isRef 0 content simple
facets	Kind Value annotation maxLength 128
source	<code><xs:element name="cfFundId" type="cfd__Type"/></code>

element cfOrgUnit_Fund_Type/cfAmount

diagram													
namespace	urn:xmlns:org:eurocris:cerif-1.6-2												
type	cfAmount_Type												
properties	isRef 0 minOcc 0 maxOcc 1 content complex												
attributes	<table border="1"> <thead> <tr> <th>Name</th> <th>Type</th> <th>Use</th> <th>Default</th> <th>Fixed</th> <th>annotation</th> </tr> </thead> <tbody> <tr> <td>cfCurrCode</td> <td>xs:string</td> <td>required</td> <td></td> <td></td> <td></td> </tr> </tbody> </table>	Name	Type	Use	Default	Fixed	annotation	cfCurrCode	xs:string	required			
Name	Type	Use	Default	Fixed	annotation								
cfCurrCode	xs:string	required											
source	<code><xs:element name="cfAmount" type="cfAmount_Type" minOccurs="0"/></code>												

complexType cfOrgUnit_Indic_Type

diagram	
namespace	urn:xmlns:org:eurocris:cerif-1.6-2

children	cfOrgUnitId cfIndicId cfClassId cfClassSchemeId cfStartDate cfEndDate cfFraction
used by	element CERIF/cfOrgUnit_Indic
source	<pre><xs:complexType name="cfOrgUnit_Indic__Type"> <xs:sequence> <xs:element name="cfOrgUnitId" type="cfId__Type"/> <xs:element name="cfIndicId" type="cfId__Type"/> <xs:group ref="cfCoreClassWithFraction__Group"/> </xs:sequence> </xs:complexType></pre>

element **cfOrgUnit_Indic__Type/cfOrgUnitId**

diagram	
namespace	urn:xmlns:org:eurocris:cerif-1.6-2
type	cfId__Type
properties	isRef 0 content simple
facets	Kind Value annotation maxLength 128
source	<pre><xs:element name="cfOrgUnitId" type="cfId__Type"/></pre>

element **cfOrgUnit_Indic__Type/cfIndicId**

diagram	
namespace	urn:xmlns:org:eurocris:cerif-1.6-2
type	cfId__Type
properties	isRef 0 content simple
facets	Kind Value annotation maxLength 128
source	<pre><xs:element name="cfIndicId" type="cfId__Type"/></pre>

complexType **cfOrgUnit_Meas__Type**

diagram	
namespace	urn:xmlns:org:eurocris:cerif-1.6-2
children	cfOrgUnitId cfMeasId cfClassId cfClassSchemeId cfStartDate cfEndDate cfFraction
used by	element CERIF/cfOrgUnit_Meas
source	<pre><xs:complexType name="cfOrgUnit_Meas__Type"> <xs:sequence> <xs:element name="cfOrgUnitId" type="cfId__Type"/> <xs:element name="cfMeasId" type="cfId__Type"/> <xs:group ref="cfCoreClassWithFraction__Group"/> </xs:sequence></pre>

	<code></xs:complexType></code>
--	--------------------------------------

element cfOrgUnit_Meas_Type/cfOrgUnitId

diagram	
namespace	urn:xmlns:org:eurocris:cerif-1.6-2
type	cfd_Type
properties	isRef 0 content simple
facets	Kind Value annotation maxLength 128
source	<code><xs:element name="cfOrgUnitId" type="cfd__Type"/></code>

element cfOrgUnit_Meas_Type/cfMeasId

diagram	
namespace	urn:xmlns:org:eurocris:cerif-1.6-2
type	cfd_Type
properties	isRef 0 content simple
facets	Kind Value annotation maxLength 128
source	<code><xs:element name="cfMeasId" type="cfd__Type"/></code>

complexType cfOrgUnit_OrgUnit_Type

diagram	
namespace	urn:xmlns:org:eurocris:cerif-1.6-2
children	cfOrgUnitId1 cfOrgUnitId2 cfClassId cfClassSchemeId cfStartDate cfEndDate cfFraction
used by	element CERIF/cfOrgUnit_OrgUnit
source	<code><xs:complexType name="cfOrgUnit_OrgUnit_Type"> <xs:sequence> <xs:element name="cfOrgUnitId1" type="cfd__Type"/> <xs:element name="cfOrgUnitId2" type="cfd__Type"/> <xs:group ref="cfCoreClassWithFraction_Group"/> </xs:sequence> </xs:complexType></code>

element cfOrgUnit_OrgUnit_Type/cfOrgUnitId1

diagram	
namespace	urn:xmlns:org:eurocris:cerif-1.6-2
type	cfd_Type

properties	isRef 0 content simple
facets	Kind Value annotation maxLength 128
source	<xs:element name="cfOrgUnitId1" type="cflD__Type"/>

element cfOrgUnit_OrgUnit_Type/cfOrgUnitId2

diagram	
namespace	urn:xmlns:org:eurocris:cerif-1.6-2
type	cflD__Type
properties	isRef 0 content simple
facets	Kind Value annotation maxLength 128
source	<xs:element name="cfOrgUnitId2" type="cflD__Type"/>

complexType cfOrgUnit_PAddr_Type

diagram	
namespace	urn:xmlns:org:eurocris:cerif-1.6-2
children	cfOrgUnitId cfPAddrId cfClassId cfClassSchemId cfStartDate cfEndDate cfFraction
used by	element CERIF/cfOrgUnit_PAddr
source	<xs:complexType name="cfOrgUnit_PAddr_Type"> <xs:sequence> <xs:element name="cfOrgUnitId" type="cflD__Type"/> <xs:element name="cfPAddrId" type="cflD__Type"/> <xs:group ref="cfCoreClassWithFraction_Group"/> </xs:sequence> </xs:complexType>

element cfOrgUnit_PAddr_Type/cfOrgUnitId

diagram	
namespace	urn:xmlns:org:eurocris:cerif-1.6-2
type	cflD__Type
properties	isRef 0 content simple
facets	Kind Value annotation maxLength 128
source	<xs:element name="cfOrgUnitId" type="cflD__Type"/>

element **cfOrgUnit_PAddr_Type/cfPAddrId**

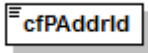
diagram	
namespace	urn:xmlns:org:eurocris:cerif-1.6-2
type	cfId_Type
properties	isRef 0 content simple
facets	Kind Value annotation maxLength 128
source	<code><xs:element name="cfPAddrId" type="cfId_Type"/></code>

complexType **cfOrgUnit_ResPubl_Type**

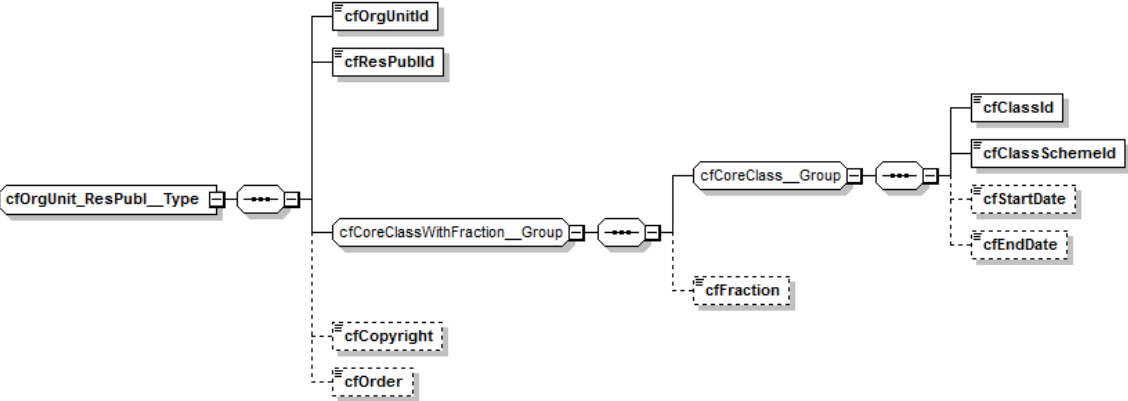
diagram	
namespace	urn:xmlns:org:eurocris:cerif-1.6-2
children	cfOrgUnitId cfResPublId cfClassId cfClassSchemeld cfStartDate cfEndDate cfFraction cfCopyright cfOrder
used by	element CERIF/cfOrgUnit_ResPubl
source	<pre><xs:complexType name="cfOrgUnit_ResPubl_Type"> <xs:sequence> <xs:element name="cfOrgUnitId" type="cfId_Type"/> <xs:element name="cfResPublId" type="cfId_Type"/> <xs:group ref="cfCoreClassWithFraction_Group"/> <xs:element name="cfCopyright" type="xs:string" minOccurs="0"/> <xs:element name="cfOrder" type="xs:int" minOccurs="0"/> </xs:sequence> </xs:complexType></pre>

element **cfOrgUnit_ResPubl_Type/cfOrgUnitId**

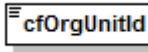
diagram	
namespace	urn:xmlns:org:eurocris:cerif-1.6-2
type	cfId_Type
properties	isRef 0 content simple
facets	Kind Value annotation maxLength 128
source	<code><xs:element name="cfOrgUnitId" type="cfId_Type"/></code>

element **cfOrgUnit_ResPubl__Type/cfResPublId**

diagram	
namespace	urn:xmlns:org:eurocris:cerif-1.6-2
type	cfd__Type
properties	isRef 0 content simple
facets	Kind Value annotation maxLength 128
source	<code><xs:element name="cfResPublId" type="cfd__Type"/></code>

element **cfOrgUnit_ResPubl__Type/cfCopyright**

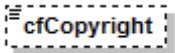
diagram	
namespace	urn:xmlns:org:eurocris:cerif-1.6-2
type	xs:string
properties	isRef 0 minOcc 0 maxOcc 1 content simple
source	<code><xs:element name="cfCopyright" type="xs:string" minOccurs="0"/></code>

element **cfOrgUnit_ResPubl__Type/cfOrder**

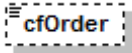
diagram	
namespace	urn:xmlns:org:eurocris:cerif-1.6-2
type	xs:int
properties	isRef 0 minOcc 0 maxOcc 1 content simple
source	<code><xs:element name="cfOrder" type="xs:int" minOccurs="0"/></code>

complexType **cfOrgUnitKeyw__Type**

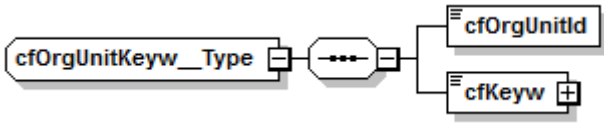
diagram	
namespace	urn:xmlns:org:eurocris:cerif-1.6-2
children	cfOrgUnitId cfKeyw
used by	element CERIF/cfOrgUnitKeyw
source	<pre><xs:complexType name="cfOrgUnitKeyw__Type"> <xs:sequence> <xs:element name="cfOrgUnitId" type="cfd__Type"/> <xs:element name="cfKeyw" type="cfMLangString__Type"/> </xs:sequence> </xs:complexType></pre>

element **cfOrgUnitKeyw__Type/cfOrgUnitId**

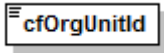
diagram	
namespace	urn.xmlns:org:eurocris:cerif-1.6-2
type	cfId_Type
properties	isRef 0 content simple
facets	Kind Value annotation maxLength 128
source	<code><xs:element name="cfOrgUnitId" type="cfId__Type"/></code>

element **cfOrgUnitKeyw__Type/cfKeyw**

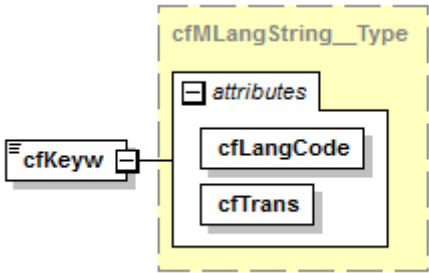
diagram																			
namespace	urn.xmlns:org:eurocris:cerif-1.6-2																		
type	cfMLangString_Type																		
properties	isRef 0 content complex																		
attributes	<table border="1"> <thead> <tr> <th>Name</th> <th>Type</th> <th>Use</th> <th>Default</th> <th>Fixed</th> <th>annotation</th> </tr> </thead> <tbody> <tr> <td>cfLangCode</td> <td>xs:string</td> <td>required</td> <td></td> <td></td> <td></td> </tr> <tr> <td>cfTrans</td> <td>cfTrans_Type</td> <td>required</td> <td></td> <td></td> <td></td> </tr> </tbody> </table>	Name	Type	Use	Default	Fixed	annotation	cfLangCode	xs:string	required				cfTrans	cfTrans_Type	required			
Name	Type	Use	Default	Fixed	annotation														
cfLangCode	xs:string	required																	
cfTrans	cfTrans_Type	required																	
source	<code><xs:element name="cfKeyw" type="cfMLangString__Type"/></code>																		

complexType **cfOrgUnitName__Type**

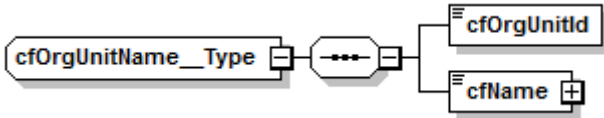
diagram	
namespace	urn.xmlns:org:eurocris:cerif-1.6-2
children	cfOrgUnitId cfName
used by	element CERIF/cfOrgUnitName
source	<code><xs:complexType name="cfOrgUnitName__Type"> <xs:sequence> <xs:element name="cfOrgUnitId" type="cfId__Type"/> <xs:element name="cfName" type="cfMLangString__Type"/> </xs:sequence> </xs:complexType></code>

element **cfOrgUnitName__Type/cfOrgUnitId**

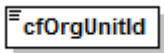
diagram	
namespace	urn.xmlns:org:eurocris:cerif-1.6-2
type	cfId_Type

properties	isRef 0 content simple
facets	Kind Value annotation maxLength 128
source	<code><xs:element name="cfOrgUnitId" type="cfId__Type"/></code>

element cfOrgUnitName__Type/cfName

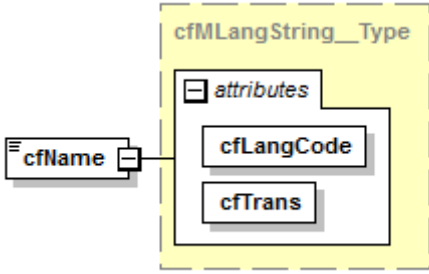
diagram																			
namespace	urn:xmlns:org:eurocris:cerif-1.6-2																		
type	cfMLangString__Type																		
properties	isRef 0 content complex																		
attributes	<table border="1"> <thead> <tr> <th>Name</th> <th>Type</th> <th>Use</th> <th>Default</th> <th>Fixed</th> <th>annotation</th> </tr> </thead> <tbody> <tr> <td>cfLangCode</td> <td>xs:string</td> <td>required</td> <td></td> <td></td> <td></td> </tr> <tr> <td>cfTrans</td> <td>cfTrans__Type</td> <td>required</td> <td></td> <td></td> <td></td> </tr> </tbody> </table>	Name	Type	Use	Default	Fixed	annotation	cfLangCode	xs:string	required				cfTrans	cfTrans__Type	required			
Name	Type	Use	Default	Fixed	annotation														
cfLangCode	xs:string	required																	
cfTrans	cfTrans__Type	required																	
source	<code><xs:element name="cfName" type="cfMLangString__Type"/></code>																		

complexType cfOrgUnitResAct__Type

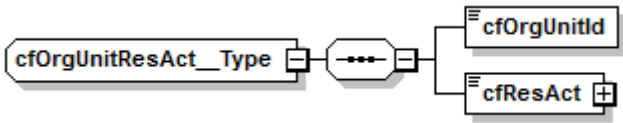
diagram	
namespace	urn:xmlns:org:eurocris:cerif-1.6-2
children	cfOrgUnitId cfResAct
used by	element CERIF/cfOrgUnitResAct
source	<pre> <xs:complexType name="cfOrgUnitResAct__Type"> <xs:sequence> <xs:element name="cfOrgUnitId" type="cfId__Type"/> <xs:element name="cfResAct" type="cfMLangString__Type"/> </xs:sequence> </xs:complexType> </pre>

element cfOrgUnitResAct__Type/cfOrgUnitId

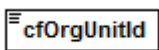
diagram	
namespace	urn:xmlns:org:eurocris:cerif-1.6-2
type	cfId__Type
properties	isRef 0 content simple
facets	Kind Value annotation maxLength 128
source	<code><xs:element name="cfOrgUnitId" type="cfId__Type"/></code>

element **cfOrgUnitResAct__Type/cfResAct**

diagram						
namespace	urn.xmlns:org:eurocris:cerif-1.6-2					
type	cfMLangString__Type					
properties	isRef	0	content	complex		
attributes	Name	Type	Use	Default	Fixed	annotation
	cfLangCode	xs:string	required			
	cfTrans	cfTrans__Type	required			
source	<code><xs:element name="cfResAct" type="cfMLangString__Type"/></code>					

complexType **cfPAddr__Type**

diagram						
namespace	urn.xmlns:org:eurocris:cerif-1.6-2					
children	cfPAddrId cfCountryCode cfAddrline1 cfAddrline2 cfAddrline3 cfAddrline4 cfAddrline5 cfPostCode cfCityTown cfStateOfCountry cfURI cfOrgUnit_PAddr cfPers_PAddr cfPAddr_Class cfFedId					
used by	element	CERIF/cfPAddr				

source	<pre> <xs:complexType name="cfPAddr__Type"> <xs:sequence> <xs:element name="cfPAddrId" type="cfld__Type"/> <xs:element name="cfCountryCode" type="xs:string" minOccurs="0"/> <xs:element name="cfAddrline1" type="xs:string" minOccurs="0"/> <xs:element name="cfAddrline2" type="xs:string" minOccurs="0"/> <xs:element name="cfAddrline3" type="xs:string" minOccurs="0"/> <xs:element name="cfAddrline4" type="xs:string" minOccurs="0"/> <xs:element name="cfAddrline5" type="xs:string" minOccurs="0"/> <xs:element name="cfPostCode" type="xs:string" minOccurs="0"/> <xs:element name="cfCityTown" type="xs:string" minOccurs="0"/> <xs:element name="cfStateOfCountry" type="xs:string" minOccurs="0"/> <xs:element name="cfURI" type="xs:string" minOccurs="0"/> <xs:choice minOccurs="0" maxOccurs="unbounded"> <!-- embedded linking entities --> <xs:element name="cfOrgUnit_PAddr"> <xs:complexType> <xs:sequence> <xs:element name="cfOrgUnitId" type="cfld__Type"/> <xs:group ref="cfCoreClassWithFraction__Group"/> </xs:sequence> </xs:complexType> </xs:element> <xs:element name="cfPers_PAddr"> <xs:complexType> <xs:sequence> <xs:element name="cfPersId" type="cfld__Type"/> <xs:group ref="cfCoreClassWithFraction__Group"/> </xs:sequence> </xs:complexType> </xs:element> <xs:element name="cfPAddr_Class" type="cfCoreClassWithFraction__Type"/> <!-- embedded federated identifiers --> <xs:element name="cfFedId" type="cfFedId__EmbType"/> </xs:choice> </xs:sequence> </xs:complexType> </pre>
--------	--

element cfPAddr__Type/cfPAddrId

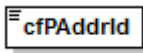
diagram	
namespace	urn:xmlns:org:eurocris:cerif-1.6-2
type	cfld__Type
properties	isRef 0 content simple
facets	Kind Value annotation maxLength 128
source	<pre><xs:element name="cfPAddrId" type="cfld__Type"/></pre>

element cfPAddr__Type/cfCountryCode

diagram	
namespace	urn:xmlns:org:eurocris:cerif-1.6-2
type	xs:string
properties	isRef 0 minOcc 0 maxOcc 1

	content simple
source	<code><xs:element name="cfCountryCode" type="xs:string" minOccurs="0"/></code>

element **cfPAddr_Type/cfAddrline1**

diagram	
namespace	urn:xmlns:org:eurocris:cerif-1.6-2
type	xs:string
properties	isRef 0 minOcc 0 maxOcc 1 content simple
source	<code><xs:element name="cfAddrline1" type="xs:string" minOccurs="0"/></code>

element **cfPAddr_Type/cfAddrline2**

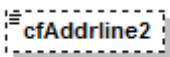
diagram	
namespace	urn:xmlns:org:eurocris:cerif-1.6-2
type	xs:string
properties	isRef 0 minOcc 0 maxOcc 1 content simple
source	<code><xs:element name="cfAddrline2" type="xs:string" minOccurs="0"/></code>

element **cfPAddr_Type/cfAddrline3**

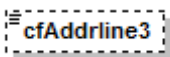
diagram	
namespace	urn:xmlns:org:eurocris:cerif-1.6-2
type	xs:string
properties	isRef 0 minOcc 0 maxOcc 1 content simple
source	<code><xs:element name="cfAddrline3" type="xs:string" minOccurs="0"/></code>

element **cfPAddr_Type/cfAddrline4**

diagram	
namespace	urn:xmlns:org:eurocris:cerif-1.6-2
type	xs:string
properties	isRef 0 minOcc 0 maxOcc 1 content simple
source	<code><xs:element name="cfAddrline4" type="xs:string" minOccurs="0"/></code>

element **cfPAddr_Type/cfAddrline5**

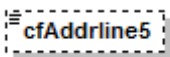
diagram	
namespace	urn:xmlns:org:eurocris:cerif-1.6-2

type	xs:string
properties	isRef 0 minOcc 0 maxOcc 1 content simple
source	<code><xs:element name="cfAddrline5" type="xs:string" minOccurs="0"/></code>

element cfPAddr_Type/cfPostCode

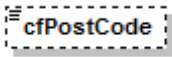
diagram	
namespace	urn:xmlns:org:eurocris:cerif-1.6-2
type	xs:string
properties	isRef 0 minOcc 0 maxOcc 1 content simple
source	<code><xs:element name="cfPostCode" type="xs:string" minOccurs="0"/></code>

element cfPAddr_Type/cfCityTown

diagram	
namespace	urn:xmlns:org:eurocris:cerif-1.6-2
type	xs:string
properties	isRef 0 minOcc 0 maxOcc 1 content simple
source	<code><xs:element name="cfCityTown" type="xs:string" minOccurs="0"/></code>

element cfPAddr_Type/cfStateOfCountry

diagram	
namespace	urn:xmlns:org:eurocris:cerif-1.6-2
type	xs:string
properties	isRef 0 minOcc 0 maxOcc 1 content simple
source	<code><xs:element name="cfStateOfCountry" type="xs:string" minOccurs="0"/></code>

element cfPAddr_Type/cfURI

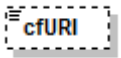
diagram	
namespace	urn:xmlns:org:eurocris:cerif-1.6-2
type	xs:string
properties	isRef 0 minOcc 0 maxOcc 1 content simple
source	<code><xs:element name="cfURI" type="xs:string" minOccurs="0"/></code>

element **cfPAddr_Type/cfOrgUnit_PAddr**

diagram	
namespace	urn:xmlns:org:eurocris:cerif-1.6-2
properties	isRef 0 content complex
children	cfOrgUnitId cfClassId cfClassSchemeld cfStartDate cfEndDate cfFraction
source	<pre><xs:element name="cfOrgUnit_PAddr"> <xs:complexType> <xs:sequence> <xs:element name="cfOrgUnitId" type="cfId__Type"/> <xs:group ref="cfCoreClassWithFraction__Group"/> </xs:sequence> </xs:complexType> </xs:element></pre>

element **cfPAddr_Type/cfOrgUnit_PAddr/cfOrgUnitId**

diagram	
namespace	urn:xmlns:org:eurocris:cerif-1.6-2
type	cfId__Type
properties	isRef 0 content simple
facets	Kind Value annotation maxLength 128
source	<pre><xs:element name="cfOrgUnitId" type="cfId__Type"/></pre>

element **cfPAddr_Type/cfPers_PAddr**

diagram	
namespace	urn:xmlns:org:eurocris:cerif-1.6-2
properties	isRef 0 content complex
children	cfPersId cfClassId cfClassSchemeld cfStartDate cfEndDate cfFraction
source	<pre><xs:element name="cfPers_PAddr"> <xs:complexType> <xs:sequence> <xs:element name="cfPersId" type="cfId__Type"/> <xs:group ref="cfCoreClassWithFraction__Group"/> </xs:sequence> </xs:complexType> </xs:element></pre>

	<pre></xs:complexType> </xs:element></pre>
--	--

element **cfPAddr__Type/cfPers_PAddr/cfPersId**

diagram	
namespace	urn:xmlns:org:eurocris:cerif-1.6-2
type	cfdl_Type
properties	isRef 0 content simple
facets	Kind Value annotation maxLength 128
source	<code><xs:element name="cfPersId" type="cfdl_Type"/></code>

element **cfPAddr__Type/cfPAddr_Class**

diagram	
namespace	urn:xmlns:org:eurocris:cerif-1.6-2
type	cfCoreClassWithFraction_Type
properties	isRef 0 content complex
children	cfClassId cfClassSchemeld cfStartDate cfEndDate cfFraction
source	<code><xs:element name="cfPAddr_Class" type="cfCoreClassWithFraction_Type"/></code>

element **cfPAddr__Type/cfFedId**

diagram	
namespace	urn:xmlns:org:eurocris:cerif-1.6-2
type	cfFedId_EmbType

properties	isRef 0 content complex
children	cfFedIdId cfFedId cfClassId cfClassSchemeId cfStartDate cfEndDate cfFedId_Class
source	<code><xs:element name="cfFedId" type="cfFedId__EmbType"/></code>

complexType **cfPAddr_Class_Type**

diagram	
namespace	urn.xmlns:org:eurocris:cerif-1.6-2
children	cfPAddrId cfClassId cfClassSchemeId cfStartDate cfEndDate cfFraction
used by	element CERIF/cfPAddr_Class
source	<pre> <xs:complexType name="cfPAddr_Class_Type"> <xs:sequence> <xs:element name="cfPAddrId" type="cflD__Type"/> <xs:group ref="cfCoreClassWithFraction_Group"/> </xs:sequence> </xs:complexType> </pre>

element **cfPAddr_Class_Type/cfPAddrId**

diagram	
namespace	urn.xmlns:org:eurocris:cerif-1.6-2
type	cflD_Type
properties	isRef 0 content simple
facets	Kind Value annotation maxLength 128
source	<code><xs:element name="cfPAddrId" type="cflD__Type"/></code>

complexType cfPers__Type

<p>diagram</p>	
<p>namespace</p>	<p>urn:xmlns:org:eurocris:cerif-1.6-2</p>
<p>children</p>	<p>cfPersId cfBirthdate cfGender cfURI cfResInt cfKeyw cfPers_Pers cfPers_EAddr cfPers_Class cfPers_CV cfPers_Event cfPers_Fund cfPers_Lang cfPers_Country cfPers_OrgUnit cfPers_ResPubl cfProj_Pers cfPers_PAddr cfPers_DC cfPers_Qual cfPersName_Pers cfPers_Meas cfPers_Indic cfFedId</p>
<p>used by</p>	<p>element CERIF/cfPers</p>
<p>source</p>	<pre><xs:complexType name="cfPers__Type"> <xs:sequence></pre>

```

<xs:element name="cfPersId" type="cfId__Type"/>
<xs:element name="cfBirthdate" type="xs:date" minOccurs="0"/>
<xs:element name="cfGender" type="cfGender__Type" minOccurs="0"/>
<xs:element name="cfURI" type="xs:string" minOccurs="0"/>
<xs:choice minOccurs="0" maxOccurs="unbounded">
  <!-- embedded multiple-language attributes -->
  <xs:element name="cfResInt" type="cfMLangString__Type"/>
  <xs:element name="cfKeyw" type="cfMLangString__Type"/>
  <!-- embedded linking entities -->
  <xs:element name="cfPers_Pers">
    <xs:complexType>
      <xs:sequence>
        <xs:choice>
          <xs:element name="cfPersId2" type="cfId__Type"/>
          <xs:element name="cfPersId1" type="cfId__Type"/>
        </xs:choice>
        <xs:group ref="cfCoreClassWithFraction__Group"/>
      </xs:sequence>
    </xs:complexType>
  </xs:element>
  <xs:element name="cfPers_EAddr">
    <xs:complexType>
      <xs:sequence>
        <xs:element name="cfEAddrId" type="cfId__Type"/>
        <xs:group ref="cfCoreClassWithFraction__Group"/>
      </xs:sequence>
    </xs:complexType>
  </xs:element>
  <xs:element name="cfPers_Class" type="cfCoreClassWithFraction__Type"/>
  <xs:element name="cfPers_CV">
    <xs:complexType>
      <xs:sequence>
        <xs:element name="cfCVId" type="cfId__Type"/>
        <xs:group ref="cfCoreClassWithFraction__Group"/>
      </xs:sequence>
    </xs:complexType>
  </xs:element>
  <xs:element name="cfPers_Event">
    <xs:complexType>
      <xs:sequence>
        <xs:element name="cfEventId" type="cfId__Type"/>
        <xs:group ref="cfCoreClassWithFraction__Group"/>
      </xs:sequence>
    </xs:complexType>
  </xs:element>
  <xs:element name="cfPers_Fund">
    <xs:complexType>
      <xs:sequence>
        <xs:element name="cfFundId" type="cfId__Type"/>
        <xs:group ref="cfCoreClassWithFraction__Group"/>
        <xs:element name="cfAmount" type="cfAmount__Type" minOccurs="0"/>
      </xs:sequence>
    </xs:complexType>
  </xs:element>
  <xs:element name="cfPers_Lang">
    <xs:complexType>
      <xs:sequence>
        <xs:element name="cfLangCode" type="xs:string"/>
        <xs:group ref="cfCoreClassWithFraction__Group"/>
        <xs:element name="cfSkillReading" type="xs:string" minOccurs="0"/>
        <xs:element name="cfSkillSpeaking" type="xs:string" minOccurs="0"/>
        <xs:element name="cfSkillWriting" type="xs:string" minOccurs="0"/>

```

```

</xs:sequence>
</xs:complexType>
</xs:element>
<xs:element name="cfPers_Country">
  <xs:complexType>
    <xs:sequence>
      <xs:element name="cfCountryCode" type="xs:string"/>
      <xs:group ref="cfCoreClassWithFraction__Group"/>
    </xs:sequence>
  </xs:complexType>
</xs:element>
<xs:element name="cfPers_OrgUnit">
  <xs:complexType>
    <xs:sequence>
      <xs:element name="cfOrgUnitId" type="cflD__Type"/>
      <xs:group ref="cfCoreClassWithFraction__Group"/>
    </xs:sequence>
  </xs:complexType>
</xs:element>
<xs:element name="cfPers_ResPubl">
  <xs:complexType>
    <xs:sequence>
      <xs:element name="cfResPublId" type="cflD__Type"/>
      <xs:group ref="cfCoreClassWithFraction__Group"/>
      <xs:element name="cfCopyright" type="xs:string" minOccurs="0"/>
      <xs:element name="cfOrder" type="xs:int" minOccurs="0"/>
    </xs:sequence>
  </xs:complexType>
</xs:element>
<xs:element name="cfProj_Pers">
  <xs:complexType>
    <xs:sequence>
      <xs:element name="cfProjId" type="cflD__Type"/>
      <xs:group ref="cfCoreClassWithFraction__Group"/>
    </xs:sequence>
  </xs:complexType>
</xs:element>
<xs:element name="cfPers_PAddr">
  <xs:complexType>
    <xs:sequence>
      <xs:element name="cfPAddrId" type="cflD__Type"/>
      <xs:group ref="cfCoreClassWithFraction__Group"/>
    </xs:sequence>
  </xs:complexType>
</xs:element>
<xs:element name="cfPers_DC">
  <xs:complexType>
    <xs:sequence>
      <xs:sequence>
        <xs:element name="cfDCId" type="xs:string"/>
        <xs:element name="cfDCScheme" type="xs:string"/>
      </xs:sequence>
      <xs:group ref="cfCoreClassWithFraction__Group"/>
    </xs:sequence>
  </xs:complexType>
</xs:element>
<xs:element name="cfPers_Qual">
  <xs:complexType>
    <xs:sequence>
      <xs:element name="cfQualId" type="cflD__Type"/>
      <xs:group ref="cfCoreClassWithFraction__Group"/>
    </xs:sequence>
  </xs:complexType>
</xs:element>

```

```

</xs:complexType>
</xs:element>
<xs:element name="cfPersName_Pers">
  <xs:complexType>
    <xs:sequence>
      <xs:element name="cfPersNameId" type="cfld__Type"/>
      <xs:group ref="cfCoreClass__Group"/>
      <xs:element name="cfFamilyNames" type="xs:string" minOccurs="0"/>
      <xs:element name="cfFirstNames" type="xs:string" minOccurs="0"/>
      <xs:element name="cfOtherNames" type="xs:string" minOccurs="0"/>
    </xs:sequence>
  </xs:complexType>
</xs:element>
<xs:element name="cfPers_Meas">
  <xs:complexType>
    <xs:sequence>
      <xs:element name="cfMeasId" type="cfld__Type"/>
      <xs:group ref="cfCoreClassWithFraction__Group"/>
    </xs:sequence>
  </xs:complexType>
</xs:element>
<xs:element name="cfPers_Indic">
  <xs:complexType>
    <xs:sequence>
      <xs:element name="cfIndicId" type="cfld__Type"/>
      <xs:group ref="cfCoreClassWithFraction__Group"/>
    </xs:sequence>
  </xs:complexType>
</xs:element>
<!-- embedded federated identifiers -->
<xs:element name="cfFedId" type="cfFedId__EmbType"/>
</xs:choice>
</xs:sequence>
</xs:complexType>
    
```

element cfPers__Type/cfPersId

diagram	
namespace	urn:xmlns:org:eurocris:cerif-1.6-2
type	cfld__Type
properties	isRef 0 content simple
facets	Kind Value annotation maxLength 128
source	<xs:element name="cfPersId" type="cfld__Type"/>

element cfPers__Type/cfBirthdate

diagram	
namespace	urn:xmlns:org:eurocris:cerif-1.6-2
type	xs:date
properties	isRef 0 minOcc 0 maxOcc 1 content simple
source	<xs:element name="cfBirthdate" type="xs:date" minOccurs="0"/>

element **cfPers__Type/cfGender**

diagram													
namespace	urn:xmlns:org:eurocris:cerif-1.6-2												
type	cfGender__Type												
properties	isRef 0 minOcc 0 maxOcc 1 content simple												
facets	<table border="1"> <thead> <tr> <th>Kind</th> <th>Value</th> <th>annotation</th> </tr> </thead> <tbody> <tr> <td>enumeration</td> <td>m</td> <td>documentation Male</td> </tr> <tr> <td>enumeration</td> <td>f</td> <td>documentation Female</td> </tr> <tr> <td>enumeration</td> <td>u</td> <td>documentation Unknown</td> </tr> </tbody> </table>	Kind	Value	annotation	enumeration	m	documentation Male	enumeration	f	documentation Female	enumeration	u	documentation Unknown
Kind	Value	annotation											
enumeration	m	documentation Male											
enumeration	f	documentation Female											
enumeration	u	documentation Unknown											
source	<code><xs:element name="cfGender" type="cfGender__Type" minOccurs="0"/></code>												

element **cfPers__Type/cfURI**

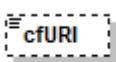
diagram	
namespace	urn:xmlns:org:eurocris:cerif-1.6-2
type	xs:string
properties	isRef 0 minOcc 0 maxOcc 1 content simple
source	<code><xs:element name="cfURI" type="xs:string" minOccurs="0"/></code>

element **cfPers__Type/cfResInt**

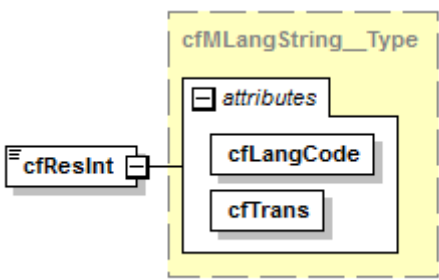
diagram																			
namespace	urn:xmlns:org:eurocris:cerif-1.6-2																		
type	cfMLangString__Type																		
properties	isRef 0 content complex																		
attributes	<table border="1"> <thead> <tr> <th>Name</th> <th>Type</th> <th>Use</th> <th>Default</th> <th>Fixed</th> <th>annotation</th> </tr> </thead> <tbody> <tr> <td>cfLangCode</td> <td>xs:string</td> <td>required</td> <td></td> <td></td> <td></td> </tr> <tr> <td>cfTrans</td> <td>cfTrans__Type</td> <td>required</td> <td></td> <td></td> <td></td> </tr> </tbody> </table>	Name	Type	Use	Default	Fixed	annotation	cfLangCode	xs:string	required				cfTrans	cfTrans__Type	required			
Name	Type	Use	Default	Fixed	annotation														
cfLangCode	xs:string	required																	
cfTrans	cfTrans__Type	required																	
source	<code><xs:element name="cfResInt" type="cfMLangString__Type"/></code>																		

element **cfPers__Type/cfKeyw**

diagram																			
namespace	urn:xmlns:org:eurocris:cerif-1.6-2																		
type	cfMLangString__Type																		
properties	isRef 0 content complex																		
attributes	<table border="1"> <thead> <tr> <th>Name</th> <th>Type</th> <th>Use</th> <th>Default</th> <th>Fixed</th> <th>annotation</th> </tr> </thead> <tbody> <tr> <td>cfLangCode</td> <td>xs:string</td> <td>required</td> <td></td> <td></td> <td></td> </tr> <tr> <td>cfTrans</td> <td>cfTrans__Type</td> <td>required</td> <td></td> <td></td> <td></td> </tr> </tbody> </table>	Name	Type	Use	Default	Fixed	annotation	cfLangCode	xs:string	required				cfTrans	cfTrans__Type	required			
Name	Type	Use	Default	Fixed	annotation														
cfLangCode	xs:string	required																	
cfTrans	cfTrans__Type	required																	
source	<code><xs:element name="cfKeyw" type="cfMLangString__Type"/></code>																		

element **cfPers__Type/cfPers_Pers**

diagram	
namespace	urn:xmlns:org:eurocris:cerif-1.6-2
properties	isRef 0 content complex
children	cfPersId2 cfPersId1 cfClassId cfClassSchemeId cfStartDate cfEndDate cfFraction
source	<pre> <xs:element name="cfPers_Pers"> <xs:complexType> <xs:sequence> <xs:choice> <xs:element name="cfPersId2" type="cfld__Type"/> <xs:element name="cfPersId1" type="cfld__Type"/> </xs:choice> <xs:group ref="cfCoreClassWithFraction__Group"/> </xs:sequence> </xs:complexType> </xs:element> </pre>

element **cfPers__Type/cfPers_Pers/cfPersId2**

diagram	
namespace	urn:xmlns:org:eurocris:cerif-1.6-2
type	cfld__Type
properties	isRef 0

	content simple
facets	Kind Value annotation maxLength 128
source	<xs:element name="cfPersId2" type="cfdl__Type"/>

element cfPers__Type/cfPers_Pers/cfPersId1

diagram	
namespace	urn:xmlns:org:eurocris:cerif-1.6-2
type	cfdl__Type
properties	isRef 0 content simple
facets	Kind Value annotation maxLength 128
source	<xs:element name="cfPersId1" type="cfdl__Type"/>

element cfPers__Type/cfPers_EAddr

diagram	
namespace	urn:xmlns:org:eurocris:cerif-1.6-2
properties	isRef 0 content complex
children	cfEAddrId cfClassId cfClassSchemeId cfStartDate cfEndDate cfFraction
source	<xs:element name="cfPers_EAddr"> <xs:complexType> <xs:sequence> <xs:element name="cfEAddrId" type="cfdl__Type"/> <xs:group ref="cfCoreClassWithFraction__Group"/> </xs:sequence> </xs:complexType> </xs:element>

element cfPers__Type/cfPers_EAddr/cfEAddrId

diagram	
namespace	urn:xmlns:org:eurocris:cerif-1.6-2
type	cfdl__Type
properties	isRef 0 content simple
facets	Kind Value annotation maxLength 128
source	<xs:element name="cfEAddrId" type="cfdl__Type"/>

element cfPers__Type/cfPers_Class

diagram	
namespace	urn:xmlns:org:eurocris:cerif-1.6-2
type	cfCoreClassWithFraction__Type
properties	isRef 0 content complex
children	cfClassId cfClassSchemeld cfStartDate cfEndDate cfFraction
source	<code><xs:element name="cfPers_Class" type="cfCoreClassWithFraction__Type"/></code>

element cfPers__Type/cfPers_CV

diagram	
namespace	urn:xmlns:org:eurocris:cerif-1.6-2
properties	isRef 0 content complex
children	cfCVId cfClassId cfClassSchemeld cfStartDate cfEndDate cfFraction
source	<pre> <xs:element name="cfPers_CV"> <xs:complexType> <xs:sequence> <xs:element name="cfCVId" type="cflD__Type"/> <xs:group ref="cfCoreClassWithFraction__Group"/> </xs:sequence> </xs:complexType> </xs:element> </pre>

element cfPers__Type/cfPers_CV/cfCVId

diagram	
namespace	urn:xmlns:org:eurocris:cerif-1.6-2
type	cflD__Type
properties	isRef 0 content simple
facets	Kind Value annotation maxLength 128
source	<code><xs:element name="cfCVId" type="cflD__Type"/></code>

element cfPers__Type/cfPers_Event

diagram	
namespace	urn:xmlns:org:eurocris:cerif-1.6-2
properties	isRef 0 content complex
children	cfEventId cfClassId cfClassSchemeld cfStartDate cfEndDate cfFraction
source	<pre><xs:element name="cfPers_Event"> <xs:complexType> <xs:sequence> <xs:element name="cfEventId" type="cfd__Type"/> <xs:group ref="cfCoreClassWithFraction__Group"/> </xs:sequence> </xs:complexType> </xs:element></pre>

element cfPers__Type/cfPers_Event/cfEventId

diagram	
namespace	urn:xmlns:org:eurocris:cerif-1.6-2
type	cfd__Type
properties	isRef 0 content simple
facets	Kind Value annotation maxLength 128
source	<pre><xs:element name="cfEventId" type="cfd__Type"/></pre>

element cfPers__Type/cfPers_Fund

diagram	
namespace	urn:xmlns:org:eurocris:cerif-1.6-2
properties	isRef 0 content complex
children	cfFundId cfClassId cfClassSchemeld cfStartDate cfEndDate cfFraction cfAmount
source	<pre><xs:element name="cfPers_Fund"> <xs:complexType> <xs:sequence> <xs:element name="cfFundId" type="cfd__Type"/> </xs:sequence> </xs:complexType> </xs:element></pre>

	<pre> <xs:group ref="cfCoreClassWithFraction__Group"/> <xs:element name="cfAmount" type="cfAmount__Type" minOccurs="0"/> </xs:sequence> </xs:complexType> </xs:element> </pre>
--	--

element cfPers__Type/cfPers_Fund/cfFundId

diagram	
namespace	urn:xmlns:org:eurocris:cerif-1.6-2
type	cfId__Type
properties	isRef 0 content simple
facets	Kind Value annotation maxLength 128
source	<code><xs:element name="cfFundId" type="cfId__Type"/></code>

element cfPers__Type/cfPers_Fund/cfAmount

diagram													
namespace	urn:xmlns:org:eurocris:cerif-1.6-2												
type	cfAmount__Type												
properties	isRef 0 minOcc 0 maxOcc 1 content complex												
attributes	<table border="1"> <thead> <tr> <th>Name</th> <th>Type</th> <th>Use</th> <th>Default</th> <th>Fixed</th> <th>annotation</th> </tr> </thead> <tbody> <tr> <td>cfCurrCode</td> <td>xs:string</td> <td>required</td> <td></td> <td></td> <td></td> </tr> </tbody> </table>	Name	Type	Use	Default	Fixed	annotation	cfCurrCode	xs:string	required			
Name	Type	Use	Default	Fixed	annotation								
cfCurrCode	xs:string	required											
source	<code><xs:element name="cfAmount" type="cfAmount__Type" minOccurs="0"/></code>												

element cfPers__Type/cfPers_Lang

diagram	
namespace	urn:xmlns:org:eurocris:cerif-1.6-2
properties	isRef 0 content complex
children	cfLangCode cfClassId cfClassSchemeld cfStartDate cfEndDate cfFraction cfSkillReading cfSkillSpeaking

	cfSkillWriting
source	<pre><xs:element name="cfPers_Lang"> <xs:complexType> <xs:sequence> <xs:element name="cfLangCode" type="xs:string"/> <xs:group ref="cfCoreClassWithFraction_Group"/> <xs:element name="cfSkillReading" type="xs:string" minOccurs="0"/> <xs:element name="cfSkillSpeaking" type="xs:string" minOccurs="0"/> <xs:element name="cfSkillWriting" type="xs:string" minOccurs="0"/> </xs:sequence> </xs:complexType> </xs:element></pre>

element cfPers__Type/cfPers_Lang/cfLangCode

diagram	
namespace	urn:xmlns:org:eurocris:cerif-1.6-2
type	xs:string
properties	isRef 0 content simple
source	<pre><xs:element name="cfLangCode" type="xs:string"/></pre>

element cfPers__Type/cfPers_Lang/cfSkillReading

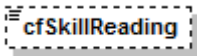
diagram	
namespace	urn:xmlns:org:eurocris:cerif-1.6-2
type	xs:string
properties	isRef 0 minOcc 0 maxOcc 1 content simple
source	<pre><xs:element name="cfSkillReading" type="xs:string" minOccurs="0"/></pre>

element cfPers__Type/cfPers_Lang/cfSkillSpeaking

diagram	
namespace	urn:xmlns:org:eurocris:cerif-1.6-2
type	xs:string
properties	isRef 0 minOcc 0 maxOcc 1 content simple
source	<pre><xs:element name="cfSkillSpeaking" type="xs:string" minOccurs="0"/></pre>

element cfPers__Type/cfPers_Lang/cfSkillWriting

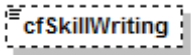
diagram	
namespace	urn:xmlns:org:eurocris:cerif-1.6-2
type	xs:string
properties	isRef 0 minOcc 0 maxOcc 1 content simple

source	<code><xs:element name="cfSkillWriting" type="xs:string" minOccurs="0"/></code>
--------	---

element **cfPers__Type/cfPers_Country**

diagram	
namespace	urn:xmlns:org:eurocris:cerif-1.6-2
properties	isRef 0 content complex
children	cfCountryCode cfClassId cfClassSchemeld cfStartDate cfEndDate cfFraction
source	<pre><xs:element name="cfPers_Country"> <xs:complexType> <xs:sequence> <xs:element name="cfCountryCode" type="xs:string"/> <xs:group ref="cfCoreClassWithFraction__Group"/> </xs:sequence> </xs:complexType> </xs:element></pre>

element **cfPers__Type/cfPers_Country/cfCountryCode**

diagram	
namespace	urn:xmlns:org:eurocris:cerif-1.6-2
type	xs:string
properties	isRef 0 content simple
source	<code><xs:element name="cfCountryCode" type="xs:string"/></code>

element **cfPers__Type/cfPers_OrgUnit**

diagram	
namespace	urn:xmlns:org:eurocris:cerif-1.6-2
properties	isRef 0 content complex
children	cfOrgUnitId cfClassId cfClassSchemeld cfStartDate cfEndDate cfFraction
source	<pre><xs:element name="cfPers_OrgUnit"> <xs:complexType> <xs:sequence> <xs:element name="cfOrgUnitId" type="cflD__Type"/> <xs:group ref="cfCoreClassWithFraction__Group"/> </xs:sequence> </xs:complexType> </xs:element></pre>

	<pre></xs:complexType> </xs:element></pre>
--	--

element cfPers__Type/cfPers_OrgUnit/cfOrgUnitId

diagram	
namespace	urn:xmlns:org:eurocris:cerif-1.6-2
type	cflD_Type
properties	isRef 0 content simple
facets	Kind Value annotation maxLength 128
source	<pre><xs:element name="cfOrgUnitId" type="cflD__Type"/></pre>

element cfPers__Type/cfPers_ResPubl

diagram	
namespace	urn:xmlns:org:eurocris:cerif-1.6-2
properties	isRef 0 content complex
children	cfResPublId cfClassId cfClassSchemeld cfStartDate cfEndDate cfFraction cfCopyright cfOrder
source	<pre><xs:element name="cfPers_ResPubl"> <xs:complexType> <xs:sequence> <xs:element name="cfResPublId" type="cflD__Type"/> <xs:group ref="cfCoreClassWithFraction_Group"/> <xs:element name="cfCopyright" type="xs:string" minOccurs="0"/> <xs:element name="cfOrder" type="xs:int" minOccurs="0"/> </xs:sequence> </xs:complexType> </xs:element></pre>

element cfPers__Type/cfPers_ResPubl/cfResPublId

diagram	
namespace	urn:xmlns:org:eurocris:cerif-1.6-2
type	cflD_Type
properties	isRef 0 content simple
facets	Kind Value annotation maxLength 128
source	<pre><xs:element name="cfResPublId" type="cflD__Type"/></pre>

element **cfPers_Type/cfPers_ResPubl/cfCopyright**

diagram	
namespace	urn:xmlns:org:eurocris:cerif-1.6-2
type	xs:string
properties	isRef 0 minOcc 0 maxOcc 1 content simple
source	<code><xs:element name="cfCopyright" type="xs:string" minOccurs="0"/></code>

element **cfPers_Type/cfPers_ResPubl/cfOrder**

diagram	
namespace	urn:xmlns:org:eurocris:cerif-1.6-2
type	xs:int
properties	isRef 0 minOcc 0 maxOcc 1 content simple
source	<code><xs:element name="cfOrder" type="xs:int" minOccurs="0"/></code>

element **cfPers_Type/cfProj_Pers**

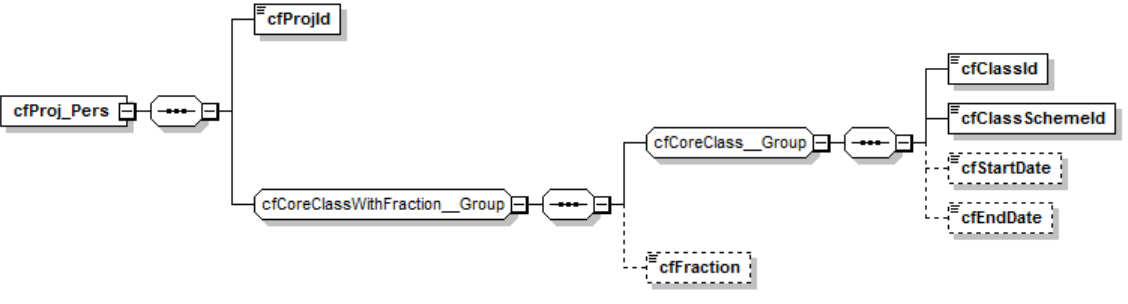
diagram	
namespace	urn:xmlns:org:eurocris:cerif-1.6-2
properties	isRef 0 content complex
children	cfProjId cfClassId cfClassSchemeld cfStartDate cfEndDate cfFraction
source	<pre><xs:element name="cfProj_Pers"> <xs:complexType> <xs:sequence> <xs:element name="cfProjId" type="cfId_Type"/> <xs:group ref="cfCoreClassWithFraction_Group"/> </xs:sequence> </xs:complexType> </xs:element></pre>

element **cfPers_Type/cfProj_Pers/cfProjId**

diagram	
namespace	urn:xmlns:org:eurocris:cerif-1.6-2
type	cfId_Type
properties	isRef 0 content simple

facets	Kind maxLength	Value 128	annotation
source	<code><xs:element name="cfProjId" type="cflD__Type"/></code>		

element cfPers__Type/cfPers_PAddr

diagram	
namespace	urn:xmlns:org:eurocris:cerif-1.6-2
properties	isRef 0 content complex
children	cfPAddrId cfClassId cfClassSchemeId cfStartDate cfEndDate cfFraction
source	<pre> <xs:element name="cfPers_PAddr"> <xs:complexType> <xs:sequence> <xs:element name="cfPAddrId" type="cflD__Type"/> <xs:group ref="cfCoreClassWithFraction__Group"/> </xs:sequence> </xs:complexType> </xs:element> </pre>

element cfPers__Type/cfPers_PAddr/cfPAddrId

diagram			
namespace	urn:xmlns:org:eurocris:cerif-1.6-2		
type	cflD__Type		
properties	isRef 0 content simple		
facets	Kind maxLength	Value 128	annotation
source	<code><xs:element name="cfPAddrId" type="cflD__Type"/></code>		

element cfPers__Type/cfPers_DC

diagram	
namespace	urn:xmlns:org:eurocris:cerif-1.6-2
properties	isRef 0 content complex
children	cfDCId cfDCScheme cfClassId cfClassSchemeId cfStartDate cfEndDate cfFraction

source	<pre><xs:element name="cfPers_DC"> <xs:complexType> <xs:sequence> <xs:sequence> <xs:element name="cfDCId" type="xs:string"/> <xs:element name="cfDCScheme" type="xs:string"/> </xs:sequence> <xs:group ref="cfCoreClassWithFraction__Group"/> </xs:sequence> </xs:complexType> </xs:element></pre>
--------	--

element cfPers__Type/cfPers_DC/cfDCId

diagram	
namespace	urn:xmlns:org:eurocris:cerif-1.6-2
type	xs:string
properties	isRef 0 content simple
source	<xs:element name="cfDCId" type="xs:string"/>

element cfPers__Type/cfPers_DC/cfDCScheme

diagram	
namespace	urn:xmlns:org:eurocris:cerif-1.6-2
type	xs:string
properties	isRef 0 content simple
source	<xs:element name="cfDCScheme" type="xs:string"/>

element cfPers__Type/cfPers_Qual

diagram	
namespace	urn:xmlns:org:eurocris:cerif-1.6-2
properties	isRef 0 content complex
children	cfQualId cfClassId cfClassSchemeld cfStartDate cfEndDate cfFraction
source	<pre><xs:element name="cfPers_Qual"> <xs:complexType> <xs:sequence> <xs:element name="cfQualId" type="cfId__Type"/> <xs:group ref="cfCoreClassWithFraction__Group"/> </xs:sequence> </xs:complexType> </xs:element></pre>

element **cfPers_Type/cfPers_Qual/cfQualId**

diagram	
namespace	urn:xmlns:org:eurocris:cerif-1.6-2
type	cflD_Type
properties	isRef 0 content simple
facets	Kind Value annotation maxLength 128
source	<code><xs:element name="cfQualId" type="cflD_Type"/></code>

element **cfPers_Type/cfPersName_Pers**

diagram	
namespace	urn:xmlns:org:eurocris:cerif-1.6-2
properties	isRef 0 content complex
children	cfPersNameId cfClassId cfClassSchemeld cfStartDate cfEndDate cfFamilyNames cfFirstNames cfOtherNames
source	<code><xs:element name="cfPersName_Pers"> <xs:complexType> <xs:sequence> <xs:element name="cfPersNameId" type="cflD_Type"/> <xs:group ref="cfCoreClass_Group"/> <xs:element name="cfFamilyNames" type="xs:string" minOccurs="0"/> <xs:element name="cfFirstNames" type="xs:string" minOccurs="0"/> <xs:element name="cfOtherNames" type="xs:string" minOccurs="0"/> </xs:sequence> </xs:complexType> </xs:element></code>

element **cfPers_Type/cfPersName_Pers/cfPersNameId**

diagram	
namespace	urn:xmlns:org:eurocris:cerif-1.6-2
type	cflD_Type
properties	isRef 0 content simple
facets	Kind Value annotation maxLength 128

source	<xs:element name="cfPersNameId" type="cfId__Type"/>
--------	---

element cfPers__Type/cfPersName_Pers/cfFamilyNames

diagram	
namespace	urn:xmlns:org:eurocris:cerif-1.6-2
type	xs:string
properties	isRef 0 minOcc 0 maxOcc 1 content simple
source	<xs:element name="cfFamilyNames" type="xs:string" minOccurs="0"/>

element cfPers__Type/cfPersName_Pers/cfFirstNames

diagram	
namespace	urn:xmlns:org:eurocris:cerif-1.6-2
type	xs:string
properties	isRef 0 minOcc 0 maxOcc 1 content simple
source	<xs:element name="cfFirstNames" type="xs:string" minOccurs="0"/>

element cfPers__Type/cfPersName_Pers/cfOtherNames

diagram	
namespace	urn:xmlns:org:eurocris:cerif-1.6-2
type	xs:string
properties	isRef 0 minOcc 0 maxOcc 1 content simple
source	<xs:element name="cfOtherNames" type="xs:string" minOccurs="0"/>

element cfPers__Type/cfPers_Meas

diagram	
namespace	urn:xmlns:org:eurocris:cerif-1.6-2
properties	isRef 0 content complex
children	cfMeasId cfClassId cfClassSchemeld cfStartDate cfEndDate cfFraction
source	<xs:element name="cfPers_Meas"> <xs:complexType> <xs:sequence>

	<pre><xs:element name="cfMeasId" type="cflD__Type"/> <xs:group ref="cfCoreClassWithFraction__Group"/> </xs:sequence> </xs:complexType> </xs:element></pre>
--	--

element cfPers__Type/cfPers_Meas/cfMeasId

diagram	
namespace	urn:xmlns:org:eurocris:cerif-1.6-2
type	cflD__Type
properties	isRef 0 content simple
facets	Kind Value annotation maxLength 128
source	<pre><xs:element name="cfMeasId" type="cflD__Type"/></pre>

element cfPers__Type/cfPers_Indic

diagram	
namespace	urn:xmlns:org:eurocris:cerif-1.6-2
properties	isRef 0 content complex
children	cflIndicId cfClassId cfClassSchemeId cfStartDate cfEndDate cfFraction
source	<pre><xs:element name="cfPers_Indic"> <xs:complexType> <xs:sequence> <xs:element name="cflIndicId" type="cflD__Type"/> <xs:group ref="cfCoreClassWithFraction__Group"/> </xs:sequence> </xs:complexType> </xs:element></pre>

element cfPers__Type/cfPers_Indic/cflIndicId

diagram	
namespace	urn:xmlns:org:eurocris:cerif-1.6-2
type	cflD__Type
properties	isRef 0 content simple
facets	Kind Value annotation maxLength 128
source	<pre><xs:element name="cflIndicId" type="cflD__Type"/></pre>

element **cfPers__Type/cfFedId**

diagram	
namespace	urn:xmlns:org:eurocris:cerif-1.6-2
type	cfFedId__EmbType
properties	isRef 0 content complex
children	cfFedIdId cfFedId cfClassId cfClassSchemeld cfStartDate cfEndDate cfFedId__Class
source	<code><xs:element name="cfFedId" type="cfFedId__EmbType"/></code>

complexType **cfPers__Class__Type**

diagram	
namespace	urn:xmlns:org:eurocris:cerif-1.6-2
children	cfPersId cfClassId cfClassSchemeld cfStartDate cfEndDate cfFraction
used by	element CERIF/cfPers__Class
source	<pre> <xs:complexType name="cfPers__Class__Type"> <xs:sequence> <xs:element name="cfPersId" type="cfId__Type"/> <xs:group ref="cfCoreClassWithFraction__Group"/> </xs:sequence> </xs:complexType> </pre>

element **cfPers__Class__Type/cfPersId**

diagram	
namespace	urn:xmlns:org:eurocris:cerif-1.6-2
type	cfId__Type
properties	isRef 0 content simple

facets	Kind maxLength	Value 128	annotation
source	<xs:element name="cfPersId" type="cfId__Type"/>		

complexType cfPers_Country__Type

diagram	
namespace	urn:xmlns:org:eurocris:cerif-1.6-2
children	cfPersId cfCountryCode cfClassId cfClassSchemeld cfStartDate cfEndDate cfFraction
used by	element CERIF/cfPers_Country
source	<pre><xs:complexType name="cfPers_Country__Type"> <xs:sequence> <xs:element name="cfPersId" type="cfId__Type"/> <xs:element name="cfCountryCode" type="xs:string"/> <xs:group ref="cfCoreClassWithFraction__Group"/> </xs:sequence> </xs:complexType></pre>

element cfPers_Country__Type/cfPersId

diagram			
namespace	urn:xmlns:org:eurocris:cerif-1.6-2		
type	cfId__Type		
properties	isRef 0 content simple		
facets	Kind maxLength	Value 128	annotation
source	<xs:element name="cfPersId" type="cfId__Type"/>		

element cfPers_Country__Type/cfCountryCode

diagram			
namespace	urn:xmlns:org:eurocris:cerif-1.6-2		
type	xs:string		
properties	isRef 0 content simple		
source	<xs:element name="cfCountryCode" type="xs:string"/>		

complexType cfPers_CV_Type

diagram	
namespace	urn:xmlns:org:eurocris:cerif-1.6-2
children	cfPersId cfCVId cfClassId cfClassSchemeld cfStartDate cfEndDate cfFraction
source	<pre><xs:complexType name="cfPers_CV_Type"> <xs:sequence> <xs:element name="cfPersId" type="cflD__Type"/> <xs:element name="cfCVId" type="cflD__Type"/> <xs:group ref="cfCoreClassWithFraction_Group"/> </xs:sequence> </xs:complexType></pre>

element cfPers_CV_Type/cfPersId

diagram	
namespace	urn:xmlns:org:eurocris:cerif-1.6-2
type	cflD_Type
properties	isRef 0 content simple
facets	Kind Value annotation maxLength 128
source	<pre><xs:element name="cfPersId" type="cflD__Type"/></pre>

element cfPers_CV_Type/cfCVId

diagram	
namespace	urn:xmlns:org:eurocris:cerif-1.6-2
type	cflD_Type
properties	isRef 0 content simple
facets	Kind Value annotation maxLength 128
source	<pre><xs:element name="cfCVId" type="cflD__Type"/></pre>

complexType **cfPers_DC_Type**

diagram	
namespace	urn:xmlns:org:eurocris:cerif-1.6-2
children	cfPersId cfDCId cfDCScheme cfClassId cfClassSchemeId cfStartDate cfEndDate cfFraction
used by	element CERIF/cfPers_DC
source	<pre> <xs:complexType name="cfPers_DC_Type"> <xs:sequence> <xs:element name="cfPersId" type="cfId_Type"/> <xs:element name="cfDCId" type="xs:string"/> <xs:element name="cfDCScheme" type="xs:string"/> <xs:group ref="cfCoreClassWithFraction_Group"/> </xs:sequence> </xs:complexType> </pre>

element **cfPers_DC_Type/cfPersId**

diagram							
namespace	urn:xmlns:org:eurocris:cerif-1.6-2						
type	cfId_Type						
properties	isRef 0 content simple						
facets	<table border="1"> <thead> <tr> <th>Kind</th> <th>Value</th> <th>annotation</th> </tr> </thead> <tbody> <tr> <td>maxLength</td> <td>128</td> <td></td> </tr> </tbody> </table>	Kind	Value	annotation	maxLength	128	
Kind	Value	annotation					
maxLength	128						
source	<pre><xs:element name="cfPersId" type="cfId_Type"/></pre>						

element **cfPers_DC_Type/cfDCId**

diagram	
namespace	urn:xmlns:org:eurocris:cerif-1.6-2
type	xs:string
properties	isRef 0 content simple
source	<pre><xs:element name="cfDCId" type="xs:string"/></pre>

element **cfPers_DC_Type/cfDCScheme**

diagram	
namespace	urn:xmlns:org:eurocris:cerif-1.6-2
type	xs:string
properties	isRef 0 content simple

source	<code><xs:element name="cfDCScheme" type="xs:string"/></code>
--------	---

complexType cfPers_EAddr_Type

diagram	
namespace	urn:xmlns:org:eurocris:cerif-1.6-2
children	cfPersId cfEAddrId cfClassId cfClassSchemeId cfStartDate cfEndDate cfFraction
used by	element CERIF/cfPers_EAddr
source	<pre> <xs:complexType name="cfPers_EAddr_Type"> <xs:sequence> <xs:element name="cfPersId" type="cflD_Type"/> <xs:element name="cfEAddrId" type="cflD_Type"/> <xs:group ref="cfCoreClassWithFraction_Group"/> </xs:sequence> </xs:complexType> </pre>

element cfPers_EAddr_Type/cfPersId

diagram	
namespace	urn:xmlns:org:eurocris:cerif-1.6-2
type	cflD_Type
properties	isRef 0 content simple
facets	Kind Value annotation maxLength 128
source	<code><xs:element name="cfPersId" type="cflD_Type"/></code>

element cfPers_EAddr_Type/cfEAddrId

diagram	
namespace	urn:xmlns:org:eurocris:cerif-1.6-2
type	cflD_Type
properties	isRef 0 content simple
facets	Kind Value annotation maxLength 128
source	<code><xs:element name="cfEAddrId" type="cflD_Type"/></code>

complexType **cfPers_Event_Type**

diagram	
namespace	urn:xmlns:org:eurocris:cerif-1.6-2
children	cfPersId cfEventId cfClassId cfClassSchemeld cfStartDate cfEndDate cfFraction
used by	element CERIF/cfPers_Event
source	<pre><xs:complexType name="cfPers_Event_Type"> <xs:sequence> <xs:element name="cfPersId" type="cfd__Type"/> <xs:element name="cfEventId" type="cfd__Type"/> <xs:group ref="cfCoreClassWithFraction_Group"/> </xs:sequence> </xs:complexType></pre>

element **cfPers_Event_Type/cfPersId**

diagram	
namespace	urn:xmlns:org:eurocris:cerif-1.6-2
type	cfd__Type
properties	isRef 0 content simple
facets	Kind Value annotation maxLength 128
source	<pre><xs:element name="cfPersId" type="cfd__Type"/></pre>

element **cfPers_Event_Type/cfEventId**

diagram	
namespace	urn:xmlns:org:eurocris:cerif-1.6-2
type	cfd__Type
properties	isRef 0 content simple
facets	Kind Value annotation maxLength 128
source	<pre><xs:element name="cfEventId" type="cfd__Type"/></pre>

complexType **cfPers_Fund_Type**

diagram	
namespace	urn:xmlns:org:eurocris:cerif-1.6-2
children	cfPersId cfFundId cfClassId cfClassSchemeld cfStartDate cfEndDate cfFraction cfAmount
used by	element CERIF/cfPers_Fund
source	<pre> <xs:complexType name="cfPers_Fund_Type"> <xs:sequence> <xs:element name="cfPersId" type="cfId__Type"/> <xs:element name="cfFundId" type="cfId__Type"/> <xs:group ref="cfCoreClassWithFraction_Group"/> <xs:element name="cfAmount" type="cfAmount__Type" minOccurs="0"/> </xs:sequence> </xs:complexType> </pre>

element **cfPers_Fund_Type/cfPersId**

diagram	
namespace	urn:xmlns:org:eurocris:cerif-1.6-2
type	cfId__Type
properties	isRef 0 content simple
facets	Kind Value annotation maxLength 128
source	<pre><xs:element name="cfPersId" type="cfId__Type"/></pre>

element **cfPers_Fund_Type/cfFundId**

diagram	
namespace	urn:xmlns:org:eurocris:cerif-1.6-2
type	cfId__Type
properties	isRef 0 content simple
facets	Kind Value annotation maxLength 128
source	<pre><xs:element name="cfFundId" type="cfId__Type"/></pre>

element **cfPers_Fund_Type/cfAmount**

diagram													
namespace	urn:xmlns:org:eurocris:cerif-1.6-2												
type	cfAmount_Type												
properties	isRef 0 minOcc 0 maxOcc 1 content complex												
attributes	<table border="1"> <thead> <tr> <th>Name</th> <th>Type</th> <th>Use</th> <th>Default</th> <th>Fixed</th> <th>annotation</th> </tr> </thead> <tbody> <tr> <td>cfCurrCode</td> <td>xs:string</td> <td>required</td> <td></td> <td></td> <td></td> </tr> </tbody> </table>	Name	Type	Use	Default	Fixed	annotation	cfCurrCode	xs:string	required			
Name	Type	Use	Default	Fixed	annotation								
cfCurrCode	xs:string	required											
source	<code><xs:element name="cfAmount" type="cfAmount_Type" minOccurs="0"/></code>												

complexType **cfPers_Indic_Type**

diagram	
namespace	urn:xmlns:org:eurocris:cerif-1.6-2
children	cfPersId cfIndicId cfClassId cfClassSchemeld cfStartDate cfEndDate cfFraction
used by	element CERIF/cfPers_Indic
source	<pre> <xs:complexType name="cfPers_Indic_Type"> <xs:sequence> <xs:element name="cfPersId" type="cflD_Type"/> <xs:element name="cfIndicId" type="cflD_Type"/> <xs:group ref="cfCoreClassWithFraction_Group"/> </xs:sequence> </xs:complexType> </pre>

element **cfPers_Indic_Type/cfPersId**

diagram							
namespace	urn:xmlns:org:eurocris:cerif-1.6-2						
type	cflD_Type						
properties	isRef 0 content simple						
facets	<table border="1"> <thead> <tr> <th>Kind</th> <th>Value</th> <th>annotation</th> </tr> </thead> <tbody> <tr> <td>maxLength</td> <td>128</td> <td></td> </tr> </tbody> </table>	Kind	Value	annotation	maxLength	128	
Kind	Value	annotation					
maxLength	128						
source	<code><xs:element name="cfPersId" type="cflD_Type"/></code>						

element **cfPers_Indic_Type/cfIndicId**

diagram	
namespace	urn:xmlns:org:eurocris:cerif-1.6-2
type	cfd_Type
properties	isRef 0 content simple
facets	Kind Value annotation maxLength 128
source	<code><xs:element name="cfIndicId" type="cfd_Type"/></code>

complexType **cfPers_Lang_Type**

diagram	
namespace	urn:xmlns:org:eurocris:cerif-1.6-2
children	cfPersId cfLangCode cfClassId cfClassSchemeld cfStartDate cfEndDate cfFraction cfSkillReading cfSkillSpeaking cfSkillWriting
used by	element CERIF/cfPers_Lang
source	<pre><xs:complexType name="cfPers_Lang_Type"> <xs:sequence> <xs:element name="cfPersId" type="cfd_Type"/> <xs:element name="cfLangCode" type="xs:string"/> <xs:group ref="cfCoreClassWithFraction_Group"/> <xs:element name="cfSkillReading" type="xs:string" minOccurs="0"/> <xs:element name="cfSkillSpeaking" type="xs:string" minOccurs="0"/> <xs:element name="cfSkillWriting" type="xs:string" minOccurs="0"/> </xs:sequence> </xs:complexType></pre>

element **cfPers_Lang_Type/cfPersId**

diagram	
namespace	urn:xmlns:org:eurocris:cerif-1.6-2
type	cfd_Type
properties	isRef 0 content simple
facets	Kind Value annotation maxLength 128
source	<code><xs:element name="cfPersId" type="cfd_Type"/></code>

element **cfPers_Lang_Type/cfLangCode**

diagram	
namespace	urn:xmlns:org:eurocris:cerif-1.6-2
type	xs:string
properties	isRef 0 content simple
source	<code><xs:element name="cfLangCode" type="xs:string"/></code>

element **cfPers_Lang_Type/cfSkillReading**

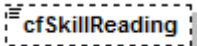
diagram	
namespace	urn:xmlns:org:eurocris:cerif-1.6-2
type	xs:string
properties	isRef 0 minOcc 0 maxOcc 1 content simple
source	<code><xs:element name="cfSkillReading" type="xs:string" minOccurs="0"/></code>

element **cfPers_Lang_Type/cfSkillSpeaking**

diagram	
namespace	urn:xmlns:org:eurocris:cerif-1.6-2
type	xs:string
properties	isRef 0 minOcc 0 maxOcc 1 content simple
source	<code><xs:element name="cfSkillSpeaking" type="xs:string" minOccurs="0"/></code>

element **cfPers_Lang_Type/cfSkillWriting**

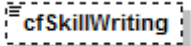
diagram	
namespace	urn:xmlns:org:eurocris:cerif-1.6-2
type	xs:string
properties	isRef 0 minOcc 0 maxOcc 1 content simple
source	<code><xs:element name="cfSkillWriting" type="xs:string" minOccurs="0"/></code>

complexType **cfPers_Meas__Type**

diagram	
namespace	urn:xmlns:org:eurocris:cerif-1.6-2
children	cfPersId cfMeasId cfClassId cfClassSchemeld cfStartDate cfEndDate cfFraction
used by	element CERIF/cfPers_Meas
source	<pre><xs:complexType name="cfPers_Meas__Type"> <xs:sequence> <xs:element name="cfPersId" type="cfId__Type"/> <xs:element name="cfMeasId" type="cfId__Type"/> <xs:group ref="cfCoreClassWithFraction__Group"/> </xs:sequence> </xs:complexType></pre>

element **cfPers_Meas__Type/cfPersId**

diagram	
namespace	urn:xmlns:org:eurocris:cerif-1.6-2
type	cfId__Type
properties	isRef 0 content simple
facets	Kind Value annotation maxLength 128
source	<pre><xs:element name="cfPersId" type="cfId__Type"/></pre>

element **cfPers_Meas__Type/cfMeasId**

diagram	
namespace	urn:xmlns:org:eurocris:cerif-1.6-2
type	cfId__Type
properties	isRef 0 content simple
facets	Kind Value annotation maxLength 128
source	<pre><xs:element name="cfMeasId" type="cfId__Type"/></pre>

complexType **cfPers_OrgUnit_Type**

diagram	
namespace	urn:xmlns:org:eurocris:cerif-1.6-2
children	cfPersId cfOrgUnitId cfClassId cfClassSchemeld cfStartDate cfEndDate cfFraction
used by	element CERIF/cfPers_OrgUnit
source	<pre><xs:complexType name="cfPers_OrgUnit_Type"> <xs:sequence> <xs:element name="cfPersId" type="cflD__Type"/> <xs:element name="cfOrgUnitId" type="cflD__Type"/> <xs:group ref="cfCoreClassWithFraction_Group"/> </xs:sequence> </xs:complexType></pre>

element **cfPers_OrgUnit_Type/cfPersId**

diagram	
namespace	urn:xmlns:org:eurocris:cerif-1.6-2
type	cflD_Type
properties	isRef 0 content simple
facets	Kind Value annotation maxLength 128
source	<pre><xs:element name="cfPersId" type="cflD__Type"/></pre>

element **cfPers_OrgUnit_Type/cfOrgUnitId**

diagram	
namespace	urn:xmlns:org:eurocris:cerif-1.6-2
type	cflD_Type
properties	isRef 0 content simple
facets	Kind Value annotation maxLength 128
source	<pre><xs:element name="cfOrgUnitId" type="cflD__Type"/></pre>

complexType **cfPers_PAddr_Type**

diagram	
namespace	urn:xmlns:org:eurocris:cerif-1.6-2
children	cfPersId cfPAddrId cfClassId cfClassSchemeld cfStartDate cfEndDate cfFraction
used by	element CERIF/cfPers_PAddr
source	<pre><xs:complexType name="cfPers_PAddr_Type"> <xs:sequence> <xs:element name="cfPersId" type="cfId__Type"/> <xs:element name="cfPAddrId" type="cfId__Type"/> <xs:group ref="cfCoreClassWithFraction_Group"/> </xs:sequence> </xs:complexType></pre>

element **cfPers_PAddr_Type/cfPersId**

diagram	
namespace	urn:xmlns:org:eurocris:cerif-1.6-2
type	cfId_Type
properties	isRef 0 content simple
facets	Kind Value annotation maxLength 128
source	<pre><xs:element name="cfPersId" type="cfId__Type"/></pre>

element **cfPers_PAddr_Type/cfPAddrId**

diagram	
namespace	urn:xmlns:org:eurocris:cerif-1.6-2
type	cfId_Type
properties	isRef 0 content simple
facets	Kind Value annotation maxLength 128
source	<pre><xs:element name="cfPAddrId" type="cfId__Type"/></pre>

complexType **cfPers_Pers__Type**

diagram	
namespace	urn:xmlns:org:eurocris:cerif-1.6-2
children	cfPersId1 cfPersId2 cfClassId cfClassSchemeId cfStartDate cfEndDate cfFraction
used by	element CERIF/cfPers_Pers
source	<pre> <xs:complexType name="cfPers_Pers__Type"> <xs:sequence> <xs:element name="cfPersId1" type="cfld__Type"/> <xs:element name="cfPersId2" type="cfld__Type"/> <xs:group ref="cfCoreClassWithFraction__Group"/> </xs:sequence> </xs:complexType> </pre>

element **cfPers_Pers__Type/cfPersId1**

diagram							
namespace	urn:xmlns:org:eurocris:cerif-1.6-2						
type	cfld__Type						
properties	isRef 0 content simple						
facets	<table border="1"> <thead> <tr> <th>Kind</th> <th>Value</th> <th>annotation</th> </tr> </thead> <tbody> <tr> <td>maxLength</td> <td>128</td> <td></td> </tr> </tbody> </table>	Kind	Value	annotation	maxLength	128	
Kind	Value	annotation					
maxLength	128						
source	<pre><xs:element name="cfPersId1" type="cfld__Type"/></pre>						

element **cfPers_Pers__Type/cfPersId2**

diagram							
namespace	urn:xmlns:org:eurocris:cerif-1.6-2						
type	cfld__Type						
properties	isRef 0 content simple						
facets	<table border="1"> <thead> <tr> <th>Kind</th> <th>Value</th> <th>annotation</th> </tr> </thead> <tbody> <tr> <td>maxLength</td> <td>128</td> <td></td> </tr> </tbody> </table>	Kind	Value	annotation	maxLength	128	
Kind	Value	annotation					
maxLength	128						
source	<pre><xs:element name="cfPersId2" type="cfld__Type"/></pre>						

complexType **cfPers_Qual_Type**

diagram	
namespace	urn:xmlns:org:eurocris:cerif-1.6-2
children	cfPersId cfQualId cfClassId cfClassSchemeld cfStartDate cfEndDate cfFraction
used by	element CERIF/cfPers_Qual
source	<pre><xs:complexType name="cfPers_Qual_Type"> <xs:sequence> <xs:element name="cfPersId" type="cfd__Type"/> <xs:element name="cfQualId" type="cfd__Type"/> <xs:group ref="cfCoreClassWithFraction_Group"/> </xs:sequence> </xs:complexType></pre>

element **cfPers_Qual_Type/cfPersId**

diagram	
namespace	urn:xmlns:org:eurocris:cerif-1.6-2
type	cfd__Type
properties	isRef 0 content simple
facets	Kind Value annotation maxLength 128
source	<pre><xs:element name="cfPersId" type="cfd__Type"/></pre>

element **cfPers_Qual_Type/cfQualId**

diagram	
namespace	urn:xmlns:org:eurocris:cerif-1.6-2
type	cfd__Type
properties	isRef 0 content simple
facets	Kind Value annotation maxLength 128
source	<pre><xs:element name="cfQualId" type="cfd__Type"/></pre>

complexType **cfPers_ResPubl__Type**

diagram	
namespace	urn.xmlns:org:eurocris:cerif-1.6-2
children	cfPersId cfResPublId cfClassId cfClassSchemeId cfStartDate cfEndDate cfFraction cfCopyright cfOrder
used by	element CERIF/cfPers_ResPubl
source	<pre> <xs:complexType name="cfPers_ResPubl__Type"> <xs:sequence> <xs:element name="cfPersId" type="cfd__Type"/> <xs:element name="cfResPublId" type="cfd__Type"/> <xs:group ref="cfCoreClassWithFraction_Group"/> <xs:element name="cfCopyright" type="xs:string" minOccurs="0"/> <xs:element name="cfOrder" type="xs:int" minOccurs="0"/> </xs:sequence> </xs:complexType> </pre>

element **cfPers_ResPubl__Type/cfPersId**

diagram	
namespace	urn.xmlns:org:eurocris:cerif-1.6-2
type	cfd__Type
properties	isRef 0 content simple
facets	Kind Value annotation maxLength 128
source	<pre><xs:element name="cfPersId" type="cfd__Type"/></pre>

element **cfPers_ResPubl__Type/cfResPublId**

diagram	
namespace	urn.xmlns:org:eurocris:cerif-1.6-2
type	cfd__Type
properties	isRef 0 content simple
facets	Kind Value annotation maxLength 128
source	<pre><xs:element name="cfResPublId" type="cfd__Type"/></pre>

element **cfPers_ResPubl__Type/cfCopyright**

diagram	
namespace	urn:xmlns:org:eurocris:cerif-1.6-2
type	xs:string
properties	isRef 0 minOcc 0 maxOcc 1 content simple
source	<code><xs:element name="cfCopyright" type="xs:string" minOccurs="0"/></code>

element **cfPers_ResPubl__Type/cfOrder**

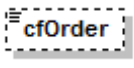
diagram	
namespace	urn:xmlns:org:eurocris:cerif-1.6-2
type	xs:int
properties	isRef 0 minOcc 0 maxOcc 1 content simple
source	<code><xs:element name="cfOrder" type="xs:int" minOccurs="0"/></code>

complexType **cfPersKeyw__Type**

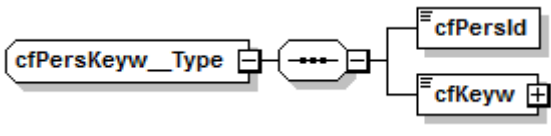
diagram	
namespace	urn:xmlns:org:eurocris:cerif-1.6-2
children	cfPersId cfKeyw
used by	element CERIF/cfPersKeyw
source	<code><xs:complexType name="cfPersKeyw__Type"> <xs:sequence> <xs:element name="cfPersId" type="cfId__Type"/> <xs:element name="cfKeyw" type="cfMLangString__Type"/> </xs:sequence> </xs:complexType></code>

element **cfPersKeyw__Type/cfPersId**

diagram	
namespace	urn:xmlns:org:eurocris:cerif-1.6-2
type	cfId__Type
properties	isRef 0 content simple
facets	Kind Value annotation maxLength 128
source	<code><xs:element name="cfPersId" type="cfId__Type"/></code>

element **cfPersKeyw__Type**/cfKeyw

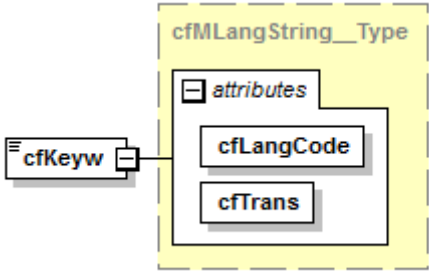
diagram																			
namespace	urn:xmlns:org:eurocris:cerif-1.6-2																		
type	cfMLangString__Type																		
properties	isRef 0 content complex																		
attributes	<table border="1"> <thead> <tr> <th>Name</th> <th>Type</th> <th>Use</th> <th>Default</th> <th>Fixed</th> <th>annotation</th> </tr> </thead> <tbody> <tr> <td>cfLangCode</td> <td>xs:string</td> <td>required</td> <td></td> <td></td> <td></td> </tr> <tr> <td>cfTrans</td> <td>cfTrans__Type</td> <td>required</td> <td></td> <td></td> <td></td> </tr> </tbody> </table>	Name	Type	Use	Default	Fixed	annotation	cfLangCode	xs:string	required				cfTrans	cfTrans__Type	required			
Name	Type	Use	Default	Fixed	annotation														
cfLangCode	xs:string	required																	
cfTrans	cfTrans__Type	required																	
source	<code><xs:element name="cfKeyw" type="cfMLangString__Type"/></code>																		

complexType **cfPersName__Type**

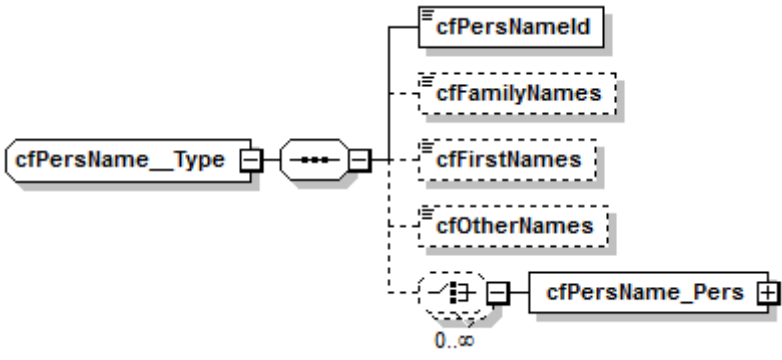
diagram	
namespace	urn:xmlns:org:eurocris:cerif-1.6-2
children	cfPersNameId cfFamilyNames cfFirstNames cfOtherNames cfPersName_Pers
used by	element CERIF/cfPersName
source	<pre> <xs:complexType name="cfPersName__Type"> <xs:sequence> <xs:element name="cfPersNameId" type="cfId__Type"/> <xs:element name="cfFamilyNames" type="xs:string" minOccurs="0"/> <xs:element name="cfFirstNames" type="xs:string" minOccurs="0"/> <xs:element name="cfOtherNames" type="xs:string" minOccurs="0"/> <xs:choice minOccurs="0" maxOccurs="unbounded"> <!-- embedded linking entities --> <xs:element name="cfPersName_Pers"> <xs:complexType> <xs:sequence> <xs:element name="cfPersId" type="cfId__Type"/> <xs:group ref="cfCoreClass__Group"/> </xs:sequence> </xs:complexType> </xs:element> </xs:choice> </xs:sequence> </xs:complexType> </pre>

element **cfPersName_Type/cfPersNameId**

diagram	
namespace	urn:xmlns:org:eurocris:cerif-1.6-2
type	cflid_Type
properties	isRef 0 content simple
facets	Kind Value annotation maxLength 128
source	<code><xs:element name="cfPersNameId" type="cflid_Type"/></code>

element **cfPersName_Type/cfFamilyNames**

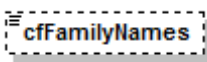
diagram	
namespace	urn:xmlns:org:eurocris:cerif-1.6-2
type	xs:string
properties	isRef 0 minOcc 0 maxOcc 1 content simple
source	<code><xs:element name="cfFamilyNames" type="xs:string" minOccurs="0"/></code>

element **cfPersName_Type/cfFirstNames**

diagram	
namespace	urn:xmlns:org:eurocris:cerif-1.6-2
type	xs:string
properties	isRef 0 minOcc 0 maxOcc 1 content simple
source	<code><xs:element name="cfFirstNames" type="xs:string" minOccurs="0"/></code>

element **cfPersName_Type/cfOtherNames**

diagram	
namespace	urn:xmlns:org:eurocris:cerif-1.6-2
type	xs:string
properties	isRef 0 minOcc 0 maxOcc 1 content simple
source	<code><xs:element name="cfOtherNames" type="xs:string" minOccurs="0"/></code>

element **cfPersName__Type/cfPersName_Pers**

diagram	
namespace	urn:xmlns:org:eurocris:cerif-1.6-2
properties	isRef 0 content complex
children	cfPersId cfClassId cfClassSchemeld cfStartDate cfEndDate
source	<pre> <xs:element name="cfPersName_Pers"> <xs:complexType> <xs:sequence> <xs:element name="cfPersId" type="cfId__Type"/> <xs:group ref="cfCoreClass__Group"/> </xs:sequence> </xs:complexType> </xs:element> </pre>

element **cfPersName__Type/cfPersName_Pers/cfPersId**

diagram	
namespace	urn:xmlns:org:eurocris:cerif-1.6-2
type	cfId__Type
properties	isRef 0 content simple
facets	Kind Value annotation maxLength 128
source	<pre> <xs:element name="cfPersId" type="cfId__Type"/> </pre>

complexType cfPersName_Pers__Type

diagram	
namespace	urn:xmlns:org:eurocris:cerif-1.6-2
children	cfPersNameId cfPersId cfClassId cfClassSchemId cfStartDate cfEndDate cfFamilyNames cfFirstNames cfOtherNames
used by	element CERIF/cfPersName_Pers
source	<pre><xs:complexType name="cfPersName_Pers__Type"> <xs:sequence> <xs:element name="cfPersNameId" type="cfId__Type"/> <xs:element name="cfPersId" type="cfId__Type"/> <xs:group ref="cfCoreClass_Group"/> <xs:element name="cfFamilyNames" type="xs:string" minOccurs="0"/> <xs:element name="cfFirstNames" type="xs:string" minOccurs="0"/> <xs:element name="cfOtherNames" type="xs:string" minOccurs="0"/> </xs:sequence> </xs:complexType></pre>

element cfPersName_Pers__Type/cfPersNameId

diagram	
namespace	urn:xmlns:org:eurocris:cerif-1.6-2
type	cfId__Type
properties	isRef 0 content simple
facets	Kind Value annotation maxLength 128
source	<pre><xs:element name="cfPersNameId" type="cfId__Type"/></pre>

element cfPersName_Pers__Type/cfPersId

diagram	
namespace	urn:xmlns:org:eurocris:cerif-1.6-2
type	cfId__Type
properties	isRef 0 content simple
facets	Kind Value annotation maxLength 128

source	<code><xs:element name="cfPersId" type="cfId__Type"/></code>
--------	--

element cfPersName_Pers__Type/cfFamilyNames

diagram	
namespace	urn:xmlns:org:eurocris:cerif-1.6-2
type	xs:string
properties	isRef 0 minOcc 0 maxOcc 1 content simple
source	<code><xs:element name="cfFamilyNames" type="xs:string" minOccurs="0"/></code>

element cfPersName_Pers__Type/cfFirstNames

diagram	
namespace	urn:xmlns:org:eurocris:cerif-1.6-2
type	xs:string
properties	isRef 0 minOcc 0 maxOcc 1 content simple
source	<code><xs:element name="cfFirstNames" type="xs:string" minOccurs="0"/></code>

element cfPersName_Pers__Type/cfOtherNames

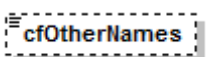
diagram	
namespace	urn:xmlns:org:eurocris:cerif-1.6-2
type	xs:string
properties	isRef 0 minOcc 0 maxOcc 1 content simple
source	<code><xs:element name="cfOtherNames" type="xs:string" minOccurs="0"/></code>

complexType cfPersResInt__Type

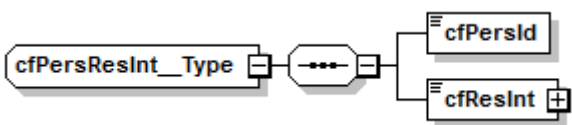
diagram	
namespace	urn:xmlns:org:eurocris:cerif-1.6-2
children	cfPersId cfResInt
used by	element CERIF/cfPersResInt
source	<pre><xs:complexType name="cfPersResInt__Type"> <xs:sequence> <xs:element name="cfPersId" type="cfId__Type"/> <xs:element name="cfResInt" type="cfMLangString__Type"/> </xs:sequence> </xs:complexType></pre>

element **cfPersResInt__Type/cfPersId**

diagram	
namespace	urn.xmlns:org:eurocris:cerif-1.6-2
type	cfd__Type
properties	isRef 0 content simple
facets	Kind Value annotation maxLength 128
source	<code><xs:element name="cfPersId" type="cfd__Type"/></code>

element **cfPersResInt__Type/cfResInt**

diagram																			
namespace	urn.xmlns:org:eurocris:cerif-1.6-2																		
type	cfMLangString__Type																		
properties	isRef 0 content complex																		
attributes	<table border="1"> <thead> <tr> <th>Name</th> <th>Type</th> <th>Use</th> <th>Default</th> <th>Fixed</th> <th>annotation</th> </tr> </thead> <tbody> <tr> <td>cfLangCode</td> <td>xs:string</td> <td>required</td> <td></td> <td></td> <td></td> </tr> <tr> <td>cfTrans</td> <td>cfTrans__Type</td> <td>required</td> <td></td> <td></td> <td></td> </tr> </tbody> </table>	Name	Type	Use	Default	Fixed	annotation	cfLangCode	xs:string	required				cfTrans	cfTrans__Type	required			
Name	Type	Use	Default	Fixed	annotation														
cfLangCode	xs:string	required																	
cfTrans	cfTrans__Type	required																	
source	<code><xs:element name="cfResInt" type="cfMLangString__Type"/></code>																		

complexType cfProj__Type

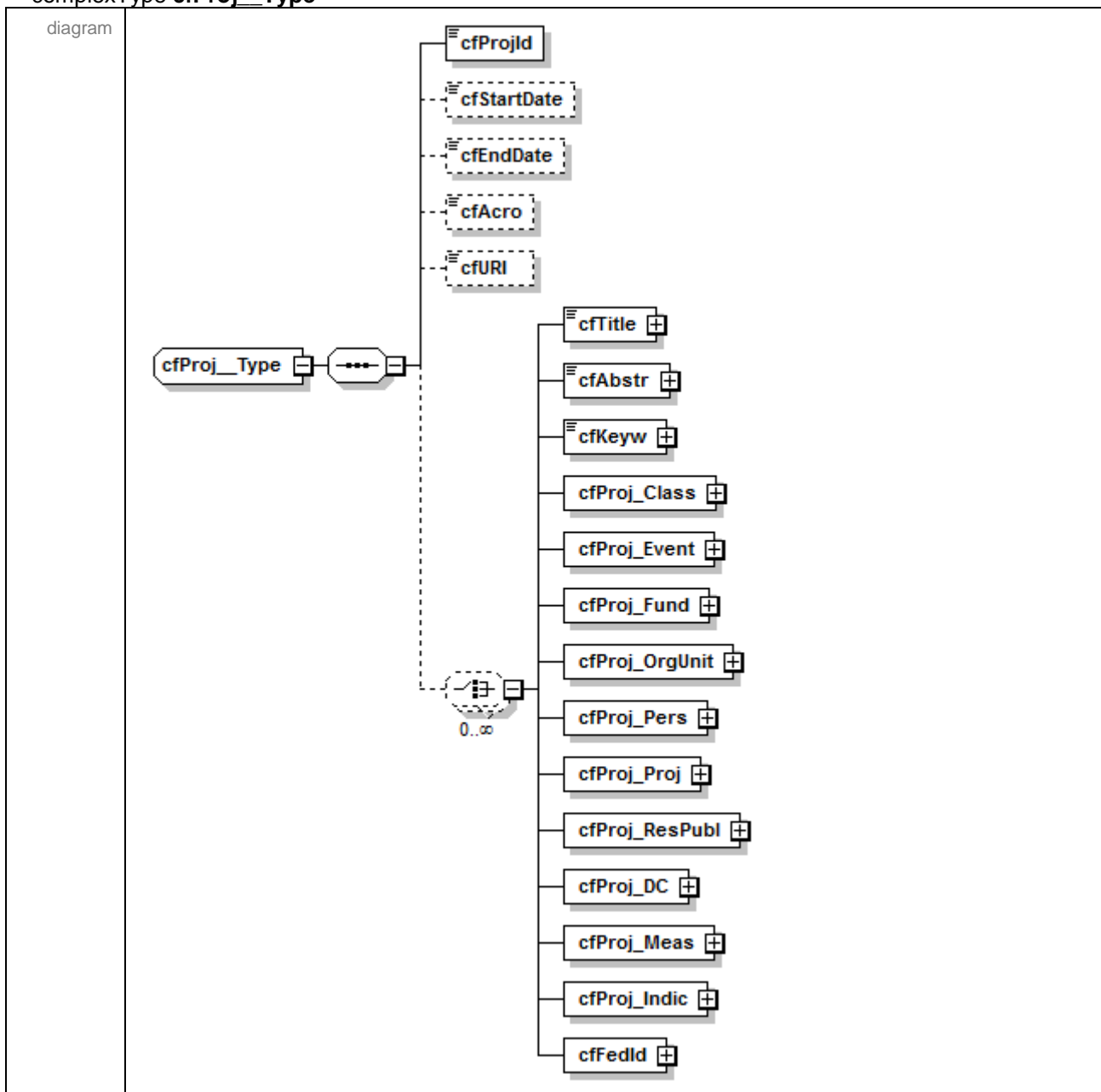

namespace urn:xmlns:org:eurocris:cerif-1.6-2

children [cfProjId](#) [cfStartDate](#) [cfEndDate](#) [cfAcro](#) [cfURI](#) [cfTitle](#) [cfAbstr](#) [cfKeyw](#) [cfProj_Class](#) [cfProj_Event](#) [cfProj_Fund](#) [cfProj_OrgUnit](#) [cfProj_Pers](#) [cfProj_Proj](#) [cfProj_ResPubl](#) [cfProj_DC](#) [cfProj_Meas](#) [cfProj_Indic](#) [cfFedId](#)

used by element [CERIF/cfProj](#)

```

<xs:complexType name="cfProj__Type">
  <xs:sequence>
    <xs:element name="cfProjId" type="cfId__Type"/>
    <xs:element name="cfStartDate" type="xs:date" minOccurs="0"/>
    <xs:element name="cfEndDate" type="xs:date" minOccurs="0"/>
    <xs:element name="cfAcro" type="xs:string" minOccurs="0"/>
    <xs:element name="cfURI" type="xs:string" minOccurs="0"/>
    <xs:choice minOccurs="0" maxOccurs="unbounded">
      <!-- embedded multiple-language attributes -->
      <xs:element name="cfTitle" type="cfMLangString__Type"/>
      <xs:element name="cfAbstr" type="cfMLangString__Type"/>
      <xs:element name="cfKeyw" type="cfMLangString__Type"/>
      <!-- embedded linking entities -->
      <xs:element name="cfProj_Class" type="cfCoreClassWithFraction__Type"/>
    
```

```

<xs:element name="cfProj_Event">
  <xs:complexType>
    <xs:sequence>
      <xs:element name="cfEventId" type="cfId__Type"/>
      <xs:group ref="cfCoreClassWithFraction__Group"/>
    </xs:sequence>
  </xs:complexType>
</xs:element>
<xs:element name="cfProj_Fund">
  <xs:complexType>
    <xs:sequence>
      <xs:element name="cfFundId" type="cfId__Type"/>
      <xs:group ref="cfCoreClassWithFraction__Group"/>
      <xs:element name="cfAmount" type="cfAmount__Type" minOccurs="0"/>
    </xs:sequence>
  </xs:complexType>
</xs:element>
<xs:element name="cfProj_OrgUnit">
  <xs:complexType>
    <xs:sequence>
      <xs:element name="cfOrgUnitId" type="cfId__Type"/>
      <xs:group ref="cfCoreClassWithFraction__Group"/>
    </xs:sequence>
  </xs:complexType>
</xs:element>
<xs:element name="cfProj_Pers">
  <xs:complexType>
    <xs:sequence>
      <xs:element name="cfPersId" type="cfId__Type"/>
      <xs:group ref="cfCoreClassWithFraction__Group"/>
    </xs:sequence>
  </xs:complexType>
</xs:element>
<xs:element name="cfProj_Proj">
  <xs:complexType>
    <xs:sequence>
      <xs:choice>
        <xs:element name="cfProjId2" type="cfId__Type"/>
        <xs:element name="cfProjId1" type="cfId__Type"/>
      </xs:choice>
      <xs:group ref="cfCoreClassWithFraction__Group"/>
    </xs:sequence>
  </xs:complexType>
</xs:element>
<xs:element name="cfProj_ResPubl">
  <xs:complexType>
    <xs:sequence>
      <xs:element name="cfResPublId" type="cfId__Type"/>
      <xs:group ref="cfCoreClassWithFraction__Group"/>
      <xs:element name="cfCopyright" type="xs:string" minOccurs="0"/>
    </xs:sequence>
  </xs:complexType>
</xs:element>
<xs:element name="cfProj_DC">
  <xs:complexType>
    <xs:sequence>
      <xs:sequence>
        <xs:element name="cfDCId" type="xs:string"/>
        <xs:element name="cfDCScheme" type="xs:string"/>
      </xs:sequence>
      <xs:group ref="cfCoreClassWithFraction__Group"/>
    </xs:sequence>
  </xs:complexType>

```

	<pre> </xs:element> <xs:element name="cfProj_Meas"> <xs:complexType> <xs:sequence> <xs:element name="cfMeasId" type="cfId__Type"/> <xs:group ref="cfCoreClassWithFraction__Group"/> </xs:sequence> </xs:complexType> </xs:element> <xs:element name="cfProj_Indic"> <xs:complexType> <xs:sequence> <xs:element name="cfIndicId" type="cfId__Type"/> <xs:group ref="cfCoreClassWithFraction__Group"/> </xs:sequence> </xs:complexType> </xs:element> <!-- embedded federated identifiers --> <xs:element name="cfFedId" type="cfFedId__EmbType"/> </xs:choice> </xs:sequence> </xs:complexType> </pre>
--	---

element **cfProj__Type/cfProjId**

diagram	
namespace	urn:xmlns:org:eurocris:cerif-1.6-2
type	cfId__Type
properties	isRef 0 content simple
facets	Kind Value annotation maxLength 128
source	<pre><xs:element name="cfProjId" type="cfId__Type"/></pre>

element **cfProj__Type/cfStartDate**

diagram	
namespace	urn:xmlns:org:eurocris:cerif-1.6-2
type	xs:date
properties	isRef 0 minOcc 0 maxOcc 1 content simple
source	<pre><xs:element name="cfStartDate" type="xs:date" minOccurs="0"/></pre>

element **cfProj__Type/cfEndDate**

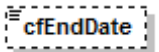
diagram	
namespace	urn:xmlns:org:eurocris:cerif-1.6-2
type	xs:date
properties	isRef 0 minOcc 0 maxOcc 1 content simple
source	<pre><xs:element name="cfEndDate" type="xs:date" minOccurs="0"/></pre>

element **cfProj_Type/cfAcro**

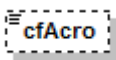
diagram	
namespace	urn:xmlns:org:eurocris:cerif-1.6-2
type	xs:string
properties	isRef 0 minOcc 0 maxOcc 1 content simple
source	<code><xs:element name="cfAcro" type="xs:string" minOccurs="0"/></code>

element **cfProj_Type/cfURI**

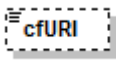
diagram	
namespace	urn:xmlns:org:eurocris:cerif-1.6-2
type	xs:string
properties	isRef 0 minOcc 0 maxOcc 1 content simple
source	<code><xs:element name="cfURI" type="xs:string" minOccurs="0"/></code>

element **cfProj_Type/cfTitle**

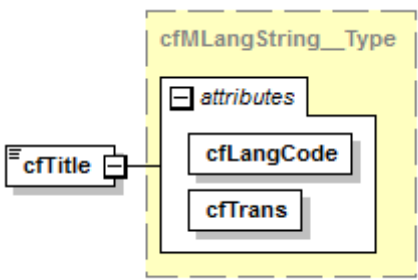
diagram																			
namespace	urn:xmlns:org:eurocris:cerif-1.6-2																		
type	cfMLangString_Type																		
properties	isRef 0 content complex																		
attributes	<table border="1"> <thead> <tr> <th>Name</th> <th>Type</th> <th>Use</th> <th>Default</th> <th>Fixed</th> <th>annotation</th> </tr> </thead> <tbody> <tr> <td>cfLangCode</td> <td>xs:string</td> <td>required</td> <td></td> <td></td> <td></td> </tr> <tr> <td>cfTrans</td> <td>cfTrans_Type</td> <td>required</td> <td></td> <td></td> <td></td> </tr> </tbody> </table>	Name	Type	Use	Default	Fixed	annotation	cfLangCode	xs:string	required				cfTrans	cfTrans_Type	required			
Name	Type	Use	Default	Fixed	annotation														
cfLangCode	xs:string	required																	
cfTrans	cfTrans_Type	required																	
source	<code><xs:element name="cfTitle" type="cfMLangString_Type"/></code>																		

element **cfProj_Type/cfAbstr**

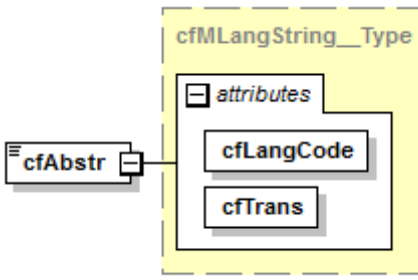
diagram	
namespace	urn:xmlns:org:eurocris:cerif-1.6-2

type	cfMLangString__Type					
properties	isRef	0	content	complex		
attributes	Name	Type	Use	Default	Fixed	annotation
	cfLangCode	xs:string	required			
	cfTrans	cfTrans__Type	required			
source	<xs:element name="cfAbstr" type="cfMLangString__Type"/>					

element **cfProj__Type/cfKeyw**

diagram						
namespace	urn:xmlns:org:eurocris:cerif-1.6-2					
type	cfMLangString__Type					
properties	isRef	0	content	complex		
attributes	Name	Type	Use	Default	Fixed	annotation
	cfLangCode	xs:string	required			
	cfTrans	cfTrans__Type	required			
source	<xs:element name="cfKeyw" type="cfMLangString__Type"/>					

element **cfProj__Type/cfProj_Class**

diagram						
namespace	urn:xmlns:org:eurocris:cerif-1.6-2					
type	cfCoreClassWithFraction__Type					
properties	isRef	0	content	complex		
children	cfClassId cfClassSchemeld cfStartDate cfEndDate cfFraction					
source	<xs:element name="cfProj_Class" type="cfCoreClassWithFraction__Type"/>					

element **cfProj_Type/cfProj_Event**

diagram	
namespace	urn:xmlns:org:eurocris:cerif-1.6-2
properties	isRef 0 content complex
children	cfEventId cfClassId cfClassSchemeld cfStartDate cfEndDate cfFraction
source	<pre> <xs:element name="cfProj_Event"> <xs:complexType> <xs:sequence> <xs:element name="cfEventId" type="cflD__Type"/> <xs:group ref="cfCoreClassWithFraction__Group"/> </xs:sequence> </xs:complexType> </xs:element> </pre>

element **cfProj_Type/cfProj_Event/cfEventId**

diagram	
namespace	urn:xmlns:org:eurocris:cerif-1.6-2
type	cflD__Type
properties	isRef 0 content simple
facets	Kind Value annotation maxLength 128
source	<pre> <xs:element name="cfEventId" type="cflD__Type"/> </pre>

element **cfProj_Type/cfProj_Fund**

diagram	
namespace	urn:xmlns:org:eurocris:cerif-1.6-2
properties	isRef 0 content complex
children	cfFundId cfClassId cfClassSchemeld cfStartDate cfEndDate cfFraction cfAmount
source	<pre> <xs:element name="cfProj_Fund"> <xs:complexType> <xs:sequence> <xs:element name="cfFundId" type="cflD__Type"/> </xs:sequence> </xs:complexType> </xs:element> </pre>

	<pre><xs:group ref="cfCoreClassWithFraction_Group"/> <xs:element name="cfAmount" type="cfAmount_Type" minOccurs="0"/> </xs:sequence> </xs:complexType> </xs:element></pre>
--	--

element cfProj_Type/cfProj_Fund/cfFundId

diagram	
namespace	urn:xmlns:org:eurocris:cerif-1.6-2
type	cfId_Type
properties	isRef 0 content simple
facets	Kind Value annotation maxLength 128
source	<pre><xs:element name="cfFundId" type="cfId_Type"/></pre>

element cfProj_Type/cfProj_Fund/cfAmount

diagram													
namespace	urn:xmlns:org:eurocris:cerif-1.6-2												
type	cfAmount_Type												
properties	isRef 0 minOcc 0 maxOcc 1 content complex												
attributes	<table border="1"> <thead> <tr> <th>Name</th> <th>Type</th> <th>Use</th> <th>Default</th> <th>Fixed</th> <th>annotation</th> </tr> </thead> <tbody> <tr> <td>cfCurrCode</td> <td>xs:string</td> <td>required</td> <td></td> <td></td> <td></td> </tr> </tbody> </table>	Name	Type	Use	Default	Fixed	annotation	cfCurrCode	xs:string	required			
Name	Type	Use	Default	Fixed	annotation								
cfCurrCode	xs:string	required											
source	<pre><xs:element name="cfAmount" type="cfAmount_Type" minOccurs="0"/></pre>												

element cfProj_Type/cfProj_OrgUnit

diagram	
namespace	urn:xmlns:org:eurocris:cerif-1.6-2
properties	isRef 0 content complex
children	cfOrgUnitId cfClassId cfClassSchemeld cfStartDate cfEndDate cfFraction
source	<pre><xs:element name="cfProj_OrgUnit"> <xs:complexType> <xs:sequence> <xs:element name="cfOrgUnitId" type="cfId_Type"/></pre>

	<pre><xs:group ref="cfCoreClassWithFraction__Group"/> </xs:sequence> </xs:complexType> </xs:element></pre>
--	--

element cfProj_Type/cfProj_OrgUnit/cfOrgUnitId

diagram	
namespace	urn:xmlns:org:eurocris:cerif-1.6-2
type	cfId_Type
properties	isRef 0 content simple
facets	Kind Value annotation maxLength 128
source	<pre><xs:element name="cfOrgUnitId" type="cfId_Type"/></pre>

element cfProj_Type/cfProj_Pers

diagram	
namespace	urn:xmlns:org:eurocris:cerif-1.6-2
properties	isRef 0 content complex
children	cfPersId cfClassId cfClassSchemeld cfStartDate cfEndDate cfFraction
source	<pre><xs:element name="cfProj_Pers"> <xs:complexType> <xs:sequence> <xs:element name="cfPersId" type="cfId_Type"/> <xs:group ref="cfCoreClassWithFraction__Group"/> </xs:sequence> </xs:complexType> </xs:element></pre>

element cfProj_Type/cfProj_Pers/cfPersId

diagram	
namespace	urn:xmlns:org:eurocris:cerif-1.6-2
type	cfId_Type
properties	isRef 0 content simple
facets	Kind Value annotation maxLength 128
source	<pre><xs:element name="cfPersId" type="cfId_Type"/></pre>

element **cfProj_Type/cfProj_Proj**

diagram	
namespace	urn.xmlns:org:eurocris:cerif-1.6-2
properties	isRef 0 content complex
children	cfProjId2 cfProjId1 cfClassId cfClassSchemeld cfStartDate cfEndDate cfFraction
source	<pre> <xs:element name="cfProj_Proj"> <xs:complexType> <xs:sequence> <xs:choice> <xs:element name="cfProjId2" type="cflD__Type"/> <xs:element name="cfProjId1" type="cflD__Type"/> </xs:choice> <xs:group ref="cfCoreClassWithFraction__Group"/> </xs:sequence> </xs:complexType> </xs:element> </pre>

element **cfProj_Type/cfProj_Proj/cfProjId2**

diagram	
namespace	urn.xmlns:org:eurocris:cerif-1.6-2
type	cflD_Type
properties	isRef 0 content simple
facets	Kind Value annotation maxLength 128
source	<pre><xs:element name="cfProjId2" type="cflD__Type"/></pre>

element **cfProj_Type/cfProj_Proj/cfProjId1**

diagram	
namespace	urn.xmlns:org:eurocris:cerif-1.6-2
type	cflD_Type
properties	isRef 0 content simple
facets	Kind Value annotation maxLength 128
source	<pre><xs:element name="cfProjId1" type="cflD__Type"/></pre>

element cfProj_Type/cfProj_ResPubl

diagram	
namespace	urn:xmlns:org:eurocris:cerif-1.6-2
properties	isRef 0 content complex
children	cfResPublId cfClassId cfClassSchemeld cfStartDate cfEndDate cfFraction cfCopyright
source	<pre> <xs:element name="cfProj_ResPubl"> <xs:complexType> <xs:sequence> <xs:element name="cfResPublId" type="cflD__Type"/> <xs:group ref="cfCoreClassWithFraction__Group"/> <xs:element name="cfCopyright" type="xs:string" minOccurs="0"/> </xs:sequence> </xs:complexType> </xs:element> </pre>

element cfProj_Type/cfProj_ResPubl/cfResPublId

diagram							
namespace	urn:xmlns:org:eurocris:cerif-1.6-2						
type	cflD__Type						
properties	isRef 0 content simple						
facets	<table border="1"> <thead> <tr> <th>Kind</th> <th>Value</th> <th>annotation</th> </tr> </thead> <tbody> <tr> <td>maxLength</td> <td>128</td> <td></td> </tr> </tbody> </table>	Kind	Value	annotation	maxLength	128	
Kind	Value	annotation					
maxLength	128						
source	<pre><xs:element name="cfResPublId" type="cflD__Type"/></pre>						

element cfProj_Type/cfProj_ResPubl/cfCopyright

diagram	
namespace	urn:xmlns:org:eurocris:cerif-1.6-2
type	xs:string
properties	isRef 0 minOcc 0 maxOcc 1 content simple
source	<pre><xs:element name="cfCopyright" type="xs:string" minOccurs="0"/></pre>

element **cfProj_Type/cfProj_DC**

diagram	
namespace	urn.xmlns:org:eurocris:cerif-1.6-2
properties	isRef 0 content complex
children	cfDCId cfDCScheme cfClassId cfClassSchemeId cfStartDate cfEndDate cfFraction
source	<pre> <xs:element name="cfProj_DC"> <xs:complexType> <xs:sequence> <xs:sequence> <xs:element name="cfDCId" type="xs:string"/> <xs:element name="cfDCScheme" type="xs:string"/> </xs:sequence> <xs:group ref="cfCoreClassWithFraction__Group"/> </xs:sequence> </xs:complexType> </xs:element> </pre>

element **cfProj_Type/cfProj_DC/cfDCId**

diagram	
namespace	urn.xmlns:org:eurocris:cerif-1.6-2
type	xs:string
properties	isRef 0 content simple
source	<pre><xs:element name="cfDCId" type="xs:string"/></pre>

element **cfProj_Type/cfProj_DC/cfDCScheme**

diagram	
namespace	urn.xmlns:org:eurocris:cerif-1.6-2
type	xs:string
properties	isRef 0 content simple
source	<pre><xs:element name="cfDCScheme" type="xs:string"/></pre>

element cfProj_Type/cfProj_Meas

diagram	
namespace	urn:xmlns:org:eurocris:cerif-1.6-2
properties	isRef 0 content complex
children	cfMeasId cfClassId cfClassSchemeld cfStartDate cfEndDate cfFraction
source	<pre> <xs:element name="cfProj_Meas"> <xs:complexType> <xs:sequence> <xs:element name="cfMeasId" type="cflD__Type"/> <xs:group ref="cfCoreClassWithFraction__Group"/> </xs:sequence> </xs:complexType> </xs:element> </pre>

element cfProj_Type/cfProj_Meas/cfMeasId

diagram	
namespace	urn:xmlns:org:eurocris:cerif-1.6-2
type	cflD__Type
properties	isRef 0 content simple
facets	Kind Value annotation maxLength 128
source	<pre> <xs:element name="cfMeasId" type="cflD__Type"/> </pre>

element cfProj_Type/cfProj_Indic

diagram	
namespace	urn:xmlns:org:eurocris:cerif-1.6-2
properties	isRef 0 content complex
children	cfIndicId cfClassId cfClassSchemeld cfStartDate cfEndDate cfFraction
source	<pre> <xs:element name="cfProj_Indic"> <xs:complexType> <xs:sequence> <xs:element name="cfIndicId" type="cflD__Type"/> <xs:group ref="cfCoreClassWithFraction__Group"/> </xs:sequence> </xs:complexType> </xs:element> </pre>

	<pre></xs:complexType> </xs:element></pre>
--	--

element **cfProj__Type/cfProj_Indic/cfIndicId**

diagram	
namespace	urn:xmlns:org:eurocris:cerif-1.6-2
type	cfd_Type
properties	isRef 0 content simple
facets	Kind Value annotation maxLength 128
source	<pre><xs:element name="cfIndicId" type="cfd_Type"/></pre>

element **cfProj__Type/cfFedId**

diagram	
namespace	urn:xmlns:org:eurocris:cerif-1.6-2
type	cfFedId_EmbType
properties	isRef 0 content complex
children	cfFedIdId cfFedId cfClassId cfClassSchemeld cfStartDate cfEndDate cfFedId_Class
source	<pre><xs:element name="cfFedId" type="cfFedId__EmbType"/></pre>

complexType **cfProj_Class__Type**

diagram	
namespace	urn:xmlns:org:eurocris:cerif-1.6-2
children	cfProjId cfClassId cfClassSchemeld cfStartDate cfEndDate cfFraction

used by	element CERIF/cfProj_Class
source	<pre><xs:complexType name="cfProj_Class__Type"> <xs:sequence> <xs:element name="cfProjId" type="cfId__Type"/> <xs:group ref="cfCoreClassWithFraction__Group"/> </xs:sequence> </xs:complexType></pre>

element cfProj_Class__Type/cfProjId

diagram	
namespace	urn:xmlns:org:eurocris:cerif-1.6-2
type	cfId__Type
properties	isRef 0 content simple
facets	Kind Value annotation maxLength 128
source	<pre><xs:element name="cfProjId" type="cfId__Type"/></pre>

complexType cfProj_DC__Type

diagram	
namespace	urn:xmlns:org:eurocris:cerif-1.6-2
children	cfDCId cfDCScheme cfProjId cfClassId cfClassSchemeId cfStartDate cfEndDate cfFraction
used by	element CERIF/cfProj_DC
source	<pre><xs:complexType name="cfProj_DC__Type"> <xs:sequence> <xs:element name="cfDCId" type="xs:string"/> <xs:element name="cfDCScheme" type="xs:string"/> <xs:element name="cfProjId" type="cfId__Type"/> <xs:group ref="cfCoreClassWithFraction__Group"/> </xs:sequence> </xs:complexType></pre>

element cfProj_DC__Type/cfDCId

diagram	
namespace	urn:xmlns:org:eurocris:cerif-1.6-2
type	xs:string
properties	isRef 0 content simple
source	<pre><xs:element name="cfDCId" type="xs:string"/></pre>

element **cfProj_DC_Type/cfDCScheme**

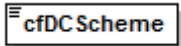
diagram	
namespace	urn:xmlns:org:eurocris:cerif-1.6-2
type	xs:string
properties	isRef 0 content simple
source	<code><xs:element name="cfDCScheme" type="xs:string"/></code>

element **cfProj_DC_Type/cfProjId**

diagram	
namespace	urn:xmlns:org:eurocris:cerif-1.6-2
type	cfld_Type
properties	isRef 0 content simple
facets	Kind Value annotation maxLength 128
source	<code><xs:element name="cfProjId" type="cfld_Type"/></code>

complexType **cfProj_Event_Type**

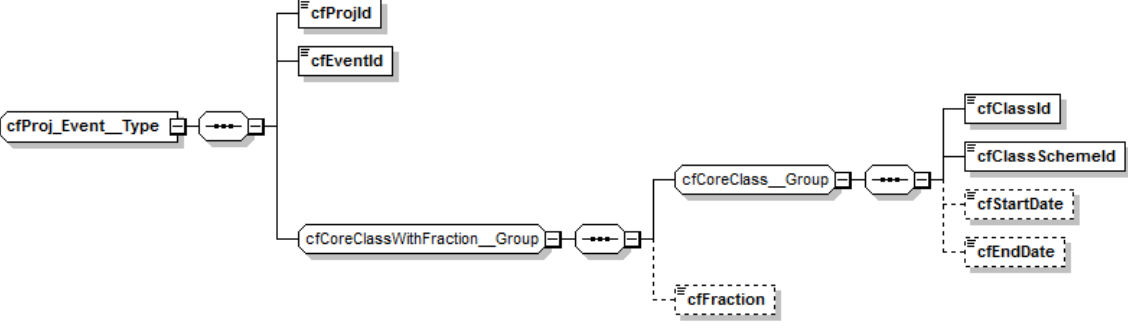
diagram	
namespace	urn:xmlns:org:eurocris:cerif-1.6-2
children	cfProjId cfEventId cfClassId cfClassSchemeId cfStartDate cfEndDate cfFraction
used by	element CERIF/cfProj_Event
source	<pre><xs:complexType name="cfProj_Event_Type"> <xs:sequence> <xs:element name="cfProjId" type="cfld_Type"/> <xs:element name="cfEventId" type="cfld_Type"/> <xs:group ref="cfCoreClassWithFraction_Group"/> </xs:sequence> </xs:complexType></pre>

element **cfProj_Event_Type/cfProjId**

diagram	
namespace	urn:xmlns:org:eurocris:cerif-1.6-2
type	cfld_Type
properties	isRef 0 content simple
facets	Kind Value annotation maxLength 128

source	<xs:element name="cfProjId" type="cfId__Type"/>
--------	---

element cfProj_Event_Type/cfEventId

diagram	
namespace	urn:xmlns:org:eurocris:cerif-1.6-2
type	cfId__Type
properties	isRef 0 content simple
facets	Kind Value annotation maxLength 128
source	<xs:element name="cfEventId" type="cfId__Type"/>

complexType cfProj_Fund_Type

diagram	
namespace	urn:xmlns:org:eurocris:cerif-1.6-2
children	cfProjId cfFundId cfClassId cfClassSchemeld cfStartDate cfEndDate cfFraction cfAmount
used by	element CERIF/cfProj_Fund
source	<pre> <xs:complexType name="cfProj_Fund__Type"> <xs:sequence> <xs:element name="cfProjId" type="cfId__Type"/> <xs:element name="cfFundId" type="cfId__Type"/> <xs:group ref="cfCoreClassWithFraction__Group"/> <xs:element name="cfAmount" type="cfAmount__Type" minOccurs="0"/> </xs:sequence> </xs:complexType> </pre>

element cfProj_Fund_Type/cfProjId

diagram	
namespace	urn:xmlns:org:eurocris:cerif-1.6-2
type	cfId__Type
properties	isRef 0 content simple
facets	Kind Value annotation maxLength 128
source	<xs:element name="cfProjId" type="cfId__Type"/>

element **cfProj_Fund__Type/cfFundId**

diagram	
namespace	urn:xmlns:org:eurocris:cerif-1.6-2
type	cfId__Type
properties	isRef 0 content simple
facets	Kind Value annotation maxLength 128
source	<code><xs:element name="cfFundId" type="cfId__Type"/></code>

element **cfProj_Fund__Type/cfAmount**

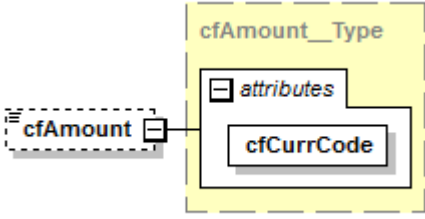
diagram													
namespace	urn:xmlns:org:eurocris:cerif-1.6-2												
type	cfAmount__Type												
properties	isRef 0 minOcc 0 maxOcc 1 content complex												
attributes	<table border="1"> <thead> <tr> <th>Name</th> <th>Type</th> <th>Use</th> <th>Default</th> <th>Fixed</th> <th>annotation</th> </tr> </thead> <tbody> <tr> <td>cfCurrCode</td> <td>xs:string</td> <td>required</td> <td></td> <td></td> <td></td> </tr> </tbody> </table>	Name	Type	Use	Default	Fixed	annotation	cfCurrCode	xs:string	required			
Name	Type	Use	Default	Fixed	annotation								
cfCurrCode	xs:string	required											
source	<code><xs:element name="cfAmount" type="cfAmount__Type" minOccurs="0"/></code>												

complexType **cfProj_Indic__Type**

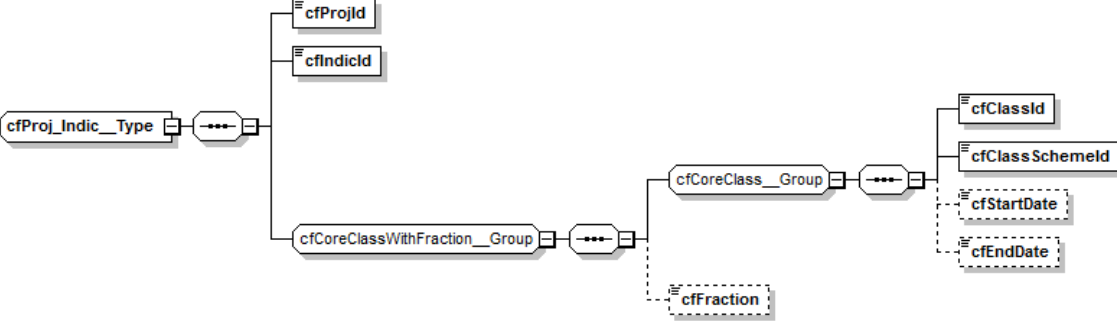
diagram	
namespace	urn:xmlns:org:eurocris:cerif-1.6-2
children	cfProjId cfIndicId cfClassId cfClassSchemeId cfStartDate cfEndDate cfFraction
used by	element CERIF/cfProj_Indic
source	<pre> <xs:complexType name="cfProj_Indic__Type"> <xs:sequence> <xs:element name="cfProjId" type="cfId__Type"/> <xs:element name="cfIndicId" type="cfId__Type"/> <xs:group ref="cfCoreClassWithFraction__Group"/> </xs:sequence> </xs:complexType> </pre>

element **cfProj_Indic__Type/cfProjId**

diagram	
namespace	urn:xmlns:org:eurocris:cerif-1.6-2
type	cflD_Type
properties	isRef 0 content simple
facets	Kind Value annotation maxLength 128
source	<code><xs:element name="cfProjId" type="cflD_Type"/></code>

element **cfProj_Indic__Type/cfIndicId**

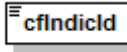
diagram	
namespace	urn:xmlns:org:eurocris:cerif-1.6-2
type	cflD_Type
properties	isRef 0 content simple
facets	Kind Value annotation maxLength 128
source	<code><xs:element name="cfIndicId" type="cflD_Type"/></code>

complexType **cfProj_Meas__Type**

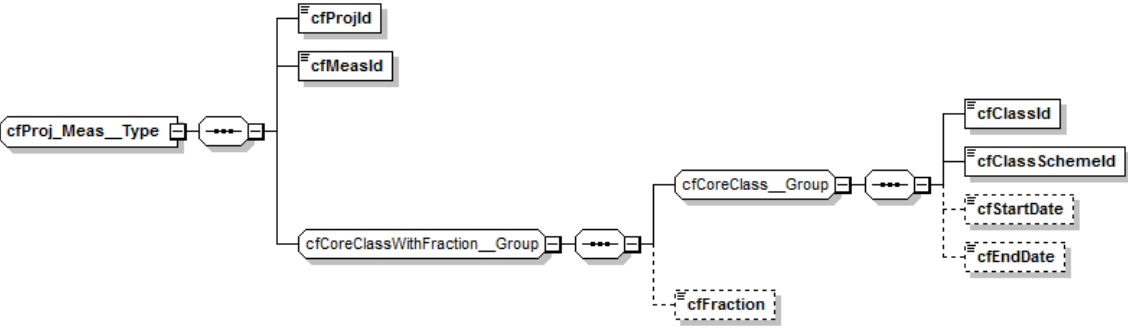
diagram	
namespace	urn:xmlns:org:eurocris:cerif-1.6-2
children	cfProjId cfMeasId cfClassId cfClassSchemeld cfStartDate cfEndDate cfFraction
used by	element CERIF/cfProj_Meas
source	<pre><xs:complexType name="cfProj_Meas__Type"> <xs:sequence> <xs:element name="cfProjId" type="cflD_Type"/> <xs:element name="cfMeasId" type="cflD_Type"/> <xs:group ref="cfCoreClassWithFraction__Group"/> </xs:sequence> </xs:complexType></pre>

element **cfProj_Meas__Type/cfProjId**

diagram	
namespace	urn:xmlns:org:eurocris:cerif-1.6-2
type	cflD_Type
properties	isRef 0 content simple

facets	Kind maxLength	Value 128	annotation
source	<xs:element name="cfProjId" type="cFld__Type"/>		

element cfProj_Meas__Type/cfMeasId

diagram			
namespace	urn:xmlns:org:eurocris:cerif-1.6-2		
type	cFld__Type		
properties	isRef	0	content simple
facets	Kind maxLength	Value 128	annotation
source	<xs:element name="cfMeasId" type="cFld__Type"/>		

complexType cfProj_OrgUnit__Type

diagram			
namespace	urn:xmlns:org:eurocris:cerif-1.6-2		
children	cfProjId cfOrgUnitId cfClassId cfClassSchemeld cfStartDate cfEndDate cfFraction		
used by	element	CERIF/cfProj_OrgUnit	
source	<pre><xs:complexType name="cfProj_OrgUnit__Type"> <xs:sequence> <xs:element name="cfProjId" type="cFld__Type"/> <xs:element name="cfOrgUnitId" type="cFld__Type"/> <xs:group ref="cfCoreClassWithFraction__Group"/> </xs:sequence> </xs:complexType></pre>		

element cfProj_OrgUnit__Type/cfProjId

diagram			
namespace	urn:xmlns:org:eurocris:cerif-1.6-2		
type	cFld__Type		
properties	isRef	0	content simple
facets	Kind maxLength	Value 128	annotation
source	<xs:element name="cfProjId" type="cFld__Type"/>		

element **cfProj_OrgUnit_Type/cfOrgUnitId**

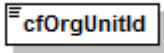
diagram	
namespace	urn:xmlns:org:eurocris:cerif-1.6-2
type	cfdl_Type
properties	isRef 0 content simple
facets	Kind Value annotation maxLength 128
source	<code><xs:element name="cfOrgUnitId" type="cfdl_Type"/></code>

complexType **cfProj_Pers_Type**

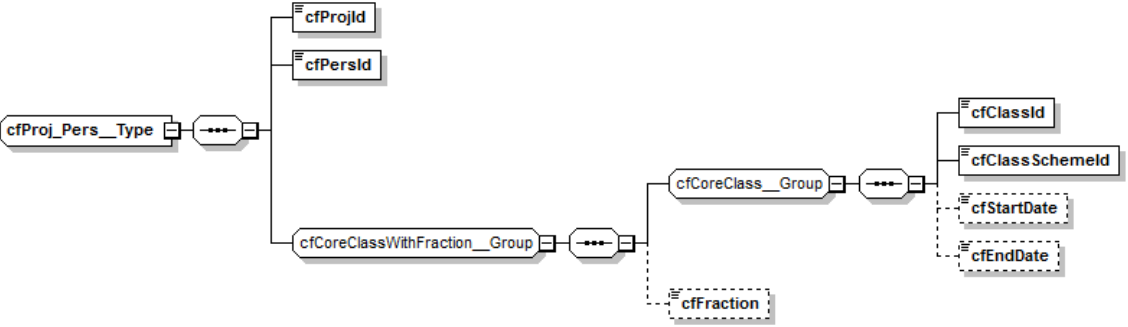
diagram	
namespace	urn:xmlns:org:eurocris:cerif-1.6-2
children	cfProjId cfPersId cfClassId cfClassSchemeld cfStartDate cfEndDate cfFraction
used by	element CERIF/cfProj_Pers
source	<pre><xs:complexType name="cfProj_Pers_Type"> <xs:sequence> <xs:element name="cfProjId" type="cfdl_Type"/> <xs:element name="cfPersId" type="cfdl_Type"/> <xs:group ref="cfCoreClassWithFraction_Group"/> </xs:sequence> </xs:complexType></pre>

element **cfProj_Pers_Type/cfProjId**

diagram	
namespace	urn:xmlns:org:eurocris:cerif-1.6-2
type	cfdl_Type
properties	isRef 0 content simple
facets	Kind Value annotation maxLength 128
source	<code><xs:element name="cfProjId" type="cfdl_Type"/></code>

element **cfProj_Pers_Type/cfPersId**

diagram	
namespace	urn:xmlns:org:eurocris:cerif-1.6-2
type	cfdl_Type
properties	isRef 0 content simple

facets	Kind maxLength	Value 128	annotation
source	<xs:element name="cfPersId" type="cFld__Type"/>		

complexType cfProj_Proj_Type

diagram	
namespace	urn:xmlns:org:eurocris:cerif-1.6-2
children	cfProjId1 cfProjId2 cfClassId cfClassSchemeld cfStartDate cfEndDate cfFraction
used by	element CERIF/cfProj_Proj
source	<pre><xs:complexType name="cfProj_Proj_Type"> <xs:sequence> <xs:element name="cfProjId1" type="cFld__Type"/> <xs:element name="cfProjId2" type="cFld__Type"/> <xs:group ref="cfCoreClassWithFraction_Group"/> </xs:sequence> </xs:complexType></pre>

element cfProj_Proj_Type/cfProjId1

diagram			
namespace	urn:xmlns:org:eurocris:cerif-1.6-2		
type	cFld__Type		
properties	isRef 0 content simple		
facets	Kind maxLength	Value 128	annotation
source	<xs:element name="cfProjId1" type="cFld__Type"/>		

element cfProj_Proj_Type/cfProjId2

diagram			
namespace	urn:xmlns:org:eurocris:cerif-1.6-2		
type	cFld__Type		
properties	isRef 0 content simple		
facets	Kind maxLength	Value 128	annotation
source	<xs:element name="cfProjId2" type="cFld__Type"/>		

complexType **cfProj_ResPubl_Type**

diagram	
namespace	urn:xmlns:org:eurocris:cerif-1.6-2
children	cfProjId cfResPublId cfClassId cfClassSchemeld cfStartDate cfEndDate cfFraction cfCopyright
used by	element CERIF/cfProj_ResPubl
source	<pre> <xs:complexType name="cfProj_ResPubl_Type"> <xs:sequence> <xs:element name="cfProjId" type="cflD__Type"/> <xs:element name="cfResPublId" type="cflD__Type"/> <xs:group ref="cfCoreClassWithFraction_Group"/> <xs:element name="cfCopyright" type="xs:string" minOccurs="0"/> </xs:sequence> </xs:complexType> </pre>

element **cfProj_ResPubl_Type/cfProjId**

diagram	
namespace	urn:xmlns:org:eurocris:cerif-1.6-2
type	cflD__Type
properties	isRef 0 content simple
facets	Kind Value annotation maxLength 128
source	<pre><xs:element name="cfProjId" type="cflD__Type"/></pre>

element **cfProj_ResPubl_Type/cfResPublId**

diagram	
namespace	urn:xmlns:org:eurocris:cerif-1.6-2
type	cflD__Type
properties	isRef 0 content simple
facets	Kind Value annotation maxLength 128
source	<pre><xs:element name="cfResPublId" type="cflD__Type"/></pre>

element **cfProj_ResPubl_Type/cfCopyright**

diagram	
namespace	urn:xmlns:org:eurocris:cerif-1.6-2
type	xs:string

properties	isRef 0 minOcc 0 maxOcc 1 content simple
source	<xs:element name="cfCopyright" type="xs:string" minOccurs="0"/>

complexType cfProjAbstr__Type

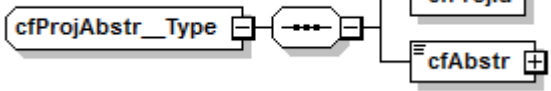
diagram	
namespace	urn:xmlns:org:eurocris:cerif-1.6-2
children	cfProjId cfAbstr
used by	element CERIF/cfProjAbstr
source	<xs:complexType name="cfProjAbstr__Type"> <xs:sequence> <xs:element name="cfProjId" type="cfId__Type"/> <xs:element name="cfAbstr" type="cfMLangString__Type"/> </xs:sequence> </xs:complexType>

element cfProjAbstr__Type/cfProjId

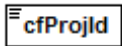
diagram	
namespace	urn:xmlns:org:eurocris:cerif-1.6-2
type	cfId__Type
properties	isRef 0 content simple
facets	Kind Value annotation maxLength 128
source	<xs:element name="cfProjId" type="cfId__Type"/>

element cfProjAbstr__Type/cfAbstr

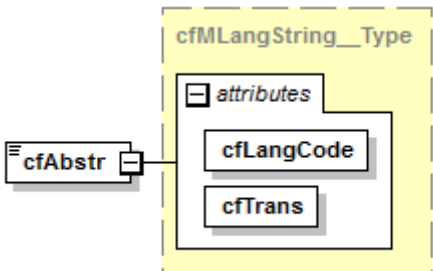
diagram																			
namespace	urn:xmlns:org:eurocris:cerif-1.6-2																		
type	cfMLangString__Type																		
properties	isRef 0 content complex																		
attributes	<table border="1"> <thead> <tr> <th>Name</th> <th>Type</th> <th>Use</th> <th>Default</th> <th>Fixed</th> <th>annotation</th> </tr> </thead> <tbody> <tr> <td>cfLangCode</td> <td>xs:string</td> <td>required</td> <td></td> <td></td> <td></td> </tr> <tr> <td>cfTrans</td> <td>cfTrans__Type</td> <td>required</td> <td></td> <td></td> <td></td> </tr> </tbody> </table>	Name	Type	Use	Default	Fixed	annotation	cfLangCode	xs:string	required				cfTrans	cfTrans__Type	required			
Name	Type	Use	Default	Fixed	annotation														
cfLangCode	xs:string	required																	
cfTrans	cfTrans__Type	required																	
source	<xs:element name="cfAbstr" type="cfMLangString__Type"/>																		

complexType cfProjKeyw__Type

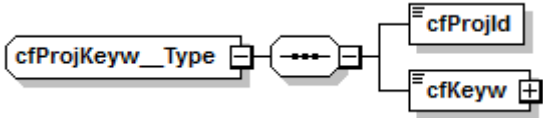
diagram	
namespace	urn:xmlns:org:eurocris:cerif-1.6-2
children	cfProjId cfKeyw
used by	element CERIF/cfProjKeyw
source	<pre><xs:complexType name="cfProjKeyw__Type"> <xs:sequence> <xs:element name="cfProjId" type="cfId__Type"/> <xs:element name="cfKeyw" type="cfMLangString__Type"/> </xs:sequence> </xs:complexType></pre>

element cfProjKeyw__Type/cfProjId

diagram	
namespace	urn:xmlns:org:eurocris:cerif-1.6-2
type	cfId__Type
properties	isRef 0 content simple
facets	Kind Value annotation maxLength 128
source	<pre><xs:element name="cfProjId" type="cfId__Type"/></pre>

element cfProjKeyw__Type/cfKeyw

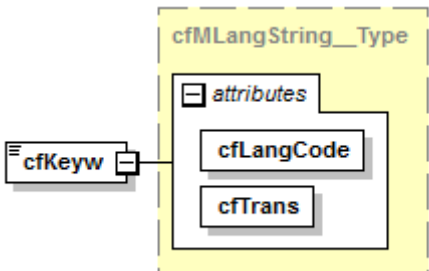
diagram																			
namespace	urn:xmlns:org:eurocris:cerif-1.6-2																		
type	cfMLangString__Type																		
properties	isRef 0 content complex																		
attributes	<table border="1"> <thead> <tr> <th>Name</th> <th>Type</th> <th>Use</th> <th>Default</th> <th>Fixed</th> <th>annotation</th> </tr> </thead> <tbody> <tr> <td>cfLangCode</td> <td>xs:string</td> <td>required</td> <td></td> <td></td> <td></td> </tr> <tr> <td>cfTrans</td> <td>cfTrans__Type</td> <td>required</td> <td></td> <td></td> <td></td> </tr> </tbody> </table>	Name	Type	Use	Default	Fixed	annotation	cfLangCode	xs:string	required				cfTrans	cfTrans__Type	required			
Name	Type	Use	Default	Fixed	annotation														
cfLangCode	xs:string	required																	
cfTrans	cfTrans__Type	required																	
source	<pre><xs:element name="cfKeyw" type="cfMLangString__Type"/></pre>																		

complexType cfProjTitle__Type

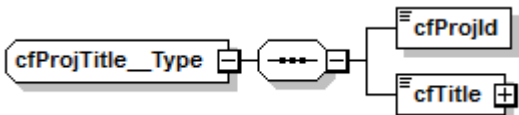
diagram	
namespace	urn:xmlns:org:eurocris:cerif-1.6-2

children	cfProjId cfTitle
used by	element CERIF/cfProjTitle
source	<pre><xs:complexType name="cfProjTitle__Type"> <xs:sequence> <xs:element name="cfProjId" type="cfId__Type"/> <xs:element name="cfTitle" type="cfMLangString__Type"/> </xs:sequence> </xs:complexType></pre>

element [cfProjTitle__Type/cfProjId](#)

diagram	 A diagram showing a box labeled 'cfProjId' with a small square icon to its left.
namespace	urn.xmlns.org:eurocris:cerif-1.6-2
type	cfId__Type
properties	isRef 0 content simple
facets	Kind Value annotation maxLength 128
source	<pre><xs:element name="cfProjId" type="cfId__Type"/></pre>

element [cfProjTitle__Type/cfTitle](#)

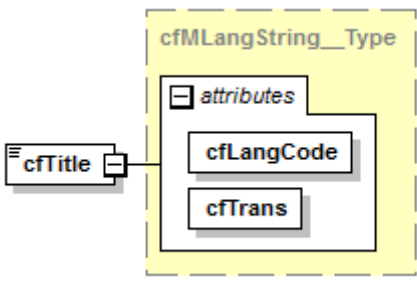
diagram	 A diagram showing a box labeled 'cfTitle' with a small square icon to its left. A line connects it to a larger box labeled 'cfMLangString__Type' which contains an 'attributes' box, a 'cfLangCode' box, and a 'cfTrans' box.																		
namespace	urn.xmlns.org:eurocris:cerif-1.6-2																		
type	cfMLangString__Type																		
properties	isRef 0 content complex																		
attributes	<table border="1"> <thead> <tr> <th>Name</th> <th>Type</th> <th>Use</th> <th>Default</th> <th>Fixed</th> <th>annotation</th> </tr> </thead> <tbody> <tr> <td>cfLangCode</td> <td>xs:string</td> <td>required</td> <td></td> <td></td> <td></td> </tr> <tr> <td>cfTrans</td> <td>cfTrans__Type</td> <td>required</td> <td></td> <td></td> <td></td> </tr> </tbody> </table>	Name	Type	Use	Default	Fixed	annotation	cfLangCode	xs:string	required				cfTrans	cfTrans__Type	required			
Name	Type	Use	Default	Fixed	annotation														
cfLangCode	xs:string	required																	
cfTrans	cfTrans__Type	required																	
source	<pre><xs:element name="cfTitle" type="cfMLangString__Type"/></pre>																		

complexType **cfQual__Type**

diagram	
namespace	urn:xmlns:org:eurocris:cerif-1.6-2
children	cfQualId cfURI cfDescr cfKeyw cfTitle cfPers_Qual cfQual_Class cfFedId
used by	element CERIF/cfQual
source	<pre> <xs:complexType name="cfQual__Type"> <xs:sequence> <xs:element name="cfQualId" type="cfId__Type"/> <xs:element name="cfURI" type="xs:string" minOccurs="0"/> <xs:choice minOccurs="0" maxOccurs="unbounded"> <!-- embedded multiple-language attributes --> <xs:element name="cfDescr" type="cfMLangString__Type"/> <xs:element name="cfKeyw" type="cfMLangString__Type"/> <xs:element name="cfTitle" type="cfMLangString__Type"/> <!-- embedded linking entities --> <xs:element name="cfPers_Qual"> <xs:complexType> <xs:sequence> <xs:element name="cfPersId" type="cfId__Type"/> <xs:group ref="cfCoreClassWithFraction__Group"/> </xs:sequence> </xs:complexType> </xs:element> <xs:element name="cfQual_Class" type="cfCoreClassWithFraction__Type"/> <!-- embedded federated identifiers --> <xs:element name="cfFedId" type="cfFedId__EmbType"/> </xs:choice> </xs:sequence> </xs:complexType> </pre>

element **cfQual__Type/cfQualId**

diagram	
namespace	urn:xmlns:org:eurocris:cerif-1.6-2
type	cfId__Type
properties	isRef 0 content simple
facets	Kind Value annotation maxLength 128
source	<pre><xs:element name="cfQualId" type="cfId__Type"/></pre>

element cfQual_Type/cfURI

diagram	
namespace	urn:xmlns:org:eurocris:cerif-1.6-2
type	xs:string
properties	isRef 0 minOcc 0 maxOcc 1 content simple
source	<code><xs:element name="cfURI" type="xs:string" minOccurs="0"/></code>

element cfQual_Type/cfDescr

diagram																			
namespace	urn:xmlns:org:eurocris:cerif-1.6-2																		
type	cfMLangString_Type																		
properties	isRef 0 content complex																		
attributes	<table border="1"> <thead> <tr> <th>Name</th> <th>Type</th> <th>Use</th> <th>Default</th> <th>Fixed</th> <th>annotation</th> </tr> </thead> <tbody> <tr> <td>cfLangCode</td> <td>xs:string</td> <td>required</td> <td></td> <td></td> <td></td> </tr> <tr> <td>cfTrans</td> <td>cfTrans_Type</td> <td>required</td> <td></td> <td></td> <td></td> </tr> </tbody> </table>	Name	Type	Use	Default	Fixed	annotation	cfLangCode	xs:string	required				cfTrans	cfTrans_Type	required			
Name	Type	Use	Default	Fixed	annotation														
cfLangCode	xs:string	required																	
cfTrans	cfTrans_Type	required																	
source	<code><xs:element name="cfDescr" type="cfMLangString_Type"/></code>																		

element cfQual_Type/cfKeyw

diagram																			
namespace	urn:xmlns:org:eurocris:cerif-1.6-2																		
type	cfMLangString_Type																		
properties	isRef 0 content complex																		
attributes	<table border="1"> <thead> <tr> <th>Name</th> <th>Type</th> <th>Use</th> <th>Default</th> <th>Fixed</th> <th>annotation</th> </tr> </thead> <tbody> <tr> <td>cfLangCode</td> <td>xs:string</td> <td>required</td> <td></td> <td></td> <td></td> </tr> <tr> <td>cfTrans</td> <td>cfTrans_Type</td> <td>required</td> <td></td> <td></td> <td></td> </tr> </tbody> </table>	Name	Type	Use	Default	Fixed	annotation	cfLangCode	xs:string	required				cfTrans	cfTrans_Type	required			
Name	Type	Use	Default	Fixed	annotation														
cfLangCode	xs:string	required																	
cfTrans	cfTrans_Type	required																	
source	<code><xs:element name="cfKeyw" type="cfMLangString_Type"/></code>																		

element cfQual__Type/cfTitle

diagram						
namespace	urn:xmlns:org:eurocris:cerif-1.6-2					
type	cfMLangString__Type					
properties	isRef	0	content	complex		
attributes	Name	Type	Use	Default	Fixed	annotation
	cfLangCode	xs:string	required			
	cfTrans	cfTrans__Type	required			
source	<code><xs:element name="cfTitle" type="cfMLangString__Type"/></code>					

element cfQual__Type/cfPers_Qual

diagram						
namespace	urn:xmlns:org:eurocris:cerif-1.6-2					
properties	isRef	0	content	complex		
children	cfPersId cfClassId cfClassSchemeld cfStartDate cfEndDate cfFraction					
source	<pre> <xs:element name="cfPers_Qual"> <xs:complexType> <xs:sequence> <xs:element name="cfPersId" type="cfId__Type"/> <xs:group ref="cfCoreClassWithFraction__Group"/> </xs:sequence> </xs:complexType> </xs:element> </pre>					

element cfQual__Type/cfPers_Qual/cfPersId

diagram						
namespace	urn:xmlns:org:eurocris:cerif-1.6-2					
type	cfId__Type					
properties	isRef	0	content	simple		
facets	Kind	Value	annotation			
	maxLength	128				
source	<code><xs:element name="cfPersId" type="cfId__Type"/></code>					

element cfQual__Type/cfQual_Class

diagram	
namespace	urn:xmlns:org:eurocris:cerif-1.6-2
type	cfCoreClassWithFraction__Type
properties	isRef 0 content complex
children	cfClassId cfClassSchemeld cfStartDate cfEndDate cfFraction
source	<xs:element name="cfQual_Class" type="cfCoreClassWithFraction__Type"/>

element cfQual__Type/cfFedId

diagram	
namespace	urn:xmlns:org:eurocris:cerif-1.6-2
type	cfFedId__EmbType
properties	isRef 0 content complex
children	cfFedIdId cfFedId cfClassId cfClassSchemeld cfStartDate cfEndDate cfFedId_Class
source	<xs:element name="cfFedId" type="cfFedId__EmbType"/>

complexType **cfQual_Class_Type**

diagram	
namespace	urn:xmlns:org:eurocris:cerif-1.6-2
children	cfQualId cfClassId cfClassSchemeld cfStartDate cfEndDate cfFraction
used by	element CERIF/cfQual_Class
source	<pre><xs:complexType name="cfQual_Class_Type"> <xs:sequence> <xs:element name="cfQualId" type="cflD__Type"/> <xs:group ref="cfCoreClassWithFraction_Group"/> </xs:sequence> </xs:complexType></pre>

element **cfQual_Class_Type/cfQualId**

diagram	
namespace	urn:xmlns:org:eurocris:cerif-1.6-2
type	cflD_Type
properties	isRef 0 content simple
facets	Kind Value annotation maxLength 128
source	<pre><xs:element name="cfQualId" type="cflD__Type"/></pre>

complexType **cfQualDescr_Type**

diagram	
namespace	urn:xmlns:org:eurocris:cerif-1.6-2
children	cfQualId cfDescr
used by	element CERIF/cfQualDescr
source	<pre><xs:complexType name="cfQualDescr_Type"> <xs:sequence> <xs:element name="cfQualId" type="cflD__Type"/> <xs:element name="cfDescr" type="cfMLangString__Type"/> </xs:sequence> </xs:complexType></pre>

element **cfQualDescr_Type/cfQualId**

diagram	
namespace	urn:xmlns:org:eurocris:cerif-1.6-2
type	cflD_Type

properties	isRef 0 content simple
facets	Kind Value annotation maxLength 128
source	<code><xs:element name="cfQualId" type="cflD__Type"/></code>

element **cfQualDescr__Type/cfDescr**

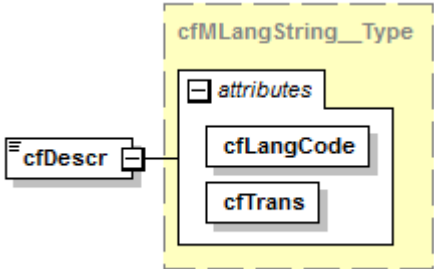
diagram																			
namespace	urn:xmlns:org:eurocris:cerif-1.6-2																		
type	cfMLangString__Type																		
properties	isRef 0 content complex																		
attributes	<table border="1"> <thead> <tr> <th>Name</th> <th>Type</th> <th>Use</th> <th>Default</th> <th>Fixed</th> <th>annotation</th> </tr> </thead> <tbody> <tr> <td>cfLangCode</td> <td>xs:string</td> <td>required</td> <td></td> <td></td> <td></td> </tr> <tr> <td>cfTrans</td> <td>cfTrans__Type</td> <td>required</td> <td></td> <td></td> <td></td> </tr> </tbody> </table>	Name	Type	Use	Default	Fixed	annotation	cfLangCode	xs:string	required				cfTrans	cfTrans__Type	required			
Name	Type	Use	Default	Fixed	annotation														
cfLangCode	xs:string	required																	
cfTrans	cfTrans__Type	required																	
source	<code><xs:element name="cfDescr" type="cfMLangString__Type"/></code>																		

complexType **cfQualKeyw__Type**

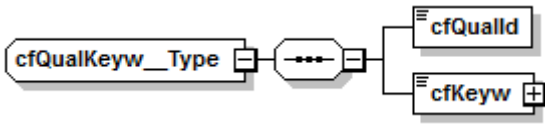
diagram	
namespace	urn:xmlns:org:eurocris:cerif-1.6-2
children	cfQualId cfKeyw
used by	element CERIF/cfQualKeyw
source	<pre> <xs:complexType name="cfQualKeyw__Type"> <xs:sequence> <xs:element name="cfQualId" type="cflD__Type"/> <xs:element name="cfKeyw" type="cfMLangString__Type"/> </xs:sequence> </xs:complexType> </pre>

element **cfQualKeyw__Type/cfQualId**

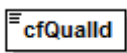
diagram	
namespace	urn:xmlns:org:eurocris:cerif-1.6-2
type	cflD__Type
properties	isRef 0 content simple
facets	Kind Value annotation maxLength 128
source	<code><xs:element name="cfQualId" type="cflD__Type"/></code>

element **cfQualKeyw__Type/cfKeyw**

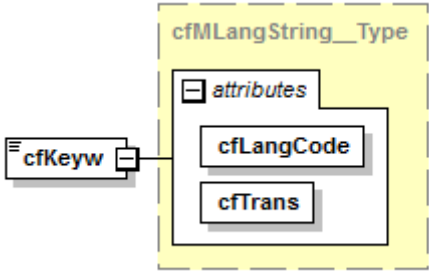
diagram																			
namespace	urn:xmlns:org:eurocris:cerif-1.6-2																		
type	cfMLangString__Type																		
properties	isRef 0 content complex																		
attributes	<table border="1"> <thead> <tr> <th>Name</th> <th>Type</th> <th>Use</th> <th>Default</th> <th>Fixed</th> <th>annotation</th> </tr> </thead> <tbody> <tr> <td>cfLangCode</td> <td>xs:string</td> <td>required</td> <td></td> <td></td> <td></td> </tr> <tr> <td>cfTrans</td> <td>cfTrans__Type</td> <td>required</td> <td></td> <td></td> <td></td> </tr> </tbody> </table>	Name	Type	Use	Default	Fixed	annotation	cfLangCode	xs:string	required				cfTrans	cfTrans__Type	required			
Name	Type	Use	Default	Fixed	annotation														
cfLangCode	xs:string	required																	
cfTrans	cfTrans__Type	required																	
source	<code><xs:element name="cfKeyw" type="cfMLangString__Type"/></code>																		

complexType **cfQualTitle__Type**

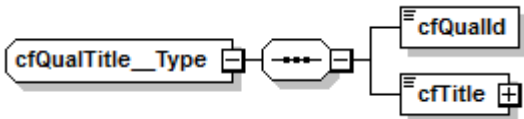
diagram	
namespace	urn:xmlns:org:eurocris:cerif-1.6-2
children	cfQualId cfTitle
used by	element CERIF/cfQualTitle
source	<code><xs:complexType name="cfQualTitle__Type"> <xs:sequence> <xs:element name="cfQualId" type="cfId__Type"/> <xs:element name="cfTitle" type="cfMLangString__Type"/> </xs:sequence> </xs:complexType></code>

element **cfQualTitle__Type/cfQualId**

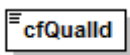
diagram							
namespace	urn:xmlns:org:eurocris:cerif-1.6-2						
type	cfId__Type						
properties	isRef 0 content simple						
facets	<table border="1"> <thead> <tr> <th>Kind</th> <th>Value</th> <th>annotation</th> </tr> </thead> <tbody> <tr> <td>maxLength</td> <td>128</td> <td></td> </tr> </tbody> </table>	Kind	Value	annotation	maxLength	128	
Kind	Value	annotation					
maxLength	128						
source	<code><xs:element name="cfQualId" type="cfId__Type"/></code>						

element **cfQualTitle__Type/cfTitle**

<p>diagram</p>	<pre> classDiagram class cfTitle class cfMLangString__Type { attributes cfLangCode cfTrans } cfTitle -- > cfMLangString__Type </pre>																		
<p>namespace</p>	<p>urn:xmlns:org:eurocris:cerif-1.6-2</p>																		
<p>type</p>	<p>cfMLangString__Type</p>																		
<p>properties</p>	<p>isRef 0 content complex</p>																		
<p>attributes</p>	<table border="1"> <thead> <tr> <th>Name</th> <th>Type</th> <th>Use</th> <th>Default</th> <th>Fixed</th> <th>annotation</th> </tr> </thead> <tbody> <tr> <td>cfLangCode</td> <td>xs:string</td> <td>required</td> <td></td> <td></td> <td></td> </tr> <tr> <td>cfTrans</td> <td>cfTrans__Type</td> <td>required</td> <td></td> <td></td> <td></td> </tr> </tbody> </table>	Name	Type	Use	Default	Fixed	annotation	cfLangCode	xs:string	required				cfTrans	cfTrans__Type	required			
Name	Type	Use	Default	Fixed	annotation														
cfLangCode	xs:string	required																	
cfTrans	cfTrans__Type	required																	
<p>source</p>	<p><code><xs:element name="cfTitle" type="cfMLangString__Type"/></code></p>																		

complexType cfResPubl__Type

<p>diagram</p>	
<p>namespace</p>	<p>urn:xmlns.org:eurocris:cerif-1.6-2</p>
<p>children</p>	<p>cfResPublId cfResPublDate cfNum cfVol cfEdition cfSeries cfIssue cfStartPage cfEndPage cfTotalPages cfISBN cfISSN cfURI cfTitle cfAbstr cfKeyw cfBiblNote cfNameAbbrev cfSubtitle cfVersInfo cfResPubl_Event cfOrgUnit_ResPubl cfPers_ResPubl cfProj_ResPubl cfResPubl_ResPubl cfResPubl_Class cfResPubl_Fund cfResPubl_DC cfResPubl_Cite cfResPubl_Metrics cfResPubl_Meas cfResPubl_Indic cfFedId</p>
<p>used by</p>	<p>element CERIF/cfResPubl</p>

source	<pre> <xs:complexType name="cfResPubl__Type"> <xs:sequence> <xs:element name="cfResPublId" type="cfId__Type"/> <xs:element name="cfResPublDate" type="xs:date" minOccurs="0"/> <xs:element name="cfNum" type="xs:string" minOccurs="0"/> <xs:element name="cfVol" type="xs:string" minOccurs="0"/> <xs:element name="cfEdition" type="xs:string" minOccurs="0"/> <xs:element name="cfSeries" type="xs:string" minOccurs="0"/> <xs:element name="cfIssue" type="xs:string" minOccurs="0"/> <xs:element name="cfStartPage" type="xs:string" minOccurs="0"/> <xs:element name="cfEndPage" type="xs:string" minOccurs="0"/> <xs:element name="cfTotalPages" type="xs:string" minOccurs="0"/> <xs:element name="cfISBN" type="xs:string" minOccurs="0"/> <xs:element name="cfISSN" type="xs:string" minOccurs="0"/> <xs:element name="cfURI" type="xs:string" minOccurs="0"/> <xs:choice minOccurs="0" maxOccurs="unbounded"> <!-- embedded multiple-language attributes --> <xs:element name="cfTitle" type="cfMLangString__Type"/> <xs:element name="cfAbstr" type="cfMLangString__Type"/> <xs:element name="cfKeyw" type="cfMLangString__Type"/> <xs:element name="cfBiblNote" type="cfMLangString__Type"/> <xs:element name="cfNameAbbrev" type="cfMLangString__Type"/> <xs:element name="cfSubtitle" type="cfMLangString__Type"/> <xs:element name="cfVersInfo" type="cfMLangString__Type"/> <!-- embedded linking entities --> <xs:element name="cfResPubl_Event"> <xs:complexType> <xs:sequence> <xs:element name="cfEventId" type="cfId__Type"/> <xs:group ref="cfCoreClassWithFraction__Group"/> </xs:sequence> </xs:complexType> </xs:element> <xs:element name="cfOrgUnit_ResPubl"> <xs:complexType> <xs:sequence> <xs:element name="cfOrgUnitId" type="cfId__Type"/> <xs:group ref="cfCoreClassWithFraction__Group"/> <xs:element name="cfCopyright" type="xs:string" minOccurs="0"/> <xs:element name="cfOrder" type="xs:int" minOccurs="0"/> </xs:sequence> </xs:complexType> </xs:element> <xs:element name="cfPers_ResPubl"> <xs:complexType> <xs:sequence> <xs:element name="cfPersId" type="cfId__Type"/> <xs:group ref="cfCoreClassWithFraction__Group"/> <xs:element name="cfCopyright" type="xs:string" minOccurs="0"/> <xs:element name="cfOrder" type="xs:int" minOccurs="0"/> </xs:sequence> </xs:complexType> </xs:element> <xs:element name="cfProj_ResPubl"> <xs:complexType> <xs:sequence> <xs:element name="cfProjId" type="cfId__Type"/> <xs:group ref="cfCoreClassWithFraction__Group"/> <xs:element name="cfCopyright" type="xs:string" minOccurs="0"/> </xs:sequence> </xs:complexType> </xs:element> </xs:choice> </xs:sequence> </xs:complexType> </pre>
--------	--

```

<xs:element name="cfResPubl_ResPubl">
  <xs:complexType>
    <xs:sequence>
      <xs:choice>
        <xs:element name="cfResPublId2" type="cfId__Type"/>
        <xs:element name="cfResPublId1" type="cfId__Type"/>
      </xs:choice>
      <xs:group ref="cfCoreClassWithFraction__Group"/>
    </xs:sequence>
  </xs:complexType>
</xs:element>
<xs:element name="cfResPubl_Class" type="cfCoreClassWithFraction__Type"/>
<xs:element name="cfResPubl_Fund">
  <xs:complexType>
    <xs:sequence>
      <xs:element name="cfFundId" type="cfId__Type"/>
      <xs:group ref="cfCoreClassWithFraction__Group"/>
      <xs:element name="cfAmount" type="cfAmount__Type" minOccurs="0"/>
    </xs:sequence>
  </xs:complexType>
</xs:element>
<xs:element name="cfResPubl_DC">
  <xs:complexType>
    <xs:sequence>
      <xs:sequence>
        <xs:element name="cfDCId" type="xs:string"/>
        <xs:element name="cfDCScheme" type="xs:string"/>
      </xs:sequence>
      <xs:group ref="cfCoreClassWithFraction__Group"/>
    </xs:sequence>
  </xs:complexType>
</xs:element>
<xs:element name="cfResPubl_Cite">
  <xs:complexType>
    <xs:sequence>
      <xs:element name="cfCiteId" type="cfId__Type"/>
      <xs:group ref="cfCoreClassWithFraction__Group"/>
      <xs:element name="cfYear" type="xs:int" minOccurs="0"/>
      <xs:element name="cfCount" type="xs:float" minOccurs="0"/>
    </xs:sequence>
  </xs:complexType>
</xs:element>
<xs:element name="cfResPubl_Metrics">
  <xs:complexType>
    <xs:sequence>
      <xs:element name="cfMetricsId" type="cfId__Type"/>
      <xs:group ref="cfCoreClassWithFraction__Group"/>
      <xs:element name="cfYear" type="xs:int" minOccurs="0"/>
      <xs:element name="cfCount" type="xs:float" minOccurs="0"/>
    </xs:sequence>
  </xs:complexType>
</xs:element>
<xs:element name="cfResPubl_Meas">
  <xs:complexType>
    <xs:sequence>
      <xs:element name="cfMeasId" type="cfId__Type"/>
      <xs:group ref="cfCoreClassWithFraction__Group"/>
    </xs:sequence>
  </xs:complexType>
</xs:element>
<xs:element name="cfResPubl_Indic">
  <xs:complexType>

```

	<pre> <xs:sequence> <xs:element name="cfIndicld" type="cfld__Type"/> <xs:group ref="cfCoreClassWithFraction__Group"/> </xs:sequence> </xs:complexType> </xs:element> <!-- embedded federated identifiers --> <xs:element name="cfFedld" type="cfFedld__EmbType"/> </xs:choice> </xs:sequence> </xs:complexType> </pre>
--	--

element cfResPubl__Type/cfResPubld

diagram	
namespace	urn:xmlns:org:eurocris:cerif-1.6-2
type	cfld__Type
properties	isRef 0 content simple
facets	Kind Value annotation maxLength 128
source	<pre><xs:element name="cfResPubld" type="cfld__Type"/></pre>

element cfResPubl__Type/cfResPublDate

diagram	
namespace	urn:xmlns:org:eurocris:cerif-1.6-2
type	xs:date
properties	isRef 0 minOcc 0 maxOcc 1 content simple
source	<pre><xs:element name="cfResPublDate" type="xs:date" minOccurs="0"/></pre>

element cfResPubl__Type/cfNum

diagram	
namespace	urn:xmlns:org:eurocris:cerif-1.6-2
type	xs:string
properties	isRef 0 minOcc 0 maxOcc 1 content simple
source	<pre><xs:element name="cfNum" type="xs:string" minOccurs="0"/></pre>

element cfResPubl__Type/cfVol

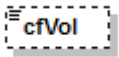
diagram	
namespace	urn:xmlns:org:eurocris:cerif-1.6-2
type	xs:string
properties	isRef 0 minOcc 0 maxOcc 1

	content simple
source	<code><xs:element name="cfVol" type="xs:string" minOccurs="0"/></code>

element **cfResPubl__Type/cfEdition**

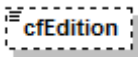
diagram	
namespace	urn:xmlns:org:eurocris:cerif-1.6-2
type	xs:string
properties	isRef 0 minOcc 0 maxOcc 1 content simple
source	<code><xs:element name="cfEdition" type="xs:string" minOccurs="0"/></code>

element **cfResPubl__Type/cfSeries**

diagram	
namespace	urn:xmlns:org:eurocris:cerif-1.6-2
type	xs:string
properties	isRef 0 minOcc 0 maxOcc 1 content simple
source	<code><xs:element name="cfSeries" type="xs:string" minOccurs="0"/></code>

element **cfResPubl__Type/cfIssue**

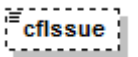
diagram	
namespace	urn:xmlns:org:eurocris:cerif-1.6-2
type	xs:string
properties	isRef 0 minOcc 0 maxOcc 1 content simple
source	<code><xs:element name="cfIssue" type="xs:string" minOccurs="0"/></code>

element **cfResPubl__Type/cfStartPage**

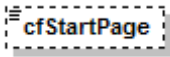
diagram	
namespace	urn:xmlns:org:eurocris:cerif-1.6-2
type	xs:string
properties	isRef 0 minOcc 0 maxOcc 1 content simple
source	<code><xs:element name="cfStartPage" type="xs:string" minOccurs="0"/></code>

element **cfResPubl__Type/cfEndPage**

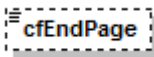
diagram	
namespace	urn:xmlns:org:eurocris:cerif-1.6-2

type	xs:string
properties	isRef 0 minOcc 0 maxOcc 1 content simple
source	<code><xs:element name="cfEndPage" type="xs:string" minOccurs="0"/></code>

element cfResPubl__Type/cfTotalPages

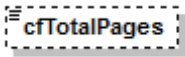
diagram	
namespace	urn:xmlns:org:eurocris:cerif-1.6-2
type	xs:string
properties	isRef 0 minOcc 0 maxOcc 1 content simple
source	<code><xs:element name="cfTotalPages" type="xs:string" minOccurs="0"/></code>

element cfResPubl__Type/cfISBN

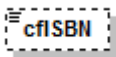
diagram	
namespace	urn:xmlns:org:eurocris:cerif-1.6-2
type	xs:string
properties	isRef 0 minOcc 0 maxOcc 1 content simple
source	<code><xs:element name="cfISBN" type="xs:string" minOccurs="0"/></code>

element cfResPubl__Type/cfISSN

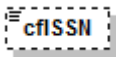
diagram	
namespace	urn:xmlns:org:eurocris:cerif-1.6-2
type	xs:string
properties	isRef 0 minOcc 0 maxOcc 1 content simple
source	<code><xs:element name="cfISSN" type="xs:string" minOccurs="0"/></code>

element cfResPubl__Type/cfURI

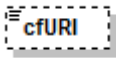
diagram	
namespace	urn:xmlns:org:eurocris:cerif-1.6-2
type	xs:string
properties	isRef 0 minOcc 0 maxOcc 1 content simple
source	<code><xs:element name="cfURI" type="xs:string" minOccurs="0"/></code>

element cfResPubl__Type/cfTitle

diagram						
namespace	urn:xmlns:org:eurocris:cerif-1.6-2					
type	cfMLangString__Type					
properties	isRef	0	content	complex		
attributes	Name	Type	Use	Default	Fixed	annotation
	cfLangCode	xs:string	required			
	cfTrans	cfTrans__Type	required			
source	<xs:element name="cfTitle" type="cfMLangString__Type"/>					

element cfResPubl__Type/cfAbstr

diagram						
namespace	urn:xmlns:org:eurocris:cerif-1.6-2					
type	cfMLangString__Type					
properties	isRef	0	content	complex		
attributes	Name	Type	Use	Default	Fixed	annotation
	cfLangCode	xs:string	required			
	cfTrans	cfTrans__Type	required			
source	<xs:element name="cfAbstr" type="cfMLangString__Type"/>					

element cfResPubl__Type/cfKeyw

diagram						
namespace	urn:xmlns:org:eurocris:cerif-1.6-2					
type	cfMLangString__Type					
properties	isRef	0	content	complex		

attributes	Name	Type	Use	Default	Fixed	annotation
	cfLangCode	xs:string	required			
	cfTrans	cfTrans_Type	required			
source	<code><xs:element name="cfKeyw" type="cfMLangString__Type"/></code>					

element **cfResPubl__Type/cfBiblNote**

diagram						
namespace	urn.xmlns:org:eurocris:cerif-1.6-2					
type	cfMLangString_Type					
properties	isRef	0				
	content	complex				
attributes	Name	Type	Use	Default	Fixed	annotation
	cfLangCode	xs:string	required			
	cfTrans	cfTrans_Type	required			
source	<code><xs:element name="cfBiblNote" type="cfMLangString__Type"/></code>					

element **cfResPubl__Type/cfNameAbbrev**

diagram						
namespace	urn.xmlns:org:eurocris:cerif-1.6-2					
type	cfMLangString_Type					
properties	isRef	0				
	content	complex				
attributes	Name	Type	Use	Default	Fixed	annotation
	cfLangCode	xs:string	required			
	cfTrans	cfTrans_Type	required			
source	<code><xs:element name="cfNameAbbrev" type="cfMLangString__Type"/></code>					

element cfResPubl__Type/cfSubtitle

diagram																			
namespace	urn:xmlns:org:eurocris:cerif-1.6-2																		
type	cfMLangString__Type																		
properties	isRef 0 content complex																		
attributes	<table border="1"> <thead> <tr> <th>Name</th> <th>Type</th> <th>Use</th> <th>Default</th> <th>Fixed</th> <th>annotation</th> </tr> </thead> <tbody> <tr> <td>cfLangCode</td> <td>xs:string</td> <td>required</td> <td></td> <td></td> <td></td> </tr> <tr> <td>cfTrans</td> <td>cfTrans__Type</td> <td>required</td> <td></td> <td></td> <td></td> </tr> </tbody> </table>	Name	Type	Use	Default	Fixed	annotation	cfLangCode	xs:string	required				cfTrans	cfTrans__Type	required			
Name	Type	Use	Default	Fixed	annotation														
cfLangCode	xs:string	required																	
cfTrans	cfTrans__Type	required																	
source	<xs:element name="cfSubtitle" type="cfMLangString__Type"/>																		

element cfResPubl__Type/cfVersInfo

diagram																			
namespace	urn:xmlns:org:eurocris:cerif-1.6-2																		
type	cfMLangString__Type																		
properties	isRef 0 content complex																		
attributes	<table border="1"> <thead> <tr> <th>Name</th> <th>Type</th> <th>Use</th> <th>Default</th> <th>Fixed</th> <th>annotation</th> </tr> </thead> <tbody> <tr> <td>cfLangCode</td> <td>xs:string</td> <td>required</td> <td></td> <td></td> <td></td> </tr> <tr> <td>cfTrans</td> <td>cfTrans__Type</td> <td>required</td> <td></td> <td></td> <td></td> </tr> </tbody> </table>	Name	Type	Use	Default	Fixed	annotation	cfLangCode	xs:string	required				cfTrans	cfTrans__Type	required			
Name	Type	Use	Default	Fixed	annotation														
cfLangCode	xs:string	required																	
cfTrans	cfTrans__Type	required																	
source	<xs:element name="cfVersInfo" type="cfMLangString__Type"/>																		

element cfResPubl__Type/cfResPubl_Event

diagram	
namespace	urn:xmlns:org:eurocris:cerif-1.6-2
properties	isRef 0 content complex
children	cfEventId cfClassId cfClassSchemeld cfStartDate cfEndDate cfFraction
source	<xs:element name="cfResPubl_Event">

	<pre> <xs:complexType> <xs:sequence> <xs:element name="cfEventId" type="cfd__Type"/> <xs:group ref="cfCoreClassWithFraction__Group"/> </xs:sequence> </xs:complexType> </xs:element> </pre>
--	---

element cfResPubl__Type/cfResPubl_Event/cfEventId

diagram							
namespace	urn:xmlns:org:eurocris:cerif-1.6-2						
type	cfd__Type						
properties	isRef 0 content simple						
facets	<table border="1"> <thead> <tr> <th>Kind</th> <th>Value</th> <th>annotation</th> </tr> </thead> <tbody> <tr> <td>maxLength</td> <td>128</td> <td></td> </tr> </tbody> </table>	Kind	Value	annotation	maxLength	128	
Kind	Value	annotation					
maxLength	128						
source	<code><xs:element name="cfEventId" type="cfd__Type"/></code>						

element cfResPubl__Type/cfOrgUnit_ResPubl

diagram	
namespace	urn:xmlns:org:eurocris:cerif-1.6-2
properties	isRef 0 content complex
children	cfOrgUnitId cfClassId cfClassSchemeld cfStartDate cfEndDate cfFraction cfCopyright cfOrder
source	<pre> <xs:element name="cfOrgUnit_ResPubl"> <xs:complexType> <xs:sequence> <xs:element name="cfOrgUnitId" type="cfd__Type"/> <xs:group ref="cfCoreClassWithFraction__Group"/> <xs:element name="cfCopyright" type="xs:string" minOccurs="0"/> <xs:element name="cfOrder" type="xs:int" minOccurs="0"/> </xs:sequence> </xs:complexType> </xs:element> </pre>

element cfResPubl__Type/cfOrgUnit_ResPubl/cfOrgUnitId

diagram	
namespace	urn:xmlns:org:eurocris:cerif-1.6-2
type	cfd__Type
properties	isRef 0 content simple

facets	Kind maxLength	Value 128	annotation
source	<code><xs:element name="cfOrgUnitId" type="cfId__Type"/></code>		

element cfResPubl__Type/cfOrgUnit_ResPubl/cfCopyright

diagram	
namespace	urn:xmlns:org:eurocris:cerif-1.6-2
type	xs:string
properties	isRef 0 minOcc 0 maxOcc 1 content simple
source	<code><xs:element name="cfCopyright" type="xs:string" minOccurs="0"/></code>

element cfResPubl__Type/cfOrgUnit_ResPubl/cfOrder

diagram	
namespace	urn:xmlns:org:eurocris:cerif-1.6-2
type	xs:int
properties	isRef 0 minOcc 0 maxOcc 1 content simple
source	<code><xs:element name="cfOrder" type="xs:int" minOccurs="0"/></code>

element cfResPubl__Type/cfPers_ResPubl

diagram	
namespace	urn:xmlns:org:eurocris:cerif-1.6-2
properties	isRef 0 content complex
children	cfPersId cfClassId cfClassSchemeld cfStartDate cfEndDate cfFraction cfCopyright cfOrder
source	<code><xs:element name="cfPers_ResPubl"> <xs:complexType> <xs:sequence> <xs:element name="cfPersId" type="cfId__Type"/> <xs:group ref="cfCoreClassWithFraction__Group"/> <xs:element name="cfCopyright" type="xs:string" minOccurs="0"/> <xs:element name="cfOrder" type="xs:int" minOccurs="0"/> </xs:sequence> </xs:complexType> </xs:element></code>

element **cfResPubl_Type/cfPers_ResPubl/cfPersId**

diagram	
namespace	urn:xmlns:org:eurocris:cerif-1.6-2
type	cfd__Type
properties	isRef 0 content simple
facets	Kind Value annotation maxLength 128
source	<code><xs:element name="cfPersId" type="cfd__Type"/></code>

element **cfResPubl_Type/cfPers_ResPubl/cfCopyright**

diagram	
namespace	urn:xmlns:org:eurocris:cerif-1.6-2
type	xs:string
properties	isRef 0 minOcc 0 maxOcc 1 content simple
source	<code><xs:element name="cfCopyright" type="xs:string" minOccurs="0"/></code>

element **cfResPubl_Type/cfPers_ResPubl/cfOrder**

diagram	
namespace	urn:xmlns:org:eurocris:cerif-1.6-2
type	xs:int
properties	isRef 0 minOcc 0 maxOcc 1 content simple
source	<code><xs:element name="cfOrder" type="xs:int" minOccurs="0"/></code>

element **cfResPubl_Type/cfProj_ResPubl**

diagram	
namespace	urn:xmlns:org:eurocris:cerif-1.6-2
properties	isRef 0 content complex
children	cfProjId cfClassId cfClassSchemeld cfStartDate cfEndDate cfFraction cfCopyright
source	<code><xs:element name="cfProj_ResPubl"> <xs:complexType> <xs:sequence></code>

	<pre> <xs:element name="cfProjld" type="cfld__Type"/> <xs:group ref="cfCoreClassWithFraction__Group"/> <xs:element name="cfCopyright" type="xs:string" minOccurs="0"/> </xs:sequence> </xs:complexType> </xs:element> </pre>
--	--

element cfResPubl__Type/cfProj_ResPubl/cfProjld

diagram	
namespace	urn:xmlns:org:eurocris:cerif-1.6-2
type	cfld__Type
properties	isRef 0 content simple
facets	Kind Value annotation maxLength 128
source	<pre><xs:element name="cfProjld" type="cfld__Type"/></pre>

element cfResPubl__Type/cfProj_ResPubl/cfCopyright

diagram	
namespace	urn:xmlns:org:eurocris:cerif-1.6-2
type	xs:string
properties	isRef 0 minOcc 0 maxOcc 1 content simple
source	<pre><xs:element name="cfCopyright" type="xs:string" minOccurs="0"/></pre>

element cfResPubl__Type/cfResPubl_ResPubl

diagram	
namespace	urn:xmlns:org:eurocris:cerif-1.6-2
properties	isRef 0 content complex
children	cfResPubld2 cfResPubld1 cfClassId cfClassSchemeld cfStartDate cfEndDate cfFraction
source	<pre> <xs:element name="cfResPubl_ResPubl"> <xs:complexType> <xs:sequence> <xs:choice> <xs:element name="cfResPubld2" type="cfld__Type"/> <xs:element name="cfResPubld1" type="cfld__Type"/> </xs:choice> <xs:group ref="cfCoreClassWithFraction__Group"/> </xs:sequence> </xs:complexType> </pre>

	<code></xs:element></code>
--	----------------------------------

element cfResPubl__Type/cfResPubl_ResPubl/cfResPublId2

diagram	
namespace	urn:xmlns:org:eurocris:cerif-1.6-2
type	cfd_Type
properties	isRef 0 content simple
facets	Kind Value annotation maxLength 128
source	<code><xs:element name="cfResPublId2" type="cfd__Type"/></code>

element cfResPubl__Type/cfResPubl_ResPubl/cfResPublId1

diagram	
namespace	urn:xmlns:org:eurocris:cerif-1.6-2
type	cfd_Type
properties	isRef 0 content simple
facets	Kind Value annotation maxLength 128
source	<code><xs:element name="cfResPublId1" type="cfd__Type"/></code>

element cfResPubl__Type/cfResPubl_Class

diagram	
namespace	urn:xmlns:org:eurocris:cerif-1.6-2
type	cfCoreClassWithFraction_Type
properties	isRef 0 content complex
children	cfClassId cfClassSchemeld cfStartDate cfEndDate cfFraction
source	<code><xs:element name="cfResPubl_Class" type="cfCoreClassWithFraction__Type"/></code>

element **cfResPubl__Type/cfResPubl_Fund**

diagram	
namespace	urn.xmlns:org:eurocris:cerif-1.6-2
properties	isRef 0 content complex
children	cfFundId cfClassId cfClassSchemeld cfStartDate cfEndDate cfFraction cfAmount
source	<pre><xs:element name="cfResPubl_Fund"> <xs:complexType> <xs:sequence> <xs:element name="cfFundId" type="cfId__Type"/> <xs:group ref="cfCoreClassWithFraction_Group"/> <xs:element name="cfAmount" type="cfAmount__Type" minOccurs="0"/> </xs:sequence> </xs:complexType> </xs:element></pre>

element **cfResPubl__Type/cfResPubl_Fund/cfFundId**

diagram	
namespace	urn.xmlns:org:eurocris:cerif-1.6-2
type	cfId__Type
properties	isRef 0 content simple
facets	Kind Value annotation maxLength 128
source	<pre><xs:element name="cfFundId" type="cfId__Type"/></pre>

element **cfResPubl__Type/cfResPubl_Fund/cfAmount**

diagram													
namespace	urn.xmlns:org:eurocris:cerif-1.6-2												
type	cfAmount__Type												
properties	isRef 0 minOcc 0 maxOcc 1 content complex												
attributes	<table border="1"> <thead> <tr> <th>Name</th> <th>Type</th> <th>Use</th> <th>Default</th> <th>Fixed</th> <th>annotation</th> </tr> </thead> <tbody> <tr> <td>cfCurrCode</td> <td>xs:string</td> <td>required</td> <td></td> <td></td> <td></td> </tr> </tbody> </table>	Name	Type	Use	Default	Fixed	annotation	cfCurrCode	xs:string	required			
Name	Type	Use	Default	Fixed	annotation								
cfCurrCode	xs:string	required											
source	<pre><xs:element name="cfAmount" type="cfAmount__Type" minOccurs="0"/></pre>												

element cfResPubl__Type/cfResPubl_DC

diagram	
namespace	urn:xmlns:org:eurocris:cerif-1.6-2
properties	isRef 0 content complex
children	cfDCId cfDCScheme cfClassId cfClassSchemeld cfStartDate cfEndDate cfFraction
source	<pre> <xs:element name="cfResPubl_DC"> <xs:complexType> <xs:sequence> <xs:sequence> <xs:element name="cfDCId" type="xs:string"/> <xs:element name="cfDCScheme" type="xs:string"/> </xs:sequence> <xs:group ref="cfCoreClassWithFraction__Group"/> </xs:sequence> </xs:complexType> </xs:element> </pre>

element cfResPubl__Type/cfResPubl_DC/cfDCId

diagram	
namespace	urn:xmlns:org:eurocris:cerif-1.6-2
type	xs:string
properties	isRef 0 content simple
source	<pre> <xs:element name="cfDCId" type="xs:string"/> </pre>

element cfResPubl__Type/cfResPubl_DC/cfDCScheme

diagram	
namespace	urn:xmlns:org:eurocris:cerif-1.6-2
type	xs:string
properties	isRef 0 content simple
source	<pre> <xs:element name="cfDCScheme" type="xs:string"/> </pre>

element cfResPubl__Type/cfResPubl__Cite

diagram	
namespace	urn:xmlns:org:eurocris:cerif-1.6-2
properties	isRef 0 content complex
children	cfCiteId cfClassId cfClassSchemeld cfStartDate cfEndDate cfFraction cfYear cfCount
source	<pre> <xs:element name="cfResPubl__Cite"> <xs:complexType> <xs:sequence> <xs:element name="cfCiteId" type="cfId__Type"/> <xs:group ref="cfCoreClassWithFraction__Group"/> <xs:element name="cfYear" type="xs:int" minOccurs="0"/> <xs:element name="cfCount" type="xs:float" minOccurs="0"/> </xs:sequence> </xs:complexType> </xs:element> </pre>

element cfResPubl__Type/cfResPubl__Cite/cfCiteId

diagram	
namespace	urn:xmlns:org:eurocris:cerif-1.6-2
type	cfId__Type
properties	isRef 0 content simple
facets	Kind Value annotation maxLength 128
source	<pre> <xs:element name="cfCiteId" type="cfId__Type"/> </pre>

element cfResPubl__Type/cfResPubl__Cite/cfYear

diagram	
namespace	urn:xmlns:org:eurocris:cerif-1.6-2
type	xs:int
properties	isRef 0 minOcc 0 maxOcc 1 content simple
source	<pre> <xs:element name="cfYear" type="xs:int" minOccurs="0"/> </pre>

element **cfResPubl__Type/cfResPubl_Cite/cfCount**

diagram	
namespace	urn:xmlns:org:eurocris:cerif-1.6-2
type	xs:float
properties	isRef 0 minOcc 0 maxOcc 1 content simple
source	<code><xs:element name="cfCount" type="xs:float" minOccurs="0"/></code>

element **cfResPubl__Type/cfResPubl_Metrics**

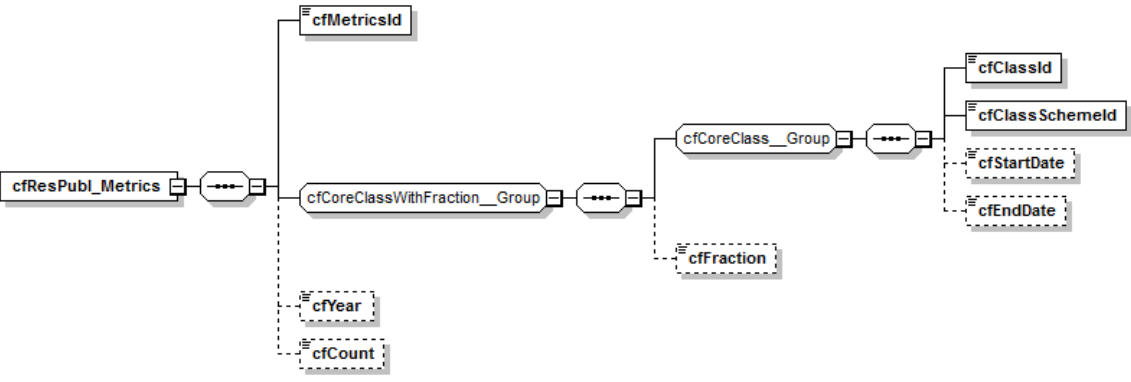
diagram	
namespace	urn:xmlns:org:eurocris:cerif-1.6-2
properties	isRef 0 content complex
children	cfMetricsId cfClassId cfClassSchemeId cfStartDate cfEndDate cfFraction cfYear cfCount
source	<pre><xs:element name="cfResPubl_Metrics"> <xs:complexType> <xs:sequence> <xs:element name="cfMetricsId" type="cFld__Type"/> <xs:group ref="cfCoreClassWithFraction__Group"/> <xs:element name="cfYear" type="xs:int" minOccurs="0"/> <xs:element name="cfCount" type="xs:float" minOccurs="0"/> </xs:sequence> </xs:complexType> </xs:element></pre>

element **cfResPubl__Type/cfResPubl_Metrics/cfMetricsId**

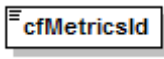
diagram	
namespace	urn:xmlns:org:eurocris:cerif-1.6-2
type	cFld__Type
properties	isRef 0 content simple
facets	Kind Value annotation maxLength 128
source	<code><xs:element name="cfMetricsId" type="cFld__Type"/></code>

element **cfResPubl__Type/cfResPubl_Metrics/cfYear**

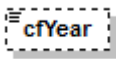
diagram	
---------	---

namespace	urn:xmlns:org:eurocris:cerif-1.6-2
type	xs:int
properties	isRef 0 minOcc 0 maxOcc 1 content simple
source	<code><xs:element name="cfYear" type="xs:int" minOccurs="0"/></code>

element cfResPubl__Type/cfResPubl_Metrics/cfCount

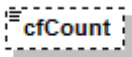
diagram	
namespace	urn:xmlns:org:eurocris:cerif-1.6-2
type	xs:float
properties	isRef 0 minOcc 0 maxOcc 1 content simple
source	<code><xs:element name="cfCount" type="xs:float" minOccurs="0"/></code>

element cfResPubl__Type/cfResPubl_Meas

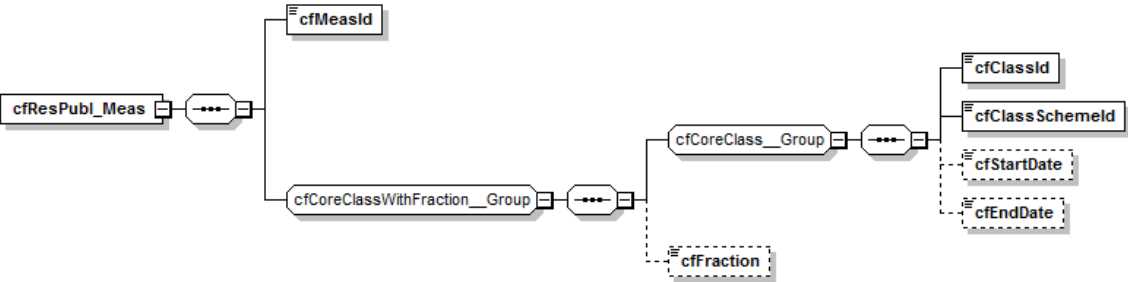
diagram	
namespace	urn:xmlns:org:eurocris:cerif-1.6-2
properties	isRef 0 content complex
children	cfMeasId cfClassid cfClassSchemeld cfStartDate cfEndDate cfFraction
source	<pre><xs:element name="cfResPubl_Meas"> <xs:complexType> <xs:sequence> <xs:element name="cfMeasId" type="cflD__Type"/> <xs:group ref="cfCoreClassWithFraction__Group"/> </xs:sequence> </xs:complexType> </xs:element></pre>

element cfResPubl__Type/cfResPubl_Meas/cfMeasId

diagram	
namespace	urn:xmlns:org:eurocris:cerif-1.6-2
type	cflD__Type
properties	isRef 0 content simple
facets	Kind Value annotation maxLength 128
source	<code><xs:element name="cfMeasId" type="cflD__Type"/></code>

element **cfResPubl_Type/cfResPubl_Indic**

diagram	
namespace	urn:xmlns:org:eurocris:cerif-1.6-2
properties	isRef 0 content complex
children	cfIndicId cfClassId cfClassSchemeld cfStartDate cfEndDate cfFraction
source	<pre><xs:element name="cfResPubl_Indic"> <xs:complexType> <xs:sequence> <xs:element name="cfIndicId" type="cfId__Type"/> <xs:group ref="cfCoreClassWithFraction__Group"/> </xs:sequence> </xs:complexType> </xs:element></pre>

element **cfResPubl_Type/cfResPubl_Indic/cfIndicId**

diagram	
namespace	urn:xmlns:org:eurocris:cerif-1.6-2
type	cfId__Type
properties	isRef 0 content simple
facets	Kind Value annotation maxLength 128
source	<pre><xs:element name="cfIndicId" type="cfId__Type"/></pre>

element **cfResPubl_Type/cfFedId**

diagram	
---------	--

namespace	urn:xmlns:org:eurocris:cerif-1.6-2
type	cfFedld_EmbType
properties	isRef 0 content complex
children	cfFedldld cfFedld cfClassld cfClassSchemeld cfStartDate cfEndDate cfFedld_Class
source	<xs:element name="cfFedld" type="cfFedld__EmbType"/>

complexType [cfResPubl_Cite__Type](#)

diagram	
namespace	urn:xmlns:org:eurocris:cerif-1.6-2
children	cfResPublId cfCiteld cfClassld cfClassSchemeld cfStartDate cfEndDate cfFraction cfYear cfCount
used by	element CERIF/cfResPubl_Cite
source	<pre> <xs:complexType name="cfResPubl_Cite__Type"> <xs:sequence> <xs:element name="cfResPublId" type="cfld__Type"/> <xs:element name="cfCiteld" type="cfld__Type"/> <xs:group ref="cfCoreClassWithFraction__Group"/> <xs:element name="cfYear" type="xs:int" minOccurs="0"/> <xs:element name="cfCount" type="xs:float" minOccurs="0"/> </xs:sequence> </xs:complexType> </pre>

element [cfResPubl_Cite__Type/cfResPublId](#)

diagram	
namespace	urn:xmlns:org:eurocris:cerif-1.6-2
type	cfld__Type
properties	isRef 0 content simple
facets	Kind Value annotation maxLength 128
source	<xs:element name="cfResPublId" type="cfld__Type"/>

element [cfResPubl_Cite__Type/cfCiteld](#)

diagram	
namespace	urn:xmlns:org:eurocris:cerif-1.6-2
type	cfld__Type
properties	isRef 0 content simple

facets	Kind maxLength	Value 128	annotation
source	<code><xs:element name="cfCiteId" type="cfId__Type"/></code>		

element cfResPubl_Cite__Type/cfYear

diagram	
namespace	urn:xmlns:org:eurocris:cerif-1.6-2
type	xs:int
properties	isRef 0 minOcc 0 maxOcc 1 content simple
source	<code><xs:element name="cfYear" type="xs:int" minOccurs="0"/></code>

element cfResPubl_Cite__Type/cfCount

diagram	
namespace	urn:xmlns:org:eurocris:cerif-1.6-2
type	xs:float
properties	isRef 0 minOcc 0 maxOcc 1 content simple
source	<code><xs:element name="cfCount" type="xs:float" minOccurs="0"/></code>

complexType cfResPubl_Class__Type

diagram	
namespace	urn:xmlns:org:eurocris:cerif-1.6-2
children	cfResPublId cfClassId cfClassSchemeld cfStartDate cfEndDate cfFraction
used by	element CERIF/cfResPubl_Class
source	<code><xs:complexType name="cfResPubl_Class__Type"> <xs:sequence> <xs:element name="cfResPublId" type="cfId__Type"/> <xs:group ref="cfCoreClassWithFraction__Group"/> </xs:sequence> </xs:complexType></code>

element cfResPubl_Class__Type/cfResPublId

diagram	
namespace	urn:xmlns:org:eurocris:cerif-1.6-2
type	cfId__Type

properties	isRef 0 content simple
facets	Kind Value annotation maxLength 128
source	<code><xs:element name="cfResPublId" type="cflD__Type"/></code>

complexType cfResPubl_DC__Type

diagram	
namespace	urn:xmlns:org:eurocris:cerif-1.6-2
children	cfResPublId cfDCId cfDCScheme cfClassId cfClassSchemeId cfStartDate cfEndDate cfFraction
used by	element CERIF/cfResPubl_DC
source	<pre> <xs:complexType name="cfResPubl_DC__Type"> <xs:sequence> <xs:element name="cfResPublId" type="cflD__Type"/> <xs:element name="cfDCId" type="xs:string"/> <xs:element name="cfDCScheme" type="xs:string"/> <xs:group ref="cfCoreClassWithFraction__Group"/> </xs:sequence> </xs:complexType> </pre>

element cfResPubl_DC__Type/cfResPublId

diagram	
namespace	urn:xmlns:org:eurocris:cerif-1.6-2
type	cflD__Type
properties	isRef 0 content simple
facets	Kind Value annotation maxLength 128
source	<code><xs:element name="cfResPublId" type="cflD__Type"/></code>

element cfResPubl_DC__Type/cfDCId

diagram	
namespace	urn:xmlns:org:eurocris:cerif-1.6-2
type	xs:string
properties	isRef 0 content simple
source	<code><xs:element name="cfDCId" type="xs:string"/></code>

element **cfResPubl_DC_Type/cfDCScheme**

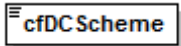
diagram	
namespace	urn:xmlns:org:eurocris:cerif-1.6-2
type	xs:string
properties	isRef 0 content simple
source	<code><xs:element name="cfDCScheme" type="xs:string"/></code>

complexType **cfResPubl_Event_Type**

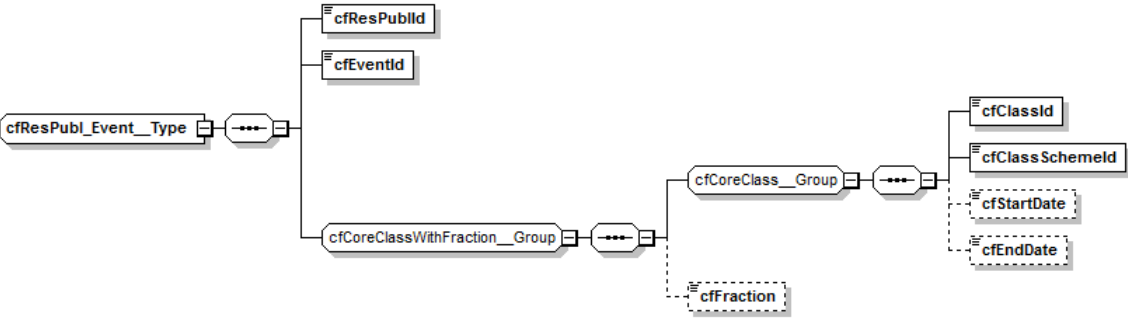
diagram	
namespace	urn:xmlns:org:eurocris:cerif-1.6-2
children	cfResPublId cfEventId cfClassId cfClassSchemeId cfStartDate cfEndDate cfFraction
used by	element CERIF/cfResPubl_Event
source	<pre><xs:complexType name="cfResPubl_Event_Type"> <xs:sequence> <xs:element name="cfResPublId" type="cfId_Type"/> <xs:element name="cfEventId" type="cfId_Type"/> <xs:group ref="cfCoreClassWithFraction_Group"/> </xs:sequence> </xs:complexType></pre>

element **cfResPubl_Event_Type/cfResPublId**

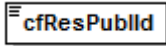
diagram	
namespace	urn:xmlns:org:eurocris:cerif-1.6-2
type	cfId_Type
properties	isRef 0 content simple
facets	Kind Value annotation maxLength 128
source	<code><xs:element name="cfResPublId" type="cfId_Type"/></code>

element **cfResPubl_Event_Type/cfEventId**

diagram	
namespace	urn:xmlns:org:eurocris:cerif-1.6-2
type	cfId_Type
properties	isRef 0 content simple
facets	Kind Value annotation maxLength 128

source	<xs:element name="cfEventId" type="cfId__Type"/>
--------	--

complexType cfResPubl_Fund_Type

diagram	
namespace	urn:xmlns:org:eurocris:cerif-1.6-2
children	cfResPublId cfFundId cfClassId cfClassSchemeld cfStartDate cfEndDate cfFraction cfAmount
used by	element CERIF/cfResPubl_Fund
source	<pre><xs:complexType name="cfResPubl_Fund__Type"> <xs:sequence> <xs:element name="cfResPublId" type="cfId__Type"/> <xs:element name="cfFundId" type="cfId__Type"/> <xs:group ref="cfCoreClassWithFraction__Group"/> <xs:element name="cfAmount" type="cfAmount__Type" minOccurs="0"/> </xs:sequence> </xs:complexType></pre>

element cfResPubl_Fund_Type/cfResPublId

diagram	
namespace	urn:xmlns:org:eurocris:cerif-1.6-2
type	cfId__Type
properties	isRef 0 content simple
facets	Kind Value annotation maxLength 128
source	<xs:element name="cfResPublId" type="cfId__Type"/>

element cfResPubl_Fund_Type/cfFundId

diagram	
namespace	urn:xmlns:org:eurocris:cerif-1.6-2
type	cfId__Type
properties	isRef 0 content simple
facets	Kind Value annotation maxLength 128
source	<xs:element name="cfFundId" type="cfId__Type"/>

element **cfResPubl_Fund_Type/cfAmount**

diagram						
namespace	urn:xmlns:org:eurocris:cerif-1.6-2					
type	cfAmount_Type					
properties	isRef	0	minOcc	0	maxOcc	1
	content	complex				
attributes	Name	Type	Use	Default	Fixed	annotation
	cfCurrCode	xs:string	required			
source	<pre><xs:element name="cfAmount" type="cfAmount_Type" minOccurs="0"/></pre>					

complexType **cfResPubl_Indic_Type**

diagram						
namespace	urn:xmlns:org:eurocris:cerif-1.6-2					
children	cfResPublId cfIndicId cfClassId cfClassSchemeId cfStartDate cfEndDate cfFraction					
used by	element	CERIF/cfResPubl_Indic				
source	<pre><xs:complexType name="cfResPubl_Indic_Type"> <xs:sequence> <xs:element name="cfResPublId" type="cFld_Type"/> <xs:element name="cfIndicId" type="cFld_Type"/> <xs:group ref="cfCoreClassWithFraction_Group"/> </xs:sequence> </xs:complexType></pre>					

element **cfResPubl_Indic_Type/cfResPublId**

diagram						
namespace	urn:xmlns:org:eurocris:cerif-1.6-2					
type	cFld_Type					
properties	isRef	0	content	simple		
facets	Kind	Value	annotation			
	maxLength	128				
source	<pre><xs:element name="cfResPublId" type="cFld_Type"/></pre>					

element **cfResPubl_Indic_Type/cfIndicId**

diagram	
namespace	urn:xmlns:org:eurocris:cerif-1.6-2
type	cfd_Type
properties	isRef 0 content simple
facets	Kind Value annotation maxLength 128
source	<code><xs:element name="cfIndicId" type="cfd_Type"/></code>

complexType **cfResPubl_Meas_Type**

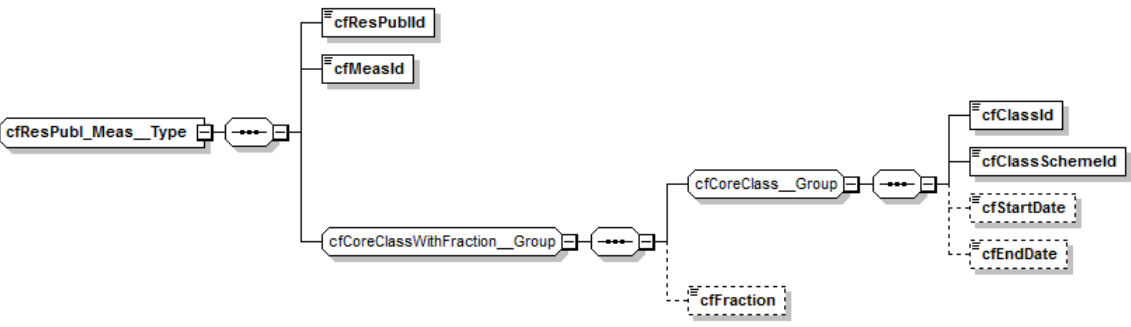
diagram	
namespace	urn:xmlns:org:eurocris:cerif-1.6-2
children	cfResPublId cfMeasId cfClassId cfClassSchemeld cfStartDate cfEndDate cfFraction
used by	element CERIF/cfResPubl_Meas
source	<pre><xs:complexType name="cfResPubl_Meas_Type"> <xs:sequence> <xs:element name="cfResPublId" type="cfd_Type"/> <xs:element name="cfMeasId" type="cfd_Type"/> <xs:group ref="cfCoreClassWithFraction_Group"/> </xs:sequence> </xs:complexType></pre>

element **cfResPubl_Meas_Type/cfResPublId**

diagram	
namespace	urn:xmlns:org:eurocris:cerif-1.6-2
type	cfd_Type
properties	isRef 0 content simple
facets	Kind Value annotation maxLength 128
source	<code><xs:element name="cfResPublId" type="cfd_Type"/></code>

element **cfResPubl_Meas_Type/cfMeasId**

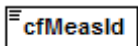
diagram	
namespace	urn:xmlns:org:eurocris:cerif-1.6-2
type	cfd_Type
properties	isRef 0 content simple

facets	Kind maxLength	Value 128	annotation
source	<code><xs:element name="cfMeasId" type="cfld__Type"/></code>		

complexType **cfResPubl_Metrics__Type**

diagram	
namespace	urn:xmlns:org:eurocris:cerif-1.6-2
children	cfResPublId cfMetricsId cfClassId cfClassSchemeld cfStartDate cfEndDate cfFraction cfYear cfCount
used by	element CERIF/cfResPubl_Metrics
source	<pre> <xs:complexType name="cfResPubl_Metrics__Type"> <xs:sequence> <xs:element name="cfResPublId" type="cfld__Type"/> <xs:element name="cfMetricsId" type="cfld__Type"/> <xs:group ref="cfCoreClassWithFraction__Group"/> <xs:element name="cfYear" type="xs:int" minOccurs="0"/> <xs:element name="cfCount" type="xs:float" minOccurs="0"/> </xs:sequence> </xs:complexType> </pre>

element **cfResPubl_Metrics__Type/cfResPublId**

diagram			
namespace	urn:xmlns:org:eurocris:cerif-1.6-2		
type	cfld__Type		
properties	isRef 0 content simple		
facets	Kind maxLength	Value 128	annotation
source	<code><xs:element name="cfResPublId" type="cfld__Type"/></code>		

element **cfResPubl_Metrics__Type/cfMetricsId**

diagram			
namespace	urn:xmlns:org:eurocris:cerif-1.6-2		
type	cfld__Type		
properties	isRef 0 content simple		
facets	Kind maxLength	Value 128	annotation
source	<code><xs:element name="cfMetricsId" type="cfld__Type"/></code>		

element **cfResPubl_Metrics_Type/cfYear**

diagram	
namespace	urn:xmlns:org:eurocris:cerif-1.6-2
type	xs:int
properties	isRef 0 minOcc 0 maxOcc 1 content simple
source	<code><xs:element name="cfYear" type="xs:int" minOccurs="0"/></code>

element **cfResPubl_Metrics_Type/cfCount**

diagram	
namespace	urn:xmlns:org:eurocris:cerif-1.6-2
type	xs:float
properties	isRef 0 minOcc 0 maxOcc 1 content simple
source	<code><xs:element name="cfCount" type="xs:float" minOccurs="0"/></code>

complexType **cfResPubl_ResPubl_Type**

diagram	
namespace	urn:xmlns:org:eurocris:cerif-1.6-2
children	cfResPublId1 cfResPublId2 cfClassId cfClassSchemeld cfStartDate cfEndDate cfFraction
used by	element CERIF/cfResPubl_ResPubl
source	<code><xs:complexType name="cfResPubl_ResPubl_Type"> <xs:sequence> <xs:element name="cfResPublId1" type="cfId_Type"/> <xs:element name="cfResPublId2" type="cfId_Type"/> <xs:group ref="cfCoreClassWithFraction_Group"/> </xs:sequence> </xs:complexType></code>

element **cfResPubl_ResPubl_Type/cfResPublId1**

diagram	
namespace	urn:xmlns:org:eurocris:cerif-1.6-2
type	cfId_Type

properties	isRef 0 content simple
facets	Kind Value annotation maxLength 128
source	<code><xs:element name="cfResPublId1" type="cfId__Type"/></code>

element cfResPubl_ResPubl__Type/cfResPublId2

diagram	
namespace	urn:xmlns:org:eurocris:cerif-1.6-2
type	cfId__Type
properties	isRef 0 content simple
facets	Kind Value annotation maxLength 128
source	<code><xs:element name="cfResPublId2" type="cfId__Type"/></code>

complexType cfResPublAbstr__Type

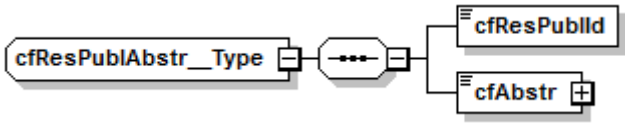
diagram	
namespace	urn:xmlns:org:eurocris:cerif-1.6-2
children	cfResPublId cfAbstr
used by	element CERIF/cfResPublAbstr
source	<code><xs:complexType name="cfResPublAbstr__Type"> <xs:sequence> <xs:element name="cfResPublId" type="cfId__Type"/> <xs:element name="cfAbstr" type="cfMLangString__Type"/> </xs:sequence> </xs:complexType></code>

element cfResPublAbstr__Type/cfResPublId

diagram	
namespace	urn:xmlns:org:eurocris:cerif-1.6-2
type	cfId__Type
properties	isRef 0 content simple
facets	Kind Value annotation maxLength 128
source	<code><xs:element name="cfResPublId" type="cfId__Type"/></code>

element **cfResPublAbstr__Type/cfAbstr**

diagram																			
namespace	urn.xmlns:org:eurocris:cerif-1.6-2																		
type	cfMLangString__Type																		
properties	isRef 0 content complex																		
attributes	<table border="1"> <thead> <tr> <th>Name</th> <th>Type</th> <th>Use</th> <th>Default</th> <th>Fixed</th> <th>annotation</th> </tr> </thead> <tbody> <tr> <td>cfLangCode</td> <td>xs:string</td> <td>required</td> <td></td> <td></td> <td></td> </tr> <tr> <td>cfTrans</td> <td>cfTrans__Type</td> <td>required</td> <td></td> <td></td> <td></td> </tr> </tbody> </table>	Name	Type	Use	Default	Fixed	annotation	cfLangCode	xs:string	required				cfTrans	cfTrans__Type	required			
Name	Type	Use	Default	Fixed	annotation														
cfLangCode	xs:string	required																	
cfTrans	cfTrans__Type	required																	
source	<code><xs:element name="cfAbstr" type="cfMLangString__Type"/></code>																		

complexType **cfResPublBiblNote__Type**

diagram	
namespace	urn.xmlns:org:eurocris:cerif-1.6-2
children	cfResPublId cfBiblNote
used by	element CERIF/cfResPublBiblNote
source	<pre> <xs:complexType name="cfResPublBiblNote__Type"> <xs:sequence> <xs:element name="cfResPublId" type="cfId__Type"/> <xs:element name="cfBiblNote" type="cfMLangString__Type"/> </xs:sequence> </xs:complexType> </pre>

element **cfResPublBiblNote__Type/cfResPublId**

diagram							
namespace	urn.xmlns:org:eurocris:cerif-1.6-2						
type	cfId__Type						
properties	isRef 0 content simple						
facets	<table border="1"> <thead> <tr> <th>Kind</th> <th>Value</th> <th>annotation</th> </tr> </thead> <tbody> <tr> <td>maxLength</td> <td>128</td> <td></td> </tr> </tbody> </table>	Kind	Value	annotation	maxLength	128	
Kind	Value	annotation					
maxLength	128						
source	<code><xs:element name="cfResPublId" type="cfId__Type"/></code>						

element **cfResPublBiblNote__Type/cfBiblNote**

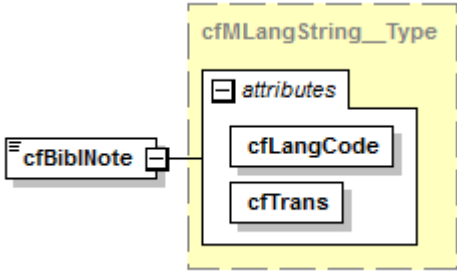
diagram																			
namespace	urn:xmlns:org:eurocris:cerif-1.6-2																		
type	cfMLangString__Type																		
properties	isRef 0 content complex																		
attributes	<table border="1"> <thead> <tr> <th>Name</th> <th>Type</th> <th>Use</th> <th>Default</th> <th>Fixed</th> <th>annotation</th> </tr> </thead> <tbody> <tr> <td>cfLangCode</td> <td>xs:string</td> <td>required</td> <td></td> <td></td> <td></td> </tr> <tr> <td>cfTrans</td> <td>cfTrans__Type</td> <td>required</td> <td></td> <td></td> <td></td> </tr> </tbody> </table>	Name	Type	Use	Default	Fixed	annotation	cfLangCode	xs:string	required				cfTrans	cfTrans__Type	required			
Name	Type	Use	Default	Fixed	annotation														
cfLangCode	xs:string	required																	
cfTrans	cfTrans__Type	required																	
source	<code><xs:element name="cfBiblNote" type="cfMLangString__Type"/></code>																		

complexType **cfResPublKeyw__Type**

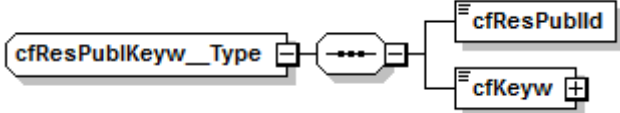
diagram	
namespace	urn:xmlns:org:eurocris:cerif-1.6-2
children	cfResPublId cfKeyw
used by	element CERIF/cfResPublKeyw
source	<code><xs:complexType name="cfResPublKeyw__Type"> <xs:sequence> <xs:element name="cfResPublId" type="cfId__Type"/> <xs:element name="cfKeyw" type="cfMLangString__Type"/> </xs:sequence> </xs:complexType></code>

element **cfResPublKeyw__Type/cfResPublId**

diagram							
namespace	urn:xmlns:org:eurocris:cerif-1.6-2						
type	cfId__Type						
properties	isRef 0 content simple						
facets	<table border="1"> <thead> <tr> <th>Kind</th> <th>Value</th> <th>annotation</th> </tr> </thead> <tbody> <tr> <td>maxLength</td> <td>128</td> <td></td> </tr> </tbody> </table>	Kind	Value	annotation	maxLength	128	
Kind	Value	annotation					
maxLength	128						
source	<code><xs:element name="cfResPublId" type="cfId__Type"/></code>						

element **cfResPublKeyw__Type/cfKeyw**

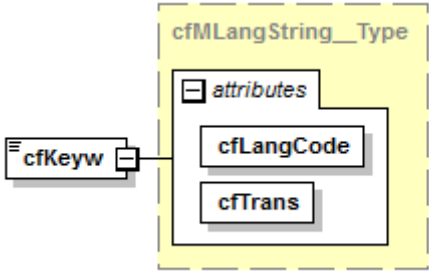
diagram																			
namespace	urn:xmlns:org:eurocris:cerif-1.6-2																		
type	cfMLangString__Type																		
properties	isRef 0 content complex																		
attributes	<table border="1"> <thead> <tr> <th>Name</th> <th>Type</th> <th>Use</th> <th>Default</th> <th>Fixed</th> <th>annotation</th> </tr> </thead> <tbody> <tr> <td>cfLangCode</td> <td>xs:string</td> <td>required</td> <td></td> <td></td> <td></td> </tr> <tr> <td>cfTrans</td> <td>cfTrans__Type</td> <td>required</td> <td></td> <td></td> <td></td> </tr> </tbody> </table>	Name	Type	Use	Default	Fixed	annotation	cfLangCode	xs:string	required				cfTrans	cfTrans__Type	required			
Name	Type	Use	Default	Fixed	annotation														
cfLangCode	xs:string	required																	
cfTrans	cfTrans__Type	required																	
source	<code><xs:element name="cfKeyw" type="cfMLangString__Type"/></code>																		

complexType **cfResPublNameAbbrev__Type**

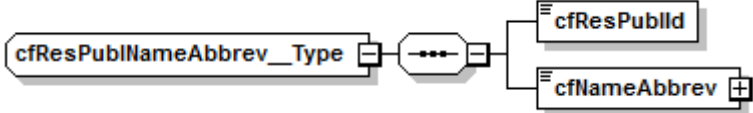
diagram	
namespace	urn:xmlns:org:eurocris:cerif-1.6-2
children	cfResPublId cfNameAbbrev
used by	element CERIF/cfResPublNameAbbrev
source	<code><xs:complexType name="cfResPublNameAbbrev__Type"> <xs:sequence> <xs:element name="cfResPublId" type="cfId__Type"/> <xs:element name="cfNameAbbrev" type="cfMLangString__Type"/> </xs:sequence> </xs:complexType></code>

element **cfResPublNameAbbrev__Type/cfResPublId**

diagram							
namespace	urn:xmlns:org:eurocris:cerif-1.6-2						
type	cfId__Type						
properties	isRef 0 content simple						
facets	<table border="1"> <thead> <tr> <th>Kind</th> <th>Value</th> <th>annotation</th> </tr> </thead> <tbody> <tr> <td>maxLength</td> <td>128</td> <td></td> </tr> </tbody> </table>	Kind	Value	annotation	maxLength	128	
Kind	Value	annotation					
maxLength	128						
source	<code><xs:element name="cfResPublId" type="cfId__Type"/></code>						

element **cfResPublNameAbbrev__Type/cfNameAbbrev**

diagram																			
namespace	urn:xmlns:org:eurocris:cerif-1.6-2																		
type	cfMLangString__Type																		
properties	isRef 0 content complex																		
attributes	<table border="1"> <thead> <tr> <th>Name</th> <th>Type</th> <th>Use</th> <th>Default</th> <th>Fixed</th> <th>annotation</th> </tr> </thead> <tbody> <tr> <td>cfLangCode</td> <td>xs:string</td> <td>required</td> <td></td> <td></td> <td></td> </tr> <tr> <td>cfTrans</td> <td>cfTrans__Type</td> <td>required</td> <td></td> <td></td> <td></td> </tr> </tbody> </table>	Name	Type	Use	Default	Fixed	annotation	cfLangCode	xs:string	required				cfTrans	cfTrans__Type	required			
Name	Type	Use	Default	Fixed	annotation														
cfLangCode	xs:string	required																	
cfTrans	cfTrans__Type	required																	
source	<code><xs:element name="cfNameAbbrev" type="cfMLangString__Type"/></code>																		

complexType **cfResPublSubtitle__Type**

diagram	
namespace	urn:xmlns:org:eurocris:cerif-1.6-2
children	cfResPublId cfSubtitle
used by	element CERIF/cfResPublSubtitle
source	<pre> <xs:complexType name="cfResPublSubtitle__Type"> <xs:sequence> <xs:element name="cfResPublId" type="cfId__Type"/> <xs:element name="cfSubtitle" type="cfMLangString__Type"/> </xs:sequence> </xs:complexType> </pre>

element **cfResPublSubtitle__Type/cfResPublId**

diagram							
namespace	urn:xmlns:org:eurocris:cerif-1.6-2						
type	cfId__Type						
properties	isRef 0 content simple						
facets	<table border="1"> <thead> <tr> <th>Kind</th> <th>Value</th> <th>annotation</th> </tr> </thead> <tbody> <tr> <td>maxLength</td> <td>128</td> <td></td> </tr> </tbody> </table>	Kind	Value	annotation	maxLength	128	
Kind	Value	annotation					
maxLength	128						
source	<code><xs:element name="cfResPublId" type="cfId__Type"/></code>						

element **cfResPublSubtitle__Type/cfSubtitle**

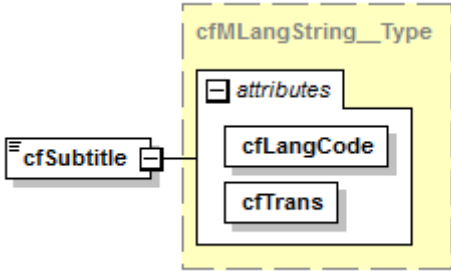
diagram																			
namespace	urn:xmlns:org:eurocris:cerif-1.6-2																		
type	cfMLangString__Type																		
properties	isRef 0 content complex																		
attributes	<table border="1"> <thead> <tr> <th>Name</th> <th>Type</th> <th>Use</th> <th>Default</th> <th>Fixed</th> <th>annotation</th> </tr> </thead> <tbody> <tr> <td>cfLangCode</td> <td>xs:string</td> <td>required</td> <td></td> <td></td> <td></td> </tr> <tr> <td>cfTrans</td> <td>cfTrans__Type</td> <td>required</td> <td></td> <td></td> <td></td> </tr> </tbody> </table>	Name	Type	Use	Default	Fixed	annotation	cfLangCode	xs:string	required				cfTrans	cfTrans__Type	required			
Name	Type	Use	Default	Fixed	annotation														
cfLangCode	xs:string	required																	
cfTrans	cfTrans__Type	required																	
source	<code><xs:element name="cfSubtitle" type="cfMLangString__Type"/></code>																		

complexType **cfResPublTitle__Type**

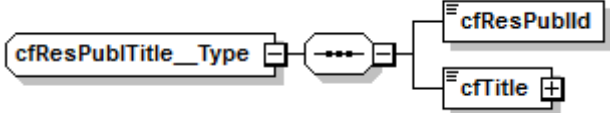
diagram	
namespace	urn:xmlns:org:eurocris:cerif-1.6-2
children	cfResPublId cfTitle
used by	element CERIF/cfResPublTitle
source	<pre><xs:complexType name="cfResPublTitle__Type"> <xs:sequence> <xs:element name="cfResPublId" type="cfId__Type"/> <xs:element name="cfTitle" type="cfMLangString__Type"/> </xs:sequence> </xs:complexType></pre>

element **cfResPublTitle__Type/cfResPublId**

diagram							
namespace	urn:xmlns:org:eurocris:cerif-1.6-2						
type	cfId__Type						
properties	isRef 0 content simple						
facets	<table border="1"> <thead> <tr> <th>Kind</th> <th>Value</th> <th>annotation</th> </tr> </thead> <tbody> <tr> <td>maxLength</td> <td>128</td> <td></td> </tr> </tbody> </table>	Kind	Value	annotation	maxLength	128	
Kind	Value	annotation					
maxLength	128						
source	<code><xs:element name="cfResPublId" type="cfId__Type"/></code>						

element **cfResPublTitle__Type/cfTitle**

diagram																			
namespace	urn.xmlns:org:eurocris:cerif-1.6-2																		
type	cfMLangString__Type																		
properties	isRef 0 content complex																		
attributes	<table border="1"> <thead> <tr> <th>Name</th> <th>Type</th> <th>Use</th> <th>Default</th> <th>Fixed</th> <th>annotation</th> </tr> </thead> <tbody> <tr> <td>cfLangCode</td> <td>xs:string</td> <td>required</td> <td></td> <td></td> <td></td> </tr> <tr> <td>cfTrans</td> <td>cfTrans__Type</td> <td>required</td> <td></td> <td></td> <td></td> </tr> </tbody> </table>	Name	Type	Use	Default	Fixed	annotation	cfLangCode	xs:string	required				cfTrans	cfTrans__Type	required			
Name	Type	Use	Default	Fixed	annotation														
cfLangCode	xs:string	required																	
cfTrans	cfTrans__Type	required																	
source	<code><xs:element name="cfTitle" type="cfMLangString__Type"/></code>																		

complexType **cfResPublVersInfo__Type**

diagram	
namespace	urn.xmlns:org:eurocris:cerif-1.6-2
children	cfResPublId cfVersInfo
used by	element CERIF/cfResPublVersInfo
source	<pre> <xs:complexType name="cfResPublVersInfo__Type"> <xs:sequence> <xs:element name="cfResPublId" type="cfId__Type"/> <xs:element name="cfVersInfo" type="cfMLangString__Type"/> </xs:sequence> </xs:complexType> </pre>

element **cfResPublVersInfo__Type/cfResPublId**

diagram							
namespace	urn.xmlns:org:eurocris:cerif-1.6-2						
type	cfId__Type						
properties	isRef 0 content simple						
facets	<table border="1"> <thead> <tr> <th>Kind</th> <th>Value</th> <th>annotation</th> </tr> </thead> <tbody> <tr> <td>maxLength</td> <td>128</td> <td></td> </tr> </tbody> </table>	Kind	Value	annotation	maxLength	128	
Kind	Value	annotation					
maxLength	128						
source	<code><xs:element name="cfResPublId" type="cfId__Type"/></code>						

element **cfResPublVersInfo__Type/cfVersInfo**

diagram																			
namespace	urn:xmlns:org:eurocris:cerif-1.6-2																		
type	cfMLangString__Type																		
properties	isRef 0 content complex																		
attributes	<table border="1"> <thead> <tr> <th>Name</th> <th>Type</th> <th>Use</th> <th>Default</th> <th>Fixed</th> <th>annotation</th> </tr> </thead> <tbody> <tr> <td>cfLangCode</td> <td>xs:string</td> <td>required</td> <td></td> <td></td> <td></td> </tr> <tr> <td>cfTrans</td> <td>cfTrans__Type</td> <td>required</td> <td></td> <td></td> <td></td> </tr> </tbody> </table>	Name	Type	Use	Default	Fixed	annotation	cfLangCode	xs:string	required				cfTrans	cfTrans__Type	required			
Name	Type	Use	Default	Fixed	annotation														
cfLangCode	xs:string	required																	
cfTrans	cfTrans__Type	required																	
source	<code><xs:element name="cfVersInfo" type="cfMLangString__Type"/></code>																		

simpleType **cfGender__Type**

namespace	urn:xmlns:org:eurocris:cerif-1.6-2												
type	restriction of xs:string												
properties	base xs:string												
used by	element cfPers__Type/cfGender												
facets	<table border="1"> <thead> <tr> <th>Kind</th> <th>Value</th> <th>annotation</th> </tr> </thead> <tbody> <tr> <td>enumeration</td> <td>m</td> <td>documentation Male</td> </tr> <tr> <td>enumeration</td> <td>f</td> <td>documentation Female</td> </tr> <tr> <td>enumeration</td> <td>u</td> <td>documentation Unknown</td> </tr> </tbody> </table>	Kind	Value	annotation	enumeration	m	documentation Male	enumeration	f	documentation Female	enumeration	u	documentation Unknown
Kind	Value	annotation											
enumeration	m	documentation Male											
enumeration	f	documentation Female											
enumeration	u	documentation Unknown											
source	<pre> <xs:simpleType name="cfGender__Type"> <xs:restriction base="xs:string"> <xs:enumeration value="m"> <xs:annotation> <xs:documentation>Male</xs:documentation> </xs:annotation> </xs:enumeration> <xs:enumeration value="f"> <xs:annotation> <xs:documentation>Female</xs:documentation> </xs:annotation> </xs:enumeration> <xs:enumeration value="u"> <xs:annotation> <xs:documentation>Unknown</xs:documentation> </xs:annotation> </xs:enumeration> </xs:restriction> </xs:simpleType> </pre>												

simpleType **cfId__Type**

namespace	urn:xmlns:org:eurocris:cerif-1.6-2
type	restriction of xs:string
properties	base xs:string

used by	<p>elements</p> <p>cfCiteDescr Type/cfCiteId cfCiteTitle Type/cfCiteId cfCite Type/cfCiteId cfResPubl Type/cfResPubl Cite/cfCiteId cfResPubl Cite Type/cfCiteId cfCite Class Type/cfCiteId cfFedId EmbType/cfClassId cfClassTerm Type/cfClassId cfClassEx Type/cfClassId cfFund Indic Type/cfClassId cfFund Meas Type/cfClassId cfClassScheme Type/cfClass/cfClassId cfCoreClass Group/cfClassId cfClassDescr Type/cfClassId cfClassDef Type/cfClassId cfClass Type/cfClass Class/cfClassId1 cfClassScheme Type/cfClass/cfClass Class/cfClassId1 cfClass Class Type/cfClassId1 cfClass Type/cfClass Class/cfClassId2 cfClassScheme Type/cfClass/cfClass Class/cfClassId2 cfClass Class Type/cfClassId2 cfClassSchemeDescr Type/cfClassSchemeld cfFedId EmbType/cfClassSchemeld cfFund Meas Type/cfClassSchemeld cfFund Indic Type/cfClassSchemeld cfClassScheme Type/cfClassSchemeld cfClassTerm Type/cfClassSchemeld cfClassEx Type/cfClassSchemeld cfClassSchemeName Type/cfClassSchemeld cfClassDef Type/cfClassSchemeld cfCoreClass Group/cfClassSchemeld cfClassDescr Type/cfClassSchemeld cfClassScheme ClassScheme Type/cfClassSchemeld1 cfClass Type/cfClass Class/cfClassSchemeld1 cfClassScheme Type/cfClass/cfClass Class/cfClassSchemeld1 cfClassScheme Type/cfClassScheme ClassScheme/cfClassSchemeld1 cfClass Class Type/cfClassSchemeld1 cfClassScheme Type/cfClassScheme ClassScheme/cfClassSchemeld2 cfClassScheme Type/cfClass/cfClass Class/cfClassSchemeld2 cfClass Type/cfClass Class/cfClassSchemeld2 cfClass Class Type/cfClassSchemeld2 cfClassScheme ClassScheme Type/cfClassSchemeld2 cfCV Type/cfCVId cfCV Class Type/cfCVId cfPers Type/cfPers CV/cfCVId cfPers CV Type/cfCVId cfEAddr Class Type/cfEAddrId cfPers Type/cfPers EAddr/cfEAddrId cfOrgUnit Type/cfOrgUnit EAddr/cfEAddrId cfPers EAddr Type/cfEAddrId cfOrgUnit EAddr Type/cfEAddrId cfEAddr Type/cfEAddrId cfEvent Type/cfEventId cfResPubl Event Type/cfEventId cfFund Type/cfEvent Fund/cfEventId cfProj Event Type/cfEventId cfOrgUnit Type/cfOrgUnit Event/cfEventId cfEventName Type/cfEventId cfOrgUnit Event Type/cfEventId cfEventDescr Type/cfEventId cfEventKeyw Type/cfEventId cfResPubl Type/cfResPubl Event/cfEventId cfEvent Class Type/cfEventId cfEvent Fund Type/cfEventId cfPers Type/cfPers Event/cfEventId cfEvent Indic Type/cfEventId cfEvent Meas Type/cfEventId cfMeas Type/cfEvent Meas/cfEventId cfPers Event Type/cfEventId cfIndic Type/cfEvent Indic/cfEventId cfProj Type/cfProj Event/cfEventId cfEvent Event Type/cfEventId1 cfEvent Type/cfEvent Event/cfEventId1 cfEvent Type/cfEvent Event/cfEventId2 cfEvent Event Type/cfEventId2 cfFedId Class Type/cfFedIdId cfFedId EmbType/cfFedIdId cfFedId Type/cfFedIdId cfOrgUnit Type/cfOrgUnit Fund/cfFundId cfResPubl Fund Type/cfFundId cfEvent Type/cfEvent Fund/cfFundId cfEvent Fund Type/cfFundId cfFund Meas Type/cfFundId cfFundName Type/cfFundId cfPers Type/cfPers Fund/cfFundId cfFundDescr Type/cfFundId cfFund Class Type/cfFundId cfResPubl Type/cfResPubl Fund/cfFundId cfFundKeyw Type/cfFundId cfProj Type/cfProj Fund/cfFundId cfOrgUnit Fund Type/cfFundId cfFund Indic Type/cfFundId cfPers Fund Type/cfFundId cfIndic Type/cfFund Indic/cfFundId cfFund Type/cfFundId cfMeas Type/cfFund Meas/cfFundId cfProj Fund Type/cfFundId cfFund Fund Type/cfFundId1 cfFund Type/cfFund Fund/cfFundId1 cfFund Fund Type/cfFundId2 cfFund Type/cfFund Fund/cfFundId2 cfEvent Indic Type/cfIndicId cfMeas Type/cfIndic Meas/cfIndicId cfFund Indic Type/cfIndicId cfOrgUnit Type/cfOrgUnit Indic/cfIndicId cfPers Type/cfPers Indic/cfIndicId cfResPubl Indic Type/cfIndicId cfProj Indic Type/cfIndicId cfOrgUnit Indic Type/cfIndicId cfPers Indic Type/cfIndicId cfIndicKeyw Type/cfIndicId cfIndicName Type/cfIndicId cfIndic Class Type/cfIndicId cfFund Type/cfFund Indic/cfIndicId cfIndic Meas Type/cfIndicId cfResPubl Type/cfResPubl Indic/cfIndicId cfIndic Type/cfIndicId cfEvent Type/cfEvent Indic/cfIndicId cfProj Type/cfProj Indic/cfIndicId cfIndicDescr Type/cfIndicId cfIndic Indic Type/cfIndicId1 cfIndic Type/cfIndic Indic/cfIndicId1 cfIndic Indic Type/cfIndicId2 cfIndic Type/cfIndic Indic/cfIndicId2 cfFedId Type/cfInstId cfMeas Meas Type/cfMeasId1 cfMeas Type/cfMeas Meas/cfMeasId1 cfOrgUnit Type/cfOrgUnit Meas/cfMeasId cfPers Type/cfPers Meas/cfMeasId cfProj Type/cfProj Meas/cfMeasId cfMeas Type/cfMeasId cfResPubl Type/cfResPubl Meas/cfMeasId cfIndic Type/cfIndic Meas/cfMeasId cfIndic Meas Type/cfMeasId cfEvent Type/cfEvent Meas/cfMeasId cfMeas Class Type/cfMeasId cfMeasName Type/cfMeasId cfMeasDescr Type/cfMeasId cfMeasKeyw Type/cfMeasId cfPers Meas Type/cfMeasId cfFund Type/cfFund Meas/cfMeasId cfOrgUnit Meas Type/cfMeasId cfProj Meas Type/cfMeasId cfEvent Meas Type/cfMeasId cfFund Meas Type/cfMeasId cfResPubl Meas Type/cfMeasId cfMeas Meas Type/cfMeasId2 cfMeas Type/cfMeas Meas/cfMeasId2 cfResPubl Type/cfResPubl Metrics/cfMetricsId cfMetricsKeyw Type/cfMetricsId cfMetricsName Type/cfMetricsId cfMetricsDescr Type/cfMetricsId cfResPubl Metrics Type/cfMetricsId cfMetrics Class Type/cfMetricsId cfMetrics Type/cfMetricsId cfDC Type/cfOrgUnit DC/cfOrgUnitId cfOrgUnitResAct Type/cfOrgUnitId cfProj Type/cfProj OrgUnit/cfOrgUnitId cfEvent Type/cfOrgUnit Event/cfOrgUnitId cfOrgUnitKeyw Type/cfOrgUnitId cfOrgUnit Class Type/cfOrgUnitId cfOrgUnit EAddr Type/cfOrgUnitId cfFund Type/cfOrgUnit Fund/cfOrgUnitId</p>
---------	--

	<p>cfOrgUnit_Event_Type/cfOrgUnitId cfOrgUnit_Fund_Type/cfOrgUnitId cfOrgUnit_Type/cfOrgUnitId cfOrgUnit_ResPubl_Type/cfOrgUnitId cfPers_Type/cfPers_OrgUnit/cfOrgUnitId cfOrgUnit_Indic_Type/cfOrgUnitId cfEAddr_Type/cfOrgUnit_EAddr/cfOrgUnitId cfPAddr_Type/cfOrgUnit_PAddr/cfOrgUnitId cfOrgUnit_Meas_Type/cfOrgUnitId cfOrgUnit_PAddr_Type/cfOrgUnitId cfProj_OrgUnit_Type/cfOrgUnitId cfResPubl_Type/cfOrgUnit_ResPubl/cfOrgUnitId cfMeas_Type/cfOrgUnit_Meas/cfOrgUnitId cfPers_OrgUnit_Type/cfOrgUnitId cfIndic_Type/cfOrgUnit_Indic/cfOrgUnitId cfOrgUnitName_Type/cfOrgUnitId cfOrgUnit_DC_Type/cfOrgUnitId cfOrgUnit_Type/cfOrgUnit_OrgUnit/cfOrgUnitId1 cfOrgUnit_OrgUnit_Type/cfOrgUnitId1 cfOrgUnit_OrgUnit_Type/cfOrgUnitId2 cfOrgUnit_Type/cfOrgUnit_OrgUnit/cfOrgUnitId2 cfPAddr_Type/cfPAddrId cfOrgUnit_PAddr_Type/cfPAddrId cfEAddr_Type/cfPAddrId cfPers_Type/cfPers_PAddr/cfPAddrId cfOrgUnit_Type/cfOrgUnit_PAddr/cfPAddrId cfPers_PAddr_Type/cfPAddrId cfPAddr_Class_Type/cfPAddrId cfCountry_Type/cfPers_Country/cfPersId cfCV_Type/cfPers_CV/cfPersId cfPers_ResPubl_Type/cfPersId cfEvent_Type/cfPers_Event/cfPersId cfIndic_Type/cfPers_Indic/cfPersId cfPers_OrgUnit_Type/cfPersId cfFund_Type/cfPers_Fund/cfPersId cfPers_Lang_Type/cfPersId cfPers_Fund_Type/cfPersId cfResPubl_Type/cfPers_ResPubl/cfPersId cfOrgUnit_Type/cfPers_OrgUnit/cfPersId cfPers_Event_Type/cfPersId cfPers_CV_Type/cfPersId cfLang_Type/cfPers_Lang/cfPersId cfPers_Class_Type/cfPersId cfPers_EAddr_Type/cfPersId cfPers_Meas_Type/cfPersId cfEAddr_Type/cfPers_EAddr/cfPersId cfPAddr_Type/cfPers_PAddr/cfPersId cfPers_PAddr_Type/cfPersId cfPers_Indic_Type/cfPersId cfPersKeyw_Type/cfPersId cfPersResInt_Type/cfPersId cfPers_Type/cfPersId cfDC_Type/cfPers_DC/cfPersId cfProj_Pers_Type/cfPersId cfPers_DC_Type/cfPersId cfQual_Type/cfPers_Qual/cfPersId cfPers_Qual_Type/cfPersId cfPersName_Type/cfPersName_Pers/cfPersId cfPersName_Pers_Type/cfPersId cfPers_Country_Type/cfPersId cfProj_Type/cfProj_Pers/cfPersId cfMeas_Type/cfPers_Meas/cfPersId cfPers_Pers_Type/cfPersId1 cfPers_Type/cfPers_Pers/cfPersId1 cfPers_Type/cfPers_Pers/cfPersId2 cfPers_Pers_Type/cfPersId2 cfPersName_Type/cfPersNameId cfPersName_Pers_Type/cfPersNameId cfPers_Type/cfPersName_Pers/cfPersNameId cfEvent_Type/cfProj_Event/cfProjId cfOrgUnit_Type/cfProj_OrgUnit/cfProjId cfFund_Type/cfProj_Fund/cfProjId cfProj_ResPubl_Type/cfProjId cfResPubl_Type/cfProj_ResPubl/cfProjId cfProj_Indic_Type/cfProjId cfProj_Pers_Type/cfProjId cfProj_OrgUnit_Type/cfProjId cfProj_Fund_Type/cfProjId cfProjTitle_Type/cfProjId cfProj_Meas_Type/cfProjId cfDC_Type/cfProj_DC/cfProjId cfProj_Class_Type/cfProjId cfProj_Type/cfProjId cfIndic_Type/cfProj_Indic/cfProjId cfProjAbstr_Type/cfProjId cfPers_Type/cfProj_Pers/cfProjId cfProjKeyw_Type/cfProjId cfProj_Event_Type/cfProjId cfMeas_Type/cfProj_Meas/cfProjId cfProj_DC_Type/cfProjId cfProj_Proj_Type/cfProjId1 cfProj_Type/cfProj_Proj/cfProjId1 cfProj_Type/cfProj_Proj/cfProjId2 cfProj_Proj_Type/cfProjId2 cfQualDescr_Type/cfQualId cfQual_Class_Type/cfQualId cfQualKeyw_Type/cfQualId cfPers_Qual_Type/cfQualId cfQualTitle_Type/cfQualId cfQual_Type/cfQualId cfPers_Type/cfPers_Qual/cfQualId cfResPubl_Indic_Type/cfResPublId cfIndic_Type/cfResPubl_Indic/cfResPublId cfResPubl_Event_Type/cfResPublId cfFund_Type/cfResPubl_Fund/cfResPublId cfOrgUnit_Type/cfOrgUnit_ResPubl/cfResPublId cfResPublAbstr_Type/cfResPublId cfPers_Type/cfPers_ResPubl/cfResPublId cfResPubl_Class_Type/cfResPublId cfResPublNameAbbrev_Type/cfResPublId cfResPublKeyw_Type/cfResPublId cfResPubl_Meas_Type/cfResPublId cfResPubl_Fund_Type/cfResPublId cfOrgUnit_ResPubl_Type/cfResPublId cfMetrics_Type/cfResPubl_Metrics/cfResPublId cfCite_Type/cfResPubl_Cite/cfResPublId cfProj_ResPubl_Type/cfResPublId cfResPubl_DC_Type/cfResPublId cfResPublBiblNote_Type/cfResPublId cfMeas_Type/cfResPubl_Meas/cfResPublId cfProj_Type/cfProj_ResPubl/cfResPublId cfResPubl_Metrics_Type/cfResPublId cfPers_ResPubl_Type/cfResPublId cfResPubl_Cite_Type/cfResPublId cfResPublVersInfo_Type/cfResPublId cfResPubl_Type/cfResPublId cfResPublSubtitle_Type/cfResPublId cfDC_Type/cfResPubl_DC/cfResPublId cfEvent_Type/cfResPubl_Event/cfResPublId cfResPublTitle_Type/cfResPublId cfResPubl_Type/cfResPubl_ResPubl/cfResPublId1 cfResPubl_ResPubl_Type/cfResPublId1 cfResPubl_Type/cfResPubl_ResPubl/cfResPublId2 cfResPubl_ResPubl_Type/cfResPublId2 cfFedId_Type/cfFedId_Srv/cfSrvId</p>						
facets	<table border="1"> <tr> <td>Kind</td> <td>Value</td> <td>annotation</td> </tr> <tr> <td>maxLength</td> <td>128</td> <td></td> </tr> </table>	Kind	Value	annotation	maxLength	128	
Kind	Value	annotation					
maxLength	128						
source	<pre><xs:simpleType name="cfId__Type"> <xs:restriction base="xs:string"> <xs:maxLength value="128"/> </xs:restriction> </xs:simpleType></pre>						

simpleType cfTrans_Type

namespace	urn:xmlns.org:eurocris:cerif-1.6-2
type	restriction of xs:string

properties	base	xs:string
used by	attribute	cfMLangString_Type/@cfTrans
facets	Kind	Value annotation documentation Value in the original language
	enumeration	o
	enumeration	h documentation Human-translated value
	enumeration	m documentation Machine-translated value
source	<pre> <xs:simpleType name="cfTrans__Type"> <xs:restriction base="xs:string"> <xs:enumeration value="o"> <xs:annotation> <xs:documentation>Value in the original language</xs:documentation> </xs:annotation> </xs:enumeration> <xs:enumeration value="h"> <xs:annotation> <xs:documentation>Human-translated value</xs:documentation> </xs:annotation> </xs:enumeration> <xs:enumeration value="m"> <xs:annotation> <xs:documentation>Machine-translated value</xs:documentation> </xs:annotation> </xs:enumeration> </xs:restriction> </xs:simpleType> </pre>	